

A blurred image of a car's headlight and front end, showing motion blur in shades of yellow, green, and blue, set against a black background.

GONHER[®]
AUTOPARTES

CATÁLOGO FILTROS 2021







GONHER.CONTIGO

MÁXIMO EQUIPO



*Juntos somos imparables.
Gracias por ser parte de GONHER.*

GONHER® *En marcha contigo*

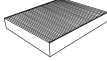
GONHER		ACEITE	SINTÉTICO	AIRE	COMB.	CABINA
AÑO	MOTOR					

ACURA

ILX

2019 - 2016	L4-2.4L	GP-149	GP-149 SNG			GAC-92
2015 - 2013	L4-2.0L	GP-149	GP-149 SNG	GA-1113 ⁽¹⁾		GAC-92

MDX

2020	V6-3.5L					GAC-92
2019 - 2014	V6-3.5L	GP-149	GP-149 SNG			GAC-92
2013 - 2011	V6-3.7L	GP-149	GP-149 SNG			GAC-92
2010 - 2007	V6-3.7L	GP-149	GP-149 SNG	GA-383		GAC-92
2006-2005	V6-3.5L	GP-149	GP-149 SNG	GA-385		

RDX

2020 - 2019	L4-2.0L Turbo	GP-149	GP-149 SNG			
2018 - 2013	V6-3.5L	GP-149	GP-149 SNG			GAC-92
2012 - 2007	L4-2.3L Turbo	GP-149	GP-149 SNG			GAC-92

RL

2011 - 2009	V6-3.7L	GP-149	GP-149 SNG			GAC-92
2008-2005	V6-3.5L	GP-149	GP-149 SNG	GA-269		GAC-92

RLX

2020 - 2016	V6-3.5L					GAC-92
2015 - 2014	V6-3.5L	GP-149	GP-149 SNG			GAC-92

RSX

2006-2002	L4-2.0L			GA-184		GAC-2274 ⁽¹⁾
-----------	---------	--	--	--------	--	-------------------------

TL

2013 - 2011	V6-3.7L	GP-149	GP-149 SNG	GA-171		GAC-92
2013 - 2008	V6-3.5L	GP-149	GP-149 SNG	GA-171		GAC-92
2009	V6-3.7L	GP-149	GP-149 SNG	GA-171		GAC-92
2008-2007	V6-3.2L	GP-149	GP-149 SNG			GAC-92
2006-2004	V6-3.2L	GP-149	GP-149 SNG	GA-269		GAC-92
2003-1999	V6-3.2L	GP-149	GP-149 SNG	GA-170		
1998 - 1996	V6-3.2L	GP-149	GP-149 SNG			

TLX

2020 - 2016	V6-3.5L	GP-149	GP-149 SNG	GA-191		GAC-92
2020	L4-2.4L					GAC-92
2019 - 2015	L4-2.4L	GP-149	GP-149 SNG	GA-190		GAC-92
2015	V6-3.5L	GP-149	GP-149 SNG	GA-191		

TSX

2014 - 2010	V6-3.5L	GP-149	GP-149 SNG	GA-171		GAC-92
2014 - 2009	L4-2.4L	GP-149	GP-149 SNG			GAC-92
2008-2004	L4-2.4L	GP-149	GP-149 SNG	GA-138		GAC-92

ZDX

2013 - 2011	V6-3.7L	GP-149	GP-149 SNG			GAC-92
2010	V6-3.7L	GP-149	GP-149 SNG	GA-383		GAC-92

ALFA ROMEO

147





2007	L4-2.0L	GP-291				
2005-2002	L4-2.0L	GP-291				

156

2004-2002	L4-2.0L	GP-291				
-----------	---------	--------	--	--	--	--

(1) Nuevo

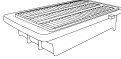
Los filtros Gonher prolongan la vida útil del motor evitando el desgaste prematuro.
Para vehículos anteriores a 1990, consulte nuestro catálogo web en www.grupogonher.com

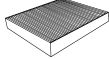
GONHER		ACEITE	SINTÉTICO	AIRE	COMB.	CABINA
AÑO	MOTOR					

ALFA ROMEO (Continúa)

GIULIA

2018 - 2017	L4-2.0L Turbo	GP-406	GP-406 SNG			
-------------	---------------	--------	------------	--	--	--

MITO

2019 - 2015	L4-1.4L Turbo	G-713				
2013 - 2012	L4-1.4L Turbo	G-713				

STELVIO

2019 - 2017	L4-2.0L Turbo	GP-406	GP-406 SNG			
-------------	---------------	--------	------------	--	--	--

AUDI

A1

2018 - 2011	L4-1.4L Turbo	GP-561		GAVW-690	GG-1243	GAC-60
2018	L4-1.8L Turbo	G-784				GAC-60
2017	L4-1.8L Turbo	G-784	GP-28 SNG			GAC-60
2016	L4-1.8L Turbo	G-784				GAC-60

A3

2019 - 2018	L4-2.0L Turbo	G-784				GAC-60
2019 - 2016	L4-1.4L Turbo	GP-503		GAVW-692		GAC-60
2018	L4-1.8L Turbo	GP-28	GP-28 SNG			
2017	L4-2.0L Turbo	GP-28	GP-28 SNG	GAVW-692		GAC-60
2016	L4-1.8L Turbo	GP-503		GAVW-619		GAC-60
2015 - 2014	L4-1.8L Turbo	GP-28	GP-28 SNG	GAVW-619		GAC-60
2015 - 2013	L4-1.4L Turbo	G-562		GAVW-629		GAC-60
2013 - 2011	L4-2.0L Turbo	GP-407		GAVW-619	GG-1243	GAC-28
2013	L4-1.8L Turbo	GP-28	GP-28 SNG	GAVW-621		GAC-60
2012 - 2010	L4-1.4L Turbo	G-562		GAVW-629		
2012 - 2009	L4-1.8L Turbo	GP-28	GP-28 SNG	GAVW-621		
2011	L4-2.0L	GP-407		GAVW-619		
2010	L4-2.0L	GP-407, G-313		GAVW-619		
2010	L4-2.0L Turbo	GP-407, G-313		GAVW-619	GG-1243	GAC-28
2009	L4-1.4L Turbo	G-562		GAVW-629	GG-1243	
2009	L4-2.0L	GP-407, G-313		GAVW-617		
2009	L4-2.0L Turbo	GP-407, G-313		GAVW-617	GG-1243	GAC-28
2008-2006	L4-2.0L Turbo	G-313		GAVW-617	GG-1243	GAC-28
2008-2004	L4-2.0L	G-313		GAVW-617		
2008	L4-1.4L Turbo	G-562		GAVW-629		
2008	L4-1.8L Turbo	GP-28	GP-28 SNG	GA-2124		
2005-2004	L4-2.0L Turbo	G-313		GAVW-617		
2004-2003	L4-1.8L Turbo	GP-28	GP-28 SNG	GAVW-621	GG-251	
2002-1998	L4-1.8L Turbo	GP-28	GP-28 SNG	GAVW-621	GG-102	





A3 QUATTRO

2005-2004	V6-3.2L	G-466		GA-2124	GG-102	
-----------	---------	-------	--	---------	--------	--

A4

2017	L4-2.0L Turbo	GP-407				
2016 - 2014	L4-2.0L Turbo diésel	GP-407		GA-2124		
2016 - 2010	L4-2.0L Turbo	GP-407		GA-2232 ⁽¹⁾		
2016 - 2007	L4-1.8L Turbo	GP-28	GP-28 SNG	GA-2124		
2010	L4-2.0L	GP-407				
2009	L4-2.0L	GP-407, G-313				

(1) Nuevo

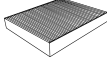
GONHER		ACEITE	SINTÉTICO	AIRE	COMB.	CABINA
AÑO	MOTOR					

AUDI (Continúa)

A4 (Continúa)

2009	L4-2.0L Turbo	GP-407, G-313		GA-2232 ⁽¹⁾		
2008-2007	L4-2.0L Turbo	G-313				
2008-2006	V6-3.2L	G-2310				
2007-2005	V6-3.2L	GP-1, G-2310		GA-2124		
2006	L4-1.8L Turbo	GP-3569		GA-2124		
2006	L4-2.0L Turbo	G-313		GA-2124		
2005-2002	L4-1.8L Turbo	GP-28	GP-28 SNG	GA-2124		
2001-1999	L4-1.8L Turbo	GP-28	GP-28 SNG	GAVW-622	GG-251	
1998-1997	L4-1.8L Turbo	GP-28	GP-28 SNG	GAVW-622	GG-408	
1997	V6-2.8L	GP-1		GAVW-622	GG-408	

A4 QUATTRO

2016-2010	L4-2.0L Turbo	GP-407				
2008-2006	L4-2.0L Turbo	G-313		GA-2124		
2008-2005	V6-3.2L			GA-2124		
2005-2003	L4-1.8L Turbo	GP-3569				
2002	L4-1.8L Turbo	GP-3569		GAVW-622		
2001-1999	L4-1.8L Turbo	GP-3569		GAVW-622	GG-251	
2001	V6-2.8L	GP-171		GAVW-622	GG-251	
1998-1997	V6-2.8L	GP-171		GAVW-622	GG-251	

A5

2018	L4-2.0L Turbo	GP-407				
2016-2015	L4-1.8L Turbo	GP-407				
2016-2015	V6-3.0L			GAVW-619		
2016-2011	L4-2.0L Turbo	GP-407		GA-2232 ⁽¹⁾		
2010-2008	V6-3.2L	G-2310				

A5 QUATTRO

2015-2011	L4-2.0L Turbo	GP-407				
-----------	---------------	--------	--	--	--	--

A6

2018-2016	L4-2.0L Turbo	G-784				
2018	L4-1.8L Turbo	G-784				
2014-2013	L4-2.0L Turbo	GP-407				
2011-2006	V6-3.2L	G-2310				
2006-2002	V6-3.0L	GP-171		GAVW-622	GG-408	
2001	V6-2.8L	GP-171		GAVW-622	GG-408	
2000-1999	V6-2.8L	GP-171		GAVW-622	GG-251	
1998	V6-2.8L	GP-171		GAVW-622	GG-246	





A6 QUATTRO

2010	V6-3.0L	GP-171		GAVW-622		
2006-2005	V6-3.0L	GP-171		GAVW-622		
2004-2002	V6-3.0L	GP-171		GAVW-622	GG-408	
2001	V6-2.8L	GP-171		GAVW-622	GG-408	
2000-1999	V6-2.8L	GP-171		GAVW-622	GG-251	
1998	V6-2.8L	GP-171		GAVW-622		

A8

2016-2015	V6-3.0L	G-2310				
2000	V8-3.7L	G-112		GA-2141	GG-408	

(1) Nuevo

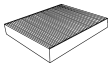
GONHER.		ACEITE	SINTÉTICO	AIRE	COMB.	CABINA
AÑO	MOTOR					

AUDI (Continúa)

A8 QUATTRO

2002 - 2000	V8-4.2L	G-112				
1999 - 1997	V8-4.2L			GA-2141		

ALLROAD

2016 - 2013	L4-2.0L Turbo			GA-2232 ⁽¹⁾		
-------------	---------------	--	--	------------------------	--	--

ALLROAD QUATTRO

2004 - 2002	V6-2.7L Turbo	GP-171		GAVW-622		
2001	V6-2.7L Turbo	GP-171		GAVW-622	GG-408	

CABRIOLET

1998 - 1997	V6-2.8L	GP-1		GAVW-120	GG-261	
-------------	---------	------	--	----------	--------	--

Q3

2019 - 2015	L4-2.0L Turbo	GP-407		GAVW-619		GAC-28
2018	L4-1.4L Turbo			GAVW-692		
2017 - 2016	L4-1.4L Turbo	GP-503		GAVW-692		GAC-28
2016 - 2013	L4-2.0L Turbo diésel	GP-407		GAVW-619		
2014 - 2013	L4-2.0L Turbo	GP-407		GAVW-619		

Q3 QUATTRO

2018 - 2017	L4-2.0L Turbo	GP-407		GAVW-619		
2017	L4-2.0L Turbo diésel	GP-407		GAVW-619		

Q5

2017 - 2011	L4-2.0L Turbo	GP-407		GA-2232 ⁽¹⁾		
2013	V6-3.0L Turbo diésel	G-362 ⁽¹⁾				
2011 - 2010	V6-3.2L	G-2310		GA-2232 ⁽¹⁾		

Q7

2019 - 2017	V6-3.0L	G-2310				
2017 - 2011	V6-3.0L	G-2310		GAVW-616		
2017 - 2008	V6-3.0L Turbo diésel			GAVW-616		
2015 - 2011	V6-3.0L	G-2310				
2011 - 2008	V8-4.2L Turbo diésel			GAVW-616		
2010 - 2007	V6-3.6L	G-112		GAVW-616		
2010 - 2007	V8-4.2L			GAVW-616		

RS3

2018	L5-2.5L Turbo	G-313				
------	---------------	-------	--	--	--	--

RS6

2004	V8-4.2L Turbo	GP-28	GP-28 SNG		GG-255	
------	---------------	-------	-----------	--	--------	--

S4

2018 - 2010	V6-3.0L	G-2310				
2001	V6-2.7L Turbo	GP-81	GP-81 SNG	GAVW-622	GG-408	
2000	V6-2.7L Turbo	GP-171		GAVW-622	GG-246	

S5

2018 - 2010	V6-3.0L	G-2310				
-------------	---------	--------	--	--	--	--





S6

2004	V8-4.2L			GAVW-622	GG-408	
2003-2002	V8-4.2L	GP-452		GAVW-622	GG-408	

S8

2002 - 2001	V8-4.2L	G-112		GA-2141	GG-408	
-------------	---------	-------	--	---------	--------	--

(1) Nuevo

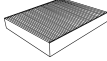
GONHER		ACEITE	SINTÉTICO	AIRE	COMB.	CABINA
AÑO	MOTOR					

AUDI (Continúa)

SQ5

2018 - 2014	V6-3.0L	G-2310				
-------------	---------	--------	--	--	--	--

TT

2014 - 2010	L4-2.0L Turbo	GP-407		GAVW-619		GAC-28
2009	L4-2.0L Turbo	GP-407		GAVW-619	GG-1243	GAC-28
2008	L4-2.0L Turbo	G-313		GAVW-617	GG-1243	GAC-28
2007	L4-2.0L	G-313				
2007	L4-2.0L Turbo	G-313				
2006-2000	L4-1.8L Turbo	GP-28	GP-28 SNG	GAVW-621	GG-102	GAC-10 ⁽⁶⁾ , GAC-8
1999	L4-1.8L Turbo	GP-28	GP-28 SNG	GAVW-621		

TT QUATTRO

2014 - 2010	L4-2.0L Turbo	GP-407			GG-1243	GAC-28
2013 - 2012	L5-2.5L Turbo	G-313			GG-1243	
2009-2008	V6-3.2L	G-70				GAC-28
2007	V6-3.2L	G-70				
2006	L4-1.8L Turbo			GAVW-621		GAC-28
2005-2000	L4-1.8L Turbo			GAVW-621		

BAIC

BJ20

2020	L4-1.5L	GP-58	GP-58 SNG			
2018	L4-1.5L Turbo	GP-58	GP-58 SNG			

BJ40

2018	L4-2.3L Turbo	GP-58	GP-58 SNG			
------	---------------	-------	-----------	--	--	--

D20

2020	L4-1.5L	GP-6811	GP-6811 SNG		GG-64	
2018 - 2017	L4-1.5L	GP-6811	GP-6811 SNG		GG-64	

X25

2020 - 2017	L4-1.5L	GP-6811	GP-6811 SNG		GG-64	
-------------	---------	---------	-------------	--	-------	--

X35

2019	L4-1.5L	GP-6811	GP-6811 SNG		GG-64	
------	---------	---------	-------------	--	-------	--

X65

2020 - 2018	L4-2.0L Turbo	GP-58	GP-58 SNG			
-------------	---------------	-------	-----------	--	--	--

BMW

125I

2013 - 2008	L6-3.0L			GA-2223 ⁽¹⁾		
-------------	---------	--	--	------------------------	--	--

128I

2013 - 2008	L6-3.0L			GA-232		
-------------	---------	--	--	--------	--	--

130I

2010 - 2006	L6-3.0L			GA-232		
-------------	---------	--	--	--------	--	--

320I





2005 - 2001	L6-2.2L	G-954		GA-2114		
-------------	---------	-------	--	---------	--	--

323I

2001	L6-2.5L	G-954		GA-2114		
2000	L6-2.5L	G-954		GA-2114	GG-351	
1999	L6-2.5L	G-954		GA-2114		

(1) Nuevo, (6) Con carbón activado

Los filtros Gonher prolongan la vida útil del motor evitando el desgaste prematuro.
Para vehículos anteriores a 1990, consulte nuestro catálogo web en www.grupogonher.com

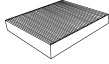
GONHER.		ACEITE	SINTÉTICO	AIRE	COMB.	CABINA
AÑO	MOTOR					
BMW (Continúa)						

323I (Continúa)

1998	L6-2.5L	G-954		GA-2114	GG-351	
1997	L6-2.5L	G-954		GA-2114		

323TI

2000-1999	L6-2.5L	G-954		GA-2114		
-----------	---------	-------	--	---------	--	--

325CI

2006-2001	L6-2.5L	G-954		GA-2114		
-----------	---------	-------	--	---------	--	--

325I

2013-2010	L6-2.5L			GA-2223 ⁽¹⁾		
2011	L6-3.0L Turbo			GA-232		
2009-2007	L6-2.5L	G-954		GA-2223 ⁽¹⁾		
2006-2001	L6-2.5L	G-954		GA-2114		
1997-1996	L6-2.5L	G-954		GA-2114		
1995	L6-2.5L	G-963		GA-2114	GG-251	

328I

2013-2012	L6-3.0L Turbo			GA-232		
2000-1996	L6-2.8L	G-954		GA-2114	GG-351	

330CI

2006	L6-3.0L	G-954		GA-232		
2005-2001	L6-3.0L	G-954		GA-2114		

330I

2007-2006	L6-3.0L	G-954		GA-232		
2005-2001	L6-3.0L	G-954		GA-2114		

525I

2010-2006	L6-2.5L	G-954		GA-2114		
2010	L6-3.0L	G-954		GA-2114		
2003-2001	L6-2.5L	G-954		GA-2114	GG-351	

528I

2000-1997	L6-2.8L	G-954		GA-2114	GG-351	
1996	L6-2.8L	G-954		GA-2114		

530I

2010-2004	L6-3.0L	G-954				
2003-2001	L6-3.0L	G-954		GA-2114		

540I

2003-2001	V8-4.4L	G-984		GAVW-622		
2000-1997	V8-4.4L	G-984		GAVW-622	GG-351	

550I

2010-2006	V8-4.8L	G-210				
-----------	---------	-------	--	--	--	--

740I

2001	V8-4.4L	G-984		GAVW-622		
2000-1998	V8-4.4L	G-984		GAVW-622	GG-351	

740IL





2001	V8-4.4L	G-984		GAVW-622		
2000	V8-4.4L	G-984		GAVW-622	GG-351	

745I

2005-2002	V8-4.4L			GA-241		
-----------	---------	--	--	--------	--	--

(1) Nuevo

Los filtros Gonher prolongan la vida útil del motor evitando el desgaste prematuro.
Para vehículos anteriores a 1990, consulte nuestro catálogo web en www.grupogonher.com

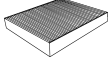
GONHER		ACEITE	SINTÉTICO	AIRE	COMB.	CABINA
AÑO	MOTOR					

BMW (Continúa)

745LI

2005 - 2003	V8-4.4L			GA-241		
-------------	---------	--	--	--------	--	--

750I

2009-2006	V8-4.8L	G-210		GA-241		
-----------	---------	-------	--	--------	--	--

750IL

2001 - 1996	V12 5.4L	G-984		GA-2105	GG-351	
1995	V12 5.4L	G-984		GA-2110		

750LI

2009-2006	V8-4.8L	G-210		GA-241		
-----------	---------	-------	--	--------	--	--

760LI

2009-2005	V12 6.0L	G-210		GA-241		
2004	V12 6.0L			GA-241		
2003	V12 6.0L	G-210		GA-241		

850CI

1999 - 1996	V12 5.4L	G-984		GA-2110		
1995	V12 5.4L			GA-2110		

M3

2006-2002	L6-3.2L	G-963		GA-2114		
2001	L6-3.2L	G-963		GA-2114	GG-351	
1999 - 1997	L6-3.2L	G-963		GA-2114	GG-351	
1996	L6-3.2L	G-963		GA-2114	GG-251	
1995	L6-3.0L	G-963		GA-2114	GG-251	

X1

2013 - 2010	L6-3.0L			GA-2223 ⁽¹⁾		
-------------	---------	--	--	------------------------	--	--

X3

2011 - 2008	L6-2.5L	G-954		GA-2114		
2010 - 2008	L6-3.0L			GA-2231 ⁽¹⁾		
2007	L6-3.0L	G-954		GA-2114, GA-2231		
2006-2004	L6-2.5L	G-954		GA-2114		
2006-2004	L6-3.0L	G-954		GA-2114		

X5





2010	V8-4.8L	G-210				
2009	L6-3.0L	G-954		GA-2105		
2009	V8-4.8L	G-210		GAVW-622		
2008-2007	V8-4.8L	G-210				
2006-2005	V8-4.4L			GAVW-622		
2006-2005	V8-4.8L			GAVW-622		
2006	L6-3.0L	G-954		GA-2105		
2005	L6-3.0L	G-954		GA-2114		
2004-2002	V8-4.4L	G-984		GAVW-622		
2004-2001	L6-3.0L	G-954		GA-2105		
2000	V8-4.4L	G-984		GAVW-622		

Z3

2002-2001	L6-2.2L	G-975		GA-2193		
2002-2001	L6-3.0L	G-954		GA-2114	GG-351	
2002-1998	L6-3.2L	G-963		GA-2114	GG-351	
2000-1997	L6-2.8L	G-954		GA-2114	GG-351	
2000	L6-2.0L	G-975		GA-2193		
1999	L4-1.9L	G-975		GA-2193		

(1) Nuevo

Los filtros Gonher prolongan la vida útil del motor evitando el desgaste prematuro.
Para vehículos anteriores a 1990, consulte nuestro catálogo web en www.grupogonher.com

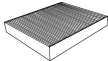
GONHER.		ACEITE	SINTÉTICO	AIRE	COMB.	CABINA
AÑO	MOTOR					

BMW (Continúa)

Z3 (Continúa)

1998 - 1996	L4-1.9L	G-975		GA-2193	GG-351	
-------------	---------	-------	--	---------	--------	--

Z4

2013	L6-3.0L			GA-4444 ⁽¹⁾		
2013	L6-3.0L Turbo			GA-4444 ⁽¹⁾		
2011 - 2008	L6-2.5L	G-954				
2011	L6-3.0L			GA-4444, GA-2217		
2011	L6-3.0L Turbo			GA-4444, GA-2217		
2010 - 2007	L6-3.0L			GA-2231 ⁽¹⁾		
2009 - 2007	L6-3.2L	G-963				
2007 - 2003	L6-2.5L	G-954		GA-2114		
2006	L6-3.0L			GA-2114		
2005 - 2003	L6-3.0L	G-954		GA-2114		

BUICK

CASCADA

2019 - 2016	L4-1.6L Turbo	G-3751				GAC-32
-------------	---------------	--------	--	--	--	--------

CENTURY

2005 - 1997	V6-3.1L	GP-46		GA-153	GG-46	
1996 - 1994	V6-3.1L	GP-46		GA-253	GG-41	
1993 - 1990	V6-3.1L	GP-46		GA-153	GG-46	
1992 - 1990	L4-2.5L			GA-3647		

ENCLAVE

2021	V6-3.6L					
2020	V6-3.6L			GA-2324		GAC-2336
2019 - 2018	V6-3.6L	GP-405	GP-405 SNG	GA-2324		GAC-2336
2017 - 2011	V6-3.6L	GP-405	GP-405 SNG	GA-3083		
2010 - 2008	V6-3.6L	GP-406	GP-406 SNG	GA-3083		

ENCORE

2020 - 2019	L4-1.4L Turbo	G-3751		GA-355		GAC-32
2018 - 2014	L4-1.4L Turbo	GP-2304 ⁽¹⁾		GA-355		GAC-32

ENVISION

2020 - 2017	L4-2.5L					GAC-2336
2020	L4-2.0L Turbo					GAC-2336
2019 - 2016	L4-2.0L Turbo	GP-406	GP-406 SNG			GAC-2336





LACROSSE

2019 - 2018	L4-2.5L Híbrido					GAC-2336 ⁽¹⁾
2019 - 2017	V6-3.6L					GAC-2336 ⁽¹⁾
2016	V6-3.6L	GP-405	GP-405 SNG			
2015 - 2011	V6-3.6L	GP-405	GP-405 SNG			GAC-32
2010	V6-3.6L	GP-406	GP-406 SNG			GAC-32
2007 - 2005	V6-3.6L	GP-406	GP-406 SNG			

LESABRE

2005 - 2004	V6-3.8L			GA-6479		
2003 - 2000	V6-3.8L	GP-46		GA-6479	GG-66	
1999 - 1993	V6-3.8L			GA-6479		

(1) Nuevo

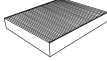
GONHER		ACEITE	SINTÉTICO	AIRE	COMB.	CABINA
AÑO	MOTOR					

BUICK (Continúa)

LUCERNE

2009 - 2006	V8-4.6L			GA-367		
2009	V6-3.9L			GA-367		
2008-2006	V6-3.8L			GA-367		

PARK AVENUE

2005-1993	V6-3.8L			GA-6479		
-----------	---------	--	--	---------	--	--

RAINIER

2007-2004	L6-4.2L	GP-3675		GA-414R	GG-209	
2007-2004	V8-5.3L	GP-3675		GA-414R	GG-209	

REGAL

2017 - 2014	L4-2.0L Turbo	GP-406	GP-406 SNG	GA-1251 ⁽¹⁾		GAC-32
2013	L4-2.0L Turbo	G-49				GAC-32
2004-1993	V6-3.8L	GP-46		GA-164	GG-66	

REGAL SPORTBACK

2020 - 2018	L4-2.0L Turbo					GAC-2336
2020 - 2018	V6-3.6L					GAC-2336

RIVIERA

1999 - 1995	V6-3.8L			GA-6479		
-------------	---------	--	--	---------	--	--

ROADMASTER

1996 - 1994	V8-5.7L			GA-6479		
-------------	---------	--	--	---------	--	--

SKYLARK

1991 - 1990	L4-2.5L			GA-3647		
-------------	---------	--	--	---------	--	--

TERRAZA

2007	V6-3.9L	GP-3675		GA-164		
------	---------	---------	--	--------	--	--

VERANO

2016 - 2014	L4-2.0L Turbo	G-49		GA-350		GAC-32
2016 - 2014	L4-2.4L	G-49		GA-294		GAC-32
2013	L4-2.0L Turbo	G-49		GA-294		GAC-32

CADILLAC

ALLANTE

1993	V8-4.6L			GA-6479		
------	---------	--	--	---------	--	--

ATS

2019 - 2018	V6-3.6L Turbo	GP-405	GP-405 SNG	GA-6313 ⁽¹⁾		
2019 - 2013	L4-2.0L Turbo	GP-406	GP-406 SNG			
2016	V6-3.6L Turbo	GP-405	GP-405 SNG	GA-6313 ⁽¹⁾		
2014 - 2013	L4-2.0L	GP-406	GP-406 SNG			

BLS

2008-2007	L4-2.0L Turbo					GAC-18
-----------	---------------	--	--	--	--	--------

CATERA





2001-2000	V6-3.0L	GP-46, G-45			GG-246	
1999 - 1997	V6-3.0L	GP-46, G-45		GA-145	GG-246	

CT4

2021 - 2020	L4-2.0L Turbo	GP-2351 ⁽¹⁾				
2021 - 2020	L4-2.7L Turbo	GP-2351 ⁽¹⁾				

(1) Nuevo

Los filtros Gonher prolongan la vida útil del motor evitando el desgaste prematuro.
Para vehículos anteriores a 1990, consulte nuestro catálogo web en www.grupogonher.com

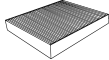
GONHER.		ACEITE	SINTÉTICO	AIRE	COMB.	CABINA
AÑO	MOTOR					

CADILLAC (Continúa)

CT5

2021 - 2020	L4-2.0L Turbo	GP-2351 ⁽¹⁾				
-------------	---------------	------------------------	--	--	--	--

CT6

2019	L4-2.0L Turbo	GP-2351 ⁽¹⁾				
------	---------------	------------------------	--	--	--	--

CTS

2019 - 2018	L4-2.0L Turbo	GP-406	GP-406 SNG			
2019 - 2015	V6-3.6L	GP-405	GP-405 SNG			
2017	L4-2.0L Turbo	GP-405	GP-405 SNG			
2016 - 2015	L4-2.0L Turbo	GP-406	GP-406 SNG			
2016	V8-6.2L	GP-406	GP-406 SNG			
2014 - 2012	V8-6.2L	GP-406	GP-406 SNG			
2014	V6-3.6L	GP-405	GP-405 SNG	GA-2234 ⁽¹⁾		
2013 - 2010	V6-3.0L	G-765		GA-2234 ⁽¹⁾		
2013 - 2008	V6-3.6L	G-765		GA-2234 ⁽¹⁾		
2009	V8-6.2L	GP-406	GP-406 SNG	GA-2234 ⁽¹⁾		
2007 - 2004	V6-3.6L	G-765				
2004 - 2003	V6-3.2L				GG-66	

DEVILLE

2005	V8-4.6L	GP-3675		GA-6479	GG-581	
2004 - 2001	V8-4.6L	GP-3675		GA-164	GG-66	
2000	V8-4.6L	GP-3675		GA-6479	GG-66	
1999 - 1994	V8-4.6L	GP-3675		GA-6479	GG-581	
1995	V8-4.9L	GP-3675		GA-6479		
1994 - 1993	V8-4.9L	GP-3675		GA-6479	GG-581	
1992 - 1991	V8-4.9L	GP-3429		GA-6479	GG-581	

DTS

2009 - 2006	V8-4.6L			GA-367		
-------------	---------	--	--	--------	--	--

ELDORADO

2002 - 1993	V8-4.6L	GP-3675		GA-6479	GG-581	
-------------	---------	---------	--	---------	--------	--

ELR

2016 - 2014	L4-1.4L Híbrido					GAC-32
-------------	-----------------	--	--	--	--	--------

ESCALADE

2021	L6-3.0L	GP-2351 ⁽¹⁾				
2019 - 2015	V8-6.2L	GP-405	GP-405 SNG	GA-348		
2014 - 2007	V8-6.2L	GP-406	GP-406 SNG	GA-348		
2009	V8-6.0L Híbrido	GP-3675		GA-348	GG-46	
2006 - 2003	V8-6.0L	GP-44		GA-348	GG-46	
2006 - 2002	V8-6.0L	GP-3675		GA-348	GG-46	
2000 - 1999	V8-5.7L			GA-732R		





ESCALADE ESV

2019 - 2015	V8-6.2L	GP-405	GP-405 SNG	GA-348		
2014 - 2007	V8-6.2L	GP-406	GP-406 SNG	GA-348		
2006 - 2004	V8-6.0L	GP-44		GA-348		
2003	V8-6.0L	GP-44		GA-348	GG-46	

ESCALADE EXT

2013 - 2007	V8-6.2L	GP-406	GP-406 SNG	GA-348		
2006 - 2004	V8-6.0L	GP-44		GA-348		
2003	V8-6.0L	GP-44		GA-348	GG-46	
2002	V8-6.0L	GP-3675		GA-348	GG-46	

(1) Nuevo

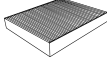
GONHER		ACEITE	SINTÉTICO	AIRE	COMB.	CABINA
AÑO	MOTOR					

CADILLAC (Continúa)

FLEETWOOD

1996 - 1994	V8-5.7L			GA-6479	GG-580	
1993	V8-5.7L				GG-580	

SEVILLE

2004	V8-4.6L	GP-3675		GA-164	GG-66	
2003	V8-4.6L	GP-46		GA-164	GG-66	
2002 - 2001	V8-4.6L	GP-3675		GA-6479	GG-581	
2000 - 1999	V8-4.6L	GP-46		GA-164	GG-66	
1998	V8-4.6L	GP-3675		GA-164	GG-66	
1997 - 1993	V8-4.6L	GP-3675		GA-6479	GG-581	

SRX

2016	V6-3.6L	GP-405	GP-405 SNG			
2015 - 2012	V6-3.6L	GP-405	GP-405 SNG			GAC-32
2011	V6-3.0L	GP-405	GP-405 SNG			GAC-32
2010	V6-3.0L	GP-406	GP-406 SNG			GAC-32
2009	V6-3.6L	GP-405	GP-405 SNG			
2007 - 2004	V8-4.6L	GP-3675				
2007	V6-3.6L	GP-405	GP-405 SNG			
2006 - 2004	V6-3.6L	G-765				

STS

2010 - 2005	V6-3.6L	G-765				
2010	V8-4.6L	GP-3675				
2009	V8-4.6L	GP-3675		GA-164		
2008	V8-4.6L	GP-3675				
2007 - 2005	V8-4.6L	GP-3675		GA-164		

XLR

2009	V8-4.6L	GP-3675		GA-164	GG-66	
2007 - 2004	V8-4.6L	GP-3675		GA-164	GG-66	

XT4

2021 - 2019	L4-2.0L Turbo	GP-2351 ⁽¹⁾				
-------------	---------------	------------------------	--	--	--	--

XT5

2021 - 2020	L4-2.0L Turbo	GP-2351 ⁽¹⁾		GA-2324		
2020 - 2017	V6-3.6L			GA-2324		
2019 - 2017	V6-3.6L	GP-405	GP-405 SNG	GA-2324		

XT6

2021	L4-2.0L Turbo	GP-2351 ⁽¹⁾		GA-2324		
2020	V6-3.6L			GA-2324		

XTS

2019 - 2014	V6-3.6L Turbo			GA-1251 ⁽¹⁾		
2019 - 2013	V6-3.6L			GA-1251 ⁽¹⁾		





CHEVROLET

ASTRA

2008 - 2007	L4-2.0L Turbo	GP-46		GA-234		
2008 - 2006	L4-1.8L	G-3751, GP-46		GA-234		
2008	L4-2.0L	GP-46		GA-234		
2006 - 2005	L4-2.4L	G-45		GA-334	GG-64	
2006	L4-2.0L	G-45		GA-334	GG-64	
2006	L4-2.0L Turbo	G-45		GA-334	GG-64	

(1) Nuevo

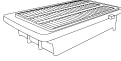
Los filtros Gonher prolongan la vida útil del motor evitando el desgaste prematuro.
Para vehículos anteriores a 1990, consulte nuestro catálogo web en www.grupogonher.com

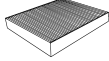
GONHER.		ACEITE	SINTÉTICO	AIRE	COMB.	CABINA
AÑO	MOTOR					

CHEVROLET (Continúa)

ASTRA (Continúa)

2005 - 2004	L4-2.0L	GP-46		GA-334	GG-64	
2004	L4-2.4L	GP-46		GA-334	GG-64	
2003 - 2002	L4-1.8L	GP-46		GA-234	GG-64	
2003 - 2001	L4-2.2L	G-49		GA-334	GG-64	
2001 - 2000	L4-1.8L	G-45		GA-234	GG-64	

ASTRO

2005 - 2001	V6-4.3L	GP-46		GA-165	GG-46	
2000 - 1997	V6-4.3L	GP-3980		GA-165	GG-46	
1996 - 1995	V6-4.3L			GA-165	GG-255	
1994 - 1993	V6-4.3L			GA-165, GA-3588	GG-46	
1990	L4-2.5L			GA-3647		

AVALANCHE

2013 - 2007	V8-5.3L	GP-406	GP-406 SNG	GA-348		
2009	V8-6.0L	GP-406	GP-406 SNG	GA-348		
2007	V8-6.0L	GP-406	GP-406 SNG	GA-348		

AVALANCHE 1500

2006	V8-5.3L	GP-44		GA-348	GG-252	
2005	V8-5.3L	GP-3675		GA-348	GG-252	
2004 - 2002	V8-5.3L	GP-44		GA-348	GG-252	

AVEO

2020 - 2018	L4-1.5L	GP-409		GA-9079 ⁽¹⁾	GG-2340 ⁽¹⁾	GAC-2331 ⁽¹⁾
2018 - 2012	L4-1.6L	GP-46		GA-324	GG-419	GAC-81
2011 - 2004	L4-1.6L	GP-46		GA-324	GG-419	GAC-2278 ⁽¹⁾

BEAT

2020 - 2018	L4-1.2L	GP-409		GA-330		
-------------	---------	--------	--	--------	--	--

BERETTA

1993	L4-2.3L	GP-46		GA-3916	GG-66	
1991 - 1990	L4-2.2L			GA-3647		

BLAZER





2021 - 2020	L4-2.0L Turbo	GP-2351 ⁽¹⁾		GA-2324		
2021 - 2019	L4-2.5L	GP-2304 ⁽¹⁾		GA-2324		
2021 - 2019	V6-3.6L			GA-2324		
2020 - 2019	V6-3.6L	GP-405	GP-405 SNG	GA-2324		
2005 - 1999	V6-4.3L	GP-3980		GA-165	GG-266	
2002	V6-4.2L	GP-3675		GA-414R	GG-209	
1998 - 1997	V6-4.3L	GP-3980		GA-165	GG-46	
1996 - 1995	V6-4.3L	GP-3980		GA-165	GG-3728	

C1500

2002 - 1999	V6-4.3L	GP-46		GA-348		
1999 - 1998	V8-5.7L			GA-732R		
1999 - 1996	V8-5.0L			GA-732R		
1998 - 1997	V6-4.3L	GP-46		GA-732R		
1998 - 1994	L6-4.1L	GP-3		GA-3523		
1997 - 1993	V8-5.7L	GP-5		GA-673R	GG-46	
1996 - 1994	V8-6.5L Turbo diésel			GA-392		
1996 - 1993	V6-4.3L	GP-46		GA-348		
1995 - 1994	V8-6.5L Diésel			GA-392		
1994	V8-6.5L Turbo diésel	GP-205		GA-392		
1993	V8-6.2L Diésel	GP-205		GA-3492	G-294	

(1) Nuevo

Los filtros Gonher prolongan la vida útil del motor evitando el desgaste prematuro.
Para vehículos anteriores a 1990, consulte nuestro catálogo web en www.grupogonher.com

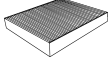
GONHER		ACEITE	SINTÉTICO	AIRE	COMB.	CABINA
AÑO	MOTOR					

CHEVROLET (Continúa)

C1500 (Continúa)

1991 - 1990	L6-4.1L	GP-3		GA-3523		
-------------	---------	------	--	---------	--	--

C1500 SUBURBAN

1999 - 1996	V8-5.7L			GA-732R		
1998 - 1997	V8-6.5L Diésel			GA-732R		
1996 - 1995	V8-6.5L Diésel			GA-392		

C2500

2000 - 1999	V8-6.5L Diésel			GA-732R		
2000 - 1999	V8-7.4L	GP-408		GA-732R		
2000	V8-5.7L	GP-205		GA-59	GG-46	
2000	V8-7.4L	GP-205		GA-673R	GG-46	
1999 - 1996	V8-5.7L	GP-205		GA-673R	GG-46	
1998 - 1997	V8-6.5L Turbo diésel			GA-732R		
1998 - 1997	V8-6.5L Turbo diésel	GP-205		GA-673R		
1998 - 1996	V8-5.0L			GA-732R		
1998 - 1996	V8-7.4L			GA-732R		
1996	V8-7.4L	GP-205		GA-673R	GG-46	
1995 - 1990	V8-5.7L	GP-205		GA-59	GG-46	
1994	V8-6.5L Diésel	GP-205		GA-392		
1993	V8-6.2L Diésel	GP-205		GA-3492	G-294	

C2500 SUBURBAN

1999 - 1996	V8-5.7L			GA-732R		
1999	V8-7.4L	GP-408		GA-732R		
1998 - 1996	V8-7.4L			GA-732R		

C35

2000 - 1990	V8-5.7L	GP-3		GA-59		
-------------	---------	------	--	-------	--	--

C3500





2004 - 2001	V8-5.7L	GP-205		GA-59		
2003 - 2001	V8-8.1L	GP-44		GA-732R		
2000 - 1996	V8-5.7L	GP-205		GA-732R		
2000	V8-7.4L			GA-732R		
1999	V8-7.4L	GP-408		GA-732R		
1998 - 1996	V8-7.4L			GA-732R		
1995 - 1993	V8-5.7L	GP-205		GA-59		
1994 - 1993	V8-7.4L	GP-205		GA-59	GG-46	
1993	V8-6.2L Diésel	GP-205		GA-3492	G-294	

CAMARO

2021	L4-2.0L Turbo	GP-2304 ⁽¹⁾				
2021	V8-6.2L	GP-2304 ⁽¹⁾				
2020 - 2018	V8-6.2L	GP-406, GP-2304	GP-406 SNG			
2020 - 2017	L4-2.0L Turbo	GP-406, GP-2304	GP-406 SNG			
2019 - 2016	V6-3.6L	GP-405	GP-405 SNG			
2018 - 2016	L4-2.0L Turbo	GP-2304 ⁽¹⁾				
2017 - 2016	V8-6.2L	GP-406, GP-2304	GP-406 SNG	GA-167		
2015 - 2010	V6-3.6L	G-765		GA-167		
2015 - 2010	V8-6.2L	GP-406	GP-406 SNG	GA-167		
2002 - 1999	V6-3.8L	GP-46		GA-165	GG-66	
2002 - 1999	V8-5.7L	GP-44		GA-392	GG-66	
1998 - 1993	V8-5.7L	GP-3		GA-165	GG-66	

(1) Nuevo

Los filtros Gonher prolongan la vida útil del motor evitando el desgaste prematuro.
Para vehículos anteriores a 1990, consulte nuestro catálogo web en www.grupogonher.com

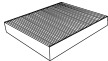
GONHER		ACEITE	SINTÉTICO	AIRE	COMB.	CABINA
AÑO	MOTOR					

CHEVROLET (Continúa)

CAMARO (Continúa)

1998	V6-3.8L	GP-46		GA-392	GG-66	
1997 - 1995	V6-3.8L	GP-46		GA-165	GG-66	
1995 - 1993	V6-3.4L			GA-165		

CAPRICE

1996 - 1994	V8-4.3L			GA-6479		
1996 - 1994	V8-5.7L	GP-3		GA-6479	GG-580	
1993	V8-5.7L	GP-3		GA-59	GG-580	

CAPTIVA SPORT

2015 - 2008	L4-2.4L	G-49		GA-290		
2015	V6-3.0L	GP-405	GP-405 SNG	GA-290		
2014 - 2011	V6-3.0L	GP-406	GP-406 SNG	GA-290		
2010 - 2008	V6-3.6L	GP-406	GP-406 SNG	GA-290		

CARGO VAN

2004-2003	V6-4.3L	GP-46		GA-392		
2004	V8-6.0L	GP-44		GA-413R		
2000-1997	V8-5.7L	GP-205		GA-392		
2000	V6-4.3L	GP-46		GA-392		

CAVALIER

2020 - 2018	L4-1.5L	GP-409		GA-1619 ⁽¹⁾	GG-2340	GAC-32
2005	L4-2.2L	GP-46		GA-3916	GG-66	
2004-2003	L4-2.2L			GA-3916		
2004-2003	L4-2.2L	G-49		GA-3916	GG-66	
2002 - 1997	L4-2.4L	GP-46		GA-3916	GG-66	
2002 - 1993	L4-2.2L	GP-46		GA-3916	GG-66	
1996	L4-2.4L	GP-44		GA-3916	GG-66	
1995	L4-2.4L	GP-46		GA-3916	GG-66	
1994 - 1993	V6-3.1L	GP-46		GA-253	GG-66	
1994 - 1990	V6-2.8L	GP-46		GA-153	GG-46	
1992 - 1991	V6-3.1L	GP-46		GA-253	GG-46	
1991 - 1990	L4-2.2L			GA-3647		

CELEBRITY

1990	L4-2.5L			GA-3647		
------	---------	--	--	---------	--	--

CHEVY

2012 - 1996	L4-1.6L	GP-46		GA-134	GG-64	
2005-2004	L4-1.6L	GP-46		GA-134	GG-64	GAC-18
2002 - 1994	L4-1.4L	GP-46		GA-134	GG-64	

CHEVY MONZA

2003	L4-1.6L	GP-46		GA-134	GG-64	GAC-18
------	---------	-------	--	--------	-------	--------

CHEVY PICKUP

2003	L4-1.6L	GP-46		GA-134	GG-64	GAC-18
2002 - 1999	L4-1.6L	GP-46		GA-134	GG-64	

CHEYENNE

2020-2007	V8-5.3L	GP-406	GP-406 SNG	GA-348	GG-46	
2019 - 2014	V8-6.2L	GP-405	GP-405 SNG	GA-348		





CITY EXPRESS

2018 - 2015	L4-2.0L	GP-91	GP-91 SNG	GAD-116		
-------------	---------	-------	-----------	---------	--	--

CLASSIC

2005-2004	L4-2.2L	G-49		GA-279	GG-66	
-----------	---------	------	--	--------	-------	--

(1) Nuevo

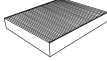
GONHER		ACEITE	SINTÉTICO	AIRE	COMB.	CABINA
AÑO	MOTOR					

CHEVROLET (Continúa)

COBALT

2010	L4-2.2L				GA-9969 ⁽¹⁾	
2009-2008	L4-2.0L Turbo	G-49				
2009-2005	L4-2.2L	G-49			GA-9969 ⁽¹⁾	
2008-2006	L4-2.4L	G-49			GA-9969 ⁽¹⁾	
2007-2006	L4-2.0L	G-49				
2007-2005	L4-2.2L				GA-9969 ⁽¹⁾	
2005	L4-2.0L	G-49			GA-414R	

COLORADO

2021 - 2016	L4-2.5L				GA-2314	
2021 - 2016	L4-2.8L Turbo diésel				GA-2314	
2021 - 2015	V6-3.6L				GA-2314	
2020 - 2016	L4-2.5L	GP-406, GP-2304	GP-406 SNG		GA-2314	
2020	V6-3.6L	GP-406	GP-406 SNG		GA-2314	
2019 - 2017	V6-3.6L	G-3751			GA-2314	
2016 - 2015	V6-3.6L	G-765			GA-2314	
2015	L4-2.5L	GP-2304			GA-2314	
2015	L4-2.5L				GA-2314	
2014 - 2013	V6-3.6L	G-765			GA-6262R	
2012 - 2011	L4-2.9L	GP-44			GA-266	
2012 - 2008	L5-3.7L	GP-3675			GA-266	
2009 - 2007	L4-2.9L	GP-44			GA-266	
2007	L4-2.9L	GP-44			GA-415	
2007	L5-3.7L	GP-3675			GA-415	
2006-2005	L5-3.5L	GP-3675			GA-415	GG-581
2006	L4-2.8L	GP-44			GA-415	
2005	L4-2.8L	GP-44			GA-415	GG-581
2004	L5-3.5L	GP-44			GA-415	GG-581

CORSA

2008-2003	L4-1.8L	GP-46			GA-289	GG-64	GAC-18
2002	L4-1.4L	GP-46			GA-289		GAC-18

CORVETTE

2021 - 2014	V8-6.2L	GP-2304 ⁽¹⁾					
2019 - 2014	V8-6.2L	GP-406, GP-2304	GP-406 SNG				
2013 - 2008	V8-6.2L	GP-406	GP-406 SNG				
2007 - 2005	V8-6.0L	GP-44			GA-1545		
2007	V8-6.0L	GP-406	GP-406 SNG		GA-1545		
2004 - 1999	V8-5.7L	GP-44			GA-392	GG-299	
1998 - 1997	V8-5.7L	GP-44			GA-392	GG-290	
1996	V8-5.7L	GP-3980			GA-7007	GG-46	
1995 - 1994	V8-5.7L	GP-3			GA-7007	GG-46	
1995 - 1992	V8-5.7L	GP-3985			GA-7007	GG-46	
1991	V8-5.7L	GP-3			GA-7007	GG-46	

CRUZE





2019 - 2017	L4-1.4L Turbo	GP-406, GP-2304	GP-406 SNG		GA-6313 ⁽¹⁾		
2019 - 2017	L4-1.6L Turbo diésel				GA-6313 ⁽¹⁾		
2016 - 2010	L4-1.8L	G-3751			GA-350		GAC-32
2016	L4-1.4L Turbo	GP-406, GP-2304	GP-406 SNG		GA-6313 ⁽¹⁾		GAC-32
2015 - 2014	L4-1.4L Turbo	G-3751			GA-294		GAC-32

(1) Nuevo

Los filtros Gonher prolongan la vida útil del motor evitando el desgaste prematuro.
Para vehículos anteriores a 1990, consulte nuestro catálogo web en www.grupogonher.com

FILTROS

CHEVROLET

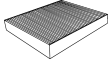
GONHER		ACEITE	SINTÉTICO	AIRE	COMB.	CABINA
AÑO	MOTOR					

CHEVROLET (Continúa)

EPICA

2009	L6-2.5L	GP-3675				
------	---------	---------	--	--	--	--

EQUINOX

2021	L4-1.5L Turbo	GP-2304 ⁽¹⁾				
2021	L4-2.0L Turbo	GP-2304 ⁽¹⁾				
2020 - 2018	L4-1.5L Turbo			GA-2315		
2020 - 2018	L4-2.0L Turbo			GA-2315		
2020	L4-1.5L Turbo	GP-406, GP-2304	GP-406 SNG	GA-2315		
2019 - 2018	L4-1.5L Turbo	GP-406, GP-2304	GP-406 SNG	GA-2315		GAC-32
2019 - 2018	L4-1.6L Turbo diésel			GA-2315		
2017 - 2013	V6-3.6L			GA-3138		
2017 - 2010	L4-2.4L	G-49		GA-3138		
2012 - 2010	V6-3.0L			GA-3138		
2009-2008	V6-3.6L			GA-367		
2009-2005	V6-3.4L	GP-46		GA-367		

EXPRESS 1500

2009	V6-4.3L	GP-3980		GA-392	GG-581	
2009	V8-5.3L	GP-44		GA-413R	GG-66	
2008-2007	V8-5.3L	GP-406	GP-406 SNG	GA-413R		
2008	V6-4.3L	GP-46		GA-413R		
2007-2005	V6-4.3L	GP-46		GA-413R	GG-581	
2007	V8-5.3L	GP-406	GP-406 SNG	GA-413R	GG-66	
2006-2003	V8-5.3L	GP-44		GA-413R	GG-66	
2004-2003	V6-4.3L	GP-46		GA-413R	GG-46	
2002-2001	V6-4.3L	GP-46		GA-413R	GG-581	
2002-2001	V8-5.7L	GP-205		GA-413R	GG-581	
2000-1996	V8-5.7L	GP-205		GA-392	GG-581	
2000	V6-4.3L	GP-46		GA-392	GG-581	
1999-1996	V6-4.3L	GP-3980		GA-392	GG-581	

EXPRESS 2500

2009	V8-6.6L Turbo diésel	GP-9100				
2007-2006	V8-6.6L Turbo diésel	GP-9100				
2006	V8-6.0L	GP-44		GA-413R		
2002-1996	V8-5.7L	GP-205		GA-392	GG-581	





EXPRESS 3500

2009-2006	V8-6.6L Turbo diésel	GP-9100				
2009-2003	V8-6.0L	GP-44		GA-413R	GG-46	
2008-2003	V8-5.3L	GP-44		GA-413R		
2004	V8-4.8L	GP-44		GA-413R		
2002-2001	V8-5.7L	GP-205		GA-413R	GG-581	
2001	V8-8.1L	GP-408		GA-413R	GG-581	
2000-1996	V8-5.7L	GP-205		GA-392	GG-581	
2000	V8-7.4L	GP-205		GA-392	GG-581	

EXPRESS CARGO

2017-2016	V8-6.0L	GP-406	GP-406 SNG			
2015-2010	V8-6.0L	GP-406	GP-406 SNG	GA-413R		
2014-2009	V6-4.3L	GP-46		GA-413R		
2009	V8-5.3L	GP-46		GA-413R		

(1) Nuevo

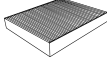
GONHER		ACEITE	SINTÉTICO	AIRE	COMB.	CABINA
AÑO	MOTOR					

CHEVROLET (Continúa)

EXPRESS PASAJEROS

2017 - 2016	V8-6.0L	GP-406	GP-406 SNG			
2015 - 2009	V8-6.0L	GP-406	GP-406 SNG	GA-413R		
2015	V8-5.3L	GP-406	GP-406 SNG	GA-413R		
2014 - 2009	V8-5.3L	GP-406	GP-406 SNG	GA-348		

G10

1993	V6-4.3L	GP-3980		GA-192	GG-46	
------	---------	---------	--	--------	-------	--

G20

1995 - 1994	V8-6.5L Diésel	GP-205		GA-392		
1995 - 1993	V6-4.3L	GP-3980		GA-192	GG-46	
1994	V8-5.7L	GP-205		GA-192	GG-46	

G30

2002 - 2001	V6-4.3L	GP-46				
1996 - 1993	V6-4.3L	GP-46				
1995 - 1994	V8-6.5L Diésel	GP-205		GA-392		
1994	V8-7.4L	GP-205		GA-59	GG-46	

HHR

2009-2006	L4-2.4L	G-49		GA-298		
-----------	---------	------	--	--------	--	--

IMPALA

2020 - 2018	V6-3.6L	GP-405	GP-405 SNG	GA-1251 ⁽¹⁾		
2019 - 2018	L4-2.5L	GP-406	GP-406 SNG	GA-1251 ⁽¹⁾		
2017 - 2014	L4-2.5L			GA-1251 ⁽¹⁾		
2006	V6-3.5L	GP-3675				
2005-2000	V6-3.4L	GP-46				
2005-2000	V6-3.8L	GP-46		GA-8754	GG-66	
1996 - 1995	V8-5.7L	GP-3		GA-6479	GG-580	

K1500

1999 - 1996	V8-5.7L			GA-732R		
-------------	---------	--	--	---------	--	--

K2500

2000 - 1999	V8-7.4L	GP-408				
2000	V8-7.4L	GP-408		GA-673R	GG-46	
1996	V8-5.7L	GP-3980		GA-673R	GG-46	
1994	V8-6.5L Turbo diésel			GA-3492		
1993	V8-6.2L Diésel	GP-205		GA-3492	G-294	

K2500 SUBURBAN

1999	V8-7.4L	GP-408				
1995 - 1994	V8-6.5L Diésel			GA-3492		

K3500





2000 - 1999	V8-7.4L	GP-408				
1999	V8-7.4L	GP-205		GA-673R	GG-46	
1996	V8-5.7L	GP-3980		GA-673R	GG-46	
1994 - 1993	V8-5.7L	GP-3980		GA-59	GG-46	
1994	V8-6.5L Diésel			GA-3492		
1994	V8-7.4L	GP-205		GA-59	GG-46	
1993	V8-6.2L Diésel	GP-205		GA-3492	G-294	
1993	V8-6.5L Turbo diésel			GA-3492		

LUMINA

1999 - 1994	V6-3.1L	GP-3980		GA-3588	GG-177	
1993	V6-3.1L	GP-46, GP-3980		GA-6626	GG-66	

(1) Nuevo

Los filtros Gonher prolongan la vida útil del motor evitando el desgaste prematuro.
Para vehículos anteriores a 1990, consulte nuestro catálogo web en www.grupogonher.com

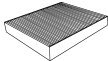
GONHER		ACEITE 	SINTÉTICO 	AIRE 	COMB. 	CABINA 
AÑO	MOTOR					

CHEVROLET (Continúa)

LUMINA APV

1995 - 1993	V6-3.1L			GA-3588		
-------------	---------	--	--	---------	--	--

LUV

2005-2002	L4-2.2L	GP-6811	GP-6811 SNG	GA-198	GG-167	
2001 - 1998	L4-2.2L	GP-6811	GP-6811 SNG	GA-198		
1997	L4-2.3L	GP-6811	GP-6811 SNG	GA-139	GG-46	

MALIBU

2018 - 2016	L4-1.5L Turbo	GP-406	GP-406 SNG, GP-2304			
2018	L4-2.0L Turbo	GP-406	GP-406 SNG			GAC-32
2016	L4-2.0L Turbo	GP-406	GP-406 SNG	GA-1251 ⁽¹⁾		
2015 - 2013	L4-2.0L Turbo	GP-406	GP-406 SNG	GA-1251 ⁽¹⁾		GAC-32
2015 - 2013	L4-2.5L	GP-406	GP-406 SNG	GA-1251 ⁽¹⁾		GAC-32
2012 - 2008	L4-2.4L	G-49		GA-367		
2012 - 2008	V6-3.6L	GP-406	GP-406 SNG	GA-367		
2009-2008	L4-2.4L Híbrido	G-49		GA-367		
2009	V6-3.5L	GP-46		GA-164		
2008-2007	V6-3.5L	GP-3675		GA-9948 ⁽¹⁾		
2008-2004	L4-2.2L	G-49		GA-164	GG-66	
2007-2006	V6-3.9L			GA-9948 ⁽¹⁾		
2006-2004	V6-3.5L	GP-46		GA-164		
2003 - 1997	V6-3.1L	GP-46		GA-279	GG-66	
1999 - 1997	L4-2.4L	GP-44		GA-279	GG-66	

MATIZ

2015 - 2011	L4-1.0L	GP-157		GA-323	GG-419	GAC-42
-------------	---------	--------	--	--------	--------	--------

MERIVA

2008	L4-1.8L	GP-46		GA-289	GG-64	
2007-2004	L4-1.8L	GP-46		GA-289	GG-64	GAC-18

ONIX

2021 - 2020	L3-1.0L Turbo	GP-2304 ⁽¹⁾		GA-2320 ⁽¹⁾		GAC-2333 ⁽¹⁾
2021 - 2020	L3-1.2L Turbo	GP-2304 ⁽¹⁾		GA-2320 ⁽¹⁾		GAC-2333 ⁽¹⁾

OPTRA

2010	L4-2.0L	GP-46		GA-328		
2009-2006	L4-2.0L	GP-46		GA-328	GG-419	

P30





2005-2002	V8-5.7L	GP-205		GA-70		
2005 - 1998	L6-4.1L	GP-3980		GA-70		
2001	V6-4.3L	GP-205		GA-392		
2000 - 1999	V8-5.7L	GP-205		GA-70		
1999	V8-6.5L Diésel	GP-205		GA-3492		
1998 - 1997	V8-5.7L	GP-3980		GA-392	GG-46	
1998 - 1994	V8-6.5L Diésel			GA-3492		
1997 - 1995	V6-4.3L	GP-205		GA-392		
1996 - 1990	V8-5.7L	GP-205		GA-70	GG-46	
1996	V8-5.7L			GA-70		
1995	V8-6.5L Diésel	GP-205		GA-3492		
1994 - 1993	V6-4.3L	GP-3980		GA-192	GG-46	
1993	V8-6.2L Diésel			GA-3492		
1992 - 1990	V8-5.7L			GA-70		

PRIZM

2002 - 1998	L4-1.8L			GA-5466		
-------------	---------	--	--	---------	--	--

(1) Nuevo

Los filtros Gonher prolongan la vida útil del motor evitando el desgaste prematuro.
Para vehículos anteriores a 1990, consulte nuestro catálogo web en www.grupogonher.com

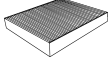
GONHER		ACEITE	SINTÉTICO	AIRE	COMB.	CABINA
AÑO	MOTOR					

CHEVROLET (Continúa)

S10

2017 - 2016	L4-2.5L	GP-406	GP-406 SNG	GA-6262R	GG-64	
2004 - 1993	V6-4.3L			GA-165		
2003-2000	L4-2.2L	GP-46		GA-165	GG-845	
1999	L4-2.2L	GP-46		GA-165		
1998 - 1994	L4-2.2L	GP-46		GA-165	GG-46	
1993 - 1991	V6-3.1L	GP-46		GA-3588	GG-3728	
1993 - 1990	V6-2.8L				GG-3728	
1993	L4-2.5L	GP-406	GP-406 SNG	GA-6262R	GG-64	
1993	V6-2.8L			GA-3588	GG-3728	
1990	L4-2.5L			GA-3647		

S10 BLAZER

1994 - 1991	V6-3.1L	GP-3		GA-59		
-------------	---------	------	--	-------	--	--

SILVERADO

1999	V8-5.7L	GP-205		GA-673R		
1998 - 1995	V8-5.7L	GP-3		GA-59		

SILVERADO 1500

2021 - 2020	L6-3.0L Turbo diésel	GP-2351 ⁽¹⁾				
2021	L4-2.7L Turbo	GP-2351 ⁽¹⁾				
2020 - 2019	L4-2.7L Turbo	GP-2351 ⁽¹⁾		GA-2321		
2020 - 2019	V6-4.3L			GA-2321		
2020 - 2019	V8-5.3L			GA-2321		
2020 - 2019	V8-6.2L			GA-2321		
2019	V6-4.3L	GP-405	GP-405 SNG	GA-348, GA-2321		
2018 - 2014	V6-4.3L	GP-405	GP-405 SNG	GA-348		
2013 - 2009	V6-4.3L	GP-46		GA-348		
2009 - 1999	V8-4.8L	GP-406	GP-406 SNG			
2009 - 1999	V8-5.3L	GP-406	GP-406 SNG	GA-348		
2008	V6-4.3L	GP-405	GP-405 SNG	GA-348		
2006	V6-4.3L	GP-46		GA-348		
2005-2002	V6-4.3L	GP-46		GA-348	GG-46	
2004	V8-5.3L	GP-44				
2001 - 1999	V6-4.3L	GP-405	GP-405 SNG	GA-348		
2001	V8-4.8L	GP-44, GP-3675		GA-348	GG-46	

SILVERADO 1500 LD





2019	V8-5.3L			GA-2321		
------	---------	--	--	---------	--	--

SILVERADO 2500

2018 - 2017	V8-5.3L	GP-405	GP-405 SNG	GA-348		
2017	V6-4.3L	GP-405	GP-405 SNG	GA-348		
2016 - 2007	V8-5.3L	GP-406	GP-406 SNG	GA-348		
2013 - 2008	V8-4.8L	GP-406	GP-406 SNG	GA-348		
2007-2006	V8-4.8L	GP-44		GA-348		
2006 - 1999	V8-5.3L	GP-44		GA-348		
2004	V8-6.0L	GP-44		GA-348		
2003	V8-6.0L	GP-44		GA-348	GG-46	
2002 - 2001	V8-5.7L	GP-44		GA-348		
2002	V8-6.0L	GP-44, GP-3675		GA-348	GG-46	
2000	V8-5.3L	GP-44, GP-3675		GA-348	GG-46	
2000	V8-5.7L	GP-205		GA-673R		

(1) Nuevo

Los filtros Gonher prolongan la vida útil del motor evitando el desgaste prematuro.
Para vehículos anteriores a 1990, consulte nuestro catálogo web en www.grupogonher.com

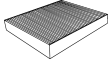
GONHER		ACEITE 	SINTÉTICO 	AIRE 	COMB. 	CABINA 
AÑO	MOTOR					

CHEVROLET (Continúa)

SILVERADO 2500 (Continúa)

1999	V8-6.0L	GP-44, GP-3675		GA-348	GG-46	
------	---------	-------------------	--	--------	-------	--

SILVERADO 2500 HD

2009 - 2001	V8-6.6L Turbo diésel	GP-9100		GA-348		
2006 - 2001	V8-8.1L	GP-408				

SILVERADO 3500

2018 - 2015	V8-6.0L	GP-406	GP-406 SNG	GA-348		
2013 - 2008	V8-6.0L	GP-406	GP-406 SNG	GA-348		
2007	V8-5.7L	GP-406	GP-406 SNG	GA-348		
2006 - 2001	V8-6.0L	GP-406	GP-406 SNG	GA-348		
2006 - 2001	V8-6.6L Turbo diésel	GP-9100		GA-348		
2006	V8-5.7L	GP-44		GA-348		
2005 - 2004	V8-5.7L	GP-205		GA-348		

SILVERADO 3500 HD

2009 - 2007	V8-6.6L Turbo diésel	GP-9100				
2007	V8-6.0L	GP-406	GP-406 SNG	GA-348		

SONIC

2020 - 2014	L4-1.4L Turbo	G-3751		GA-344		GAC-32
2017 - 2012	L4-1.6L	G-3751		GA-344	GG-419	GAC-32

SONORA

2006 - 2003	V8-5.3L	GP-3675		GA-348	GG-46	
2002 - 2000	V8-5.7L	GP-205		GA-348	GG-46	

SPARK

2020 - 2016	L4-1.4L	GP-2304 ⁽¹⁾				
2020	L4-1.4L	GP-406, GP-2304	GP-406 SNG	GA-310		
2019 - 2016	L4-1.4L	GP-406, GP-2304	GP-406 SNG	GA-310		GAC-32
2015 - 2014	L4-1.2L	GP-409		GA-330		GAC-32
2013 - 2011	L4-1.2L	GP-409		GA-330		

SPARK CLASSIC

2017 - 2016	L4-1.2L	GP-409		GA-330		
-------------	---------	--------	--	--------	--	--

SSR

2006 - 2005	V8-6.0L	GP-44			GG-209	
2004 - 2003	V8-5.3L	GP-44			GG-209	





SUBURBAN

2021	L6-3.0L	GP-2351 ⁽¹⁾				
2020 - 2014	V8-5.3L	GP-405	GP-405 SNG	GA-348		
2018 - 2016	V8-6.0L	GP-406	GP-406 SNG	GA-348		
1994 - 1990	V8-5.7L	GP-13		GA-59		

SUBURBAN 1500

2013 - 2010	V8-6.0L	GP-406	GP-406 SNG	GA-348		
2013 - 2007	V8-5.3L	GP-406	GP-406 SNG	GA-348		
2006	V8-5.3L	GP-44		GA-348		
2005 - 2000	V8-5.3L	GP-44		GA-348	GG-46	
2002	V8-5.7L	GP-44		GA-348		
2001 - 1995	V8-5.7L	GP-205		GA-348		

(1) Nuevo

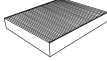
GONHER		ACEITE	SINTÉTICO	AIRE	COMB.	CABINA
AÑO	MOTOR					

CHEVROLET (Continúa)

SUBURBAN 2500

2009 - 2000	V8-6.0L	GP-406	GP-406 SNG	GA-348		
2006 - 2001	V8-8.1L	GP-408				
2006	V8-6.0L	GP-3675		GA-348		
2005	V8-8.1L	GP-408		GA-348		

TAHOE

2021	L6-3.0L	GP-2351 ⁽¹⁾				
2020 - 2019	V8-6.2L	GP-405	GP-405 SNG	GA-348		
2020 - 2015	V8-5.3L	GP-405	GP-405 SNG	GA-348		
2014 - 2000	V8-5.3L	GP-406	GP-406 SNG	GA-348		
1999	V8-6.5L Turbo diésel	GP-205		GA-673R		

TIGRA

1999	L4-1.6L	GP-46				
------	---------	-------	--	--	--	--

TORNADO

2020 - 2012	L4-1.8L	GP-46		GA-346	GG-64	
2011 - 2004	L4-1.8L	GP-46		GA-289	GG-64	GAC-18

TRACKER

2008 - 1999	L4-2.0L	GP-156	GP-156 SNG	GA-244	GG-206	
2004 - 2001	V6-2.5L	GP-2951				
2000 - 1998	L4-1.6L	GP-58	GP-58 SNG	GA-7617	GG-151	
2000	L4-1.6L	GP-156	GP-156 SNG	GA-244	GG-206	

TRAILBLAZER

2021	L3-1.3L	GP-2351 ⁽¹⁾				
2009 - 2006	V8-6.0L			GA-414R		
2009 - 2002	L6-4.2L	GP-3675		GA-414R	GG-209	
2007 - 2006	V8-5.3L			GA-414R		
2007	V8-5.3L	GP-406	GP-406 SNG	GA-414R		

TRAILBLAZER EXT

2005 - 2003	V8-5.3L				GG-209	
-------------	---------	--	--	--	--------	--

TRAVERSE

2020 - 2018	V6-3.6L			GA-2324		
2019 - 2018	L4-2.0L Turbo			GA-2324		
2019 - 2018	V6-3.6L	GP-405	GP-405 SNG	GA-2324		GAC-32
2017 - 2011	V6-3.6L	GP-405	GP-405 SNG	GA-3083		
2010 - 2009	V6-3.6L	GP-406	GP-406 SNG	GA-3083		

TRAX

2020 - 2013	L4-1.8L	G-3751		GA-355		GAC-32
2015 - 2014	L4-1.4L Turbo	G-3751		GA-355		GAC-32

UPLANDER

2009 - 2006	V6-3.9L	GP-3675		GA-164		
2006 - 2005	V6-3.5L	GP-46		GA-164		





VECTRA

2005 - 2003	L4-2.2L	G-49		GA-397		GAC-18
2005 - 2003	V6-3.2L	G-49		GA-397		GAC-18

VENTURE

2005 - 1997	V6-3.4L	GP-46		GA-164	GG-290	
-------------	---------	-------	--	--------	--------	--

(1) Nuevo

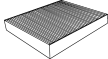
GONHER		ACEITE	SINTÉTICO	AIRE	COMB.	CABINA
AÑO	MOTOR					

CHEVROLET (Continúa)

VOLT

2019 - 2016	L4-1.5L Híbrido	GP-2304 ⁽¹⁾				
2019 - 2016	L4-1.5L Híbrido	GP-406, GP-2304	GP-406 SNG			GAC-32

ZAFIRA

2006-2002	L4-1.8L	GP-46		GA-234	GG-64	
2006-2002	L4-2.2L	G-49		GA-334	GG-64	

CHRYSLER

200

2016 - 2015	L4-2.4L	GP-406	GP-406 SNG	GA-2233 ⁽¹⁾		
2016 - 2015	V6-3.6L	G-349		GA-2233 ⁽¹⁾		
2014 - 2012	L4-2.4L	GP-406	GP-406 SNG	GA-248		GAC-50
2013 - 2012	V6-3.6L	G-3744		GA-246		GAC-50

300

2020 - 2016	V8-5.7L	GP-406	GP-406 SNG	GA-446		
2020 - 2014	V6-3.6L	G-349		GA-446		
2015	V8-5.7L	GP-68	GP-68 SNG	GA-446		
2014 - 2012	V8-6.4L	GP-68	GP-68 SNG	GA-446		
2013 - 2012	V6-3.6L	G-3744		GA-446		
2013 - 2012	V8-5.7L	GP-68	GP-68 SNG	GA-446		
2010 - 2008	V8-5.7L	GP-68	GP-68 SNG	GA-289		
2010 - 2005	V6-2.7L	GP-406	GP-406 SNG	GA-289		
2010 - 2005	V6-3.5L	GP-68	GP-68 SNG	GA-289		
2009	V8-6.1L	GP-68	GP-68 SNG	GA-289		
2008	V8-6.1L	GP-81, GP-68	GP-81 SNG, GP-68 SNG	GA-289		
2007 - 2005	V8-5.7L	GP-81	GP-81 SNG	GA-289		
2007 - 2005	V8-6.1L	GP-81	GP-81 SNG	GA-289		

300M

2004 - 1998	V6-3.5L	GP-81	GP-81 SNG	GA-8606		
-------------	---------	-------	-----------	---------	--	--

ASPEN

2009-2008	V8-5.7L	GP-68	GP-68 SNG	GA-249		
2007	V8-4.7L	GP-81	GP-81 SNG	GA-249		
2007	V8-5.7L	GP-81	GP-81 SNG	GA-249		

CHRYSLER R/T





1997	L4-2.4L Turbo	GP-58	GP-58 SNG	GA-132		
------	---------------	-------	-----------	--------	--	--

CIRRUS

2010 - 2009	V6-3.5L	GP-406	GP-406 SNG	GA-248		
2010 - 2008	L4-2.4L	GP-406	GP-406 SNG	GA-248		
2008	V6-3.5L	GP-68	GP-68 SNG	GA-248		
2007	L4-2.4L	GP-406	GP-406 SNG	GA-183R		GAC-50
2007	V6-3.5L	GP-81	GP-81 SNG	GA-248		
2006 - 2001	L4-2.4L Turbo	GP-58	GP-58 SNG	GA-183R	GG-104	
2006 - 2001	V6-2.7L	GP-58	GP-58 SNG	GA-183R		
2000 - 1998	V6-2.5L	GP-81	GP-81 SNG	GA-132	GG-105	
2000	L4-2.4L	GP-58	GP-58 SNG	GA-183R	GG-105	
2000	L4-2.4L Turbo	GP-58	GP-58 SNG	GA-183R	GG-105	
1999	L4-2.4L Turbo	GP-58	GP-58 SNG	GA-132	GG-105	
1998	L4-2.4L Turbo	GP-58	GP-58 SNG	GA-132		
1997 - 1995	V6-2.5L	GP-81	GP-81 SNG	GA-132	GG-104	
1997	L4-2.4L	GP-58	GP-58 SNG	GA-132	GG-104	

(1) Nuevo

Los filtros Gonher prolongan la vida útil del motor evitando el desgaste prematuro.
Para vehículos anteriores a 1990, consulte nuestro catálogo web en www.grupogonher.com

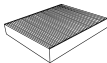
GONHER		ACEITE	SINTÉTICO	AIRE	COMB.	CABINA
AÑO	MOTOR					

FILTROS

CHRYSLER

CHRYSLER (Continúa)

CIRRUS (Continúa)

1997	L4-2.4L Turbo	GP-58	GP-58 SNG	GA-132	GG-104	
1996 - 1995	L4-2.4L	GP-406	GP-406 SNG	GA-248		

CONCORDE

2004-2002	V6-3.5L	GP-81	GP-81 SNG	GA-8606		
2001 - 1998	V6-3.2L	GP-81	GP-81 SNG	GA-141		
1997 - 1993	V6-3.5L	GP-81	GP-81 SNG	GA-141	GG-84	

CROSSFIRE

2007-2004	V6-3.2L	G-180		GA-2161		
-----------	---------	-------	--	---------	--	--

GRAND VOYAGER

2002-1996	V6-3.8L	GP-81	GP-81 SNG	GA-277		
2000	V6-3.3L	GP-81	GP-81 SNG	GA-271		
1995 - 1994	V6-3.8L	GP-81	GP-81 SNG	GA-271		
1993 - 1991	V6-3.3L	GP-81	GP-81 SNG	GA-271		

IMPERIAL

1991	V6-3.3L	GP-81	GP-81 SNG	GA-271	GG-7020	
------	---------	-------	-----------	--------	---------	--

INTREPID

1997 - 1994	V6-3.5L	GP-81	GP-81 SNG	GA-141	GG-84	
-------------	---------	-------	-----------	--------	-------	--

LEBARON

1995 - 1994	L4-2.5L Turbo	GP-81	GP-81 SNG	GA-277	GG-7018	
1993	L4-2.5L	GP-58	GP-58 SNG	GA-276	GG-7019	
1993	L4-2.5L Turbo	GP-58	GP-58 SNG	GA-276	GG-7019	
1992 - 1991	L4-2.5L Turbo	GP-81	GP-81 SNG	GA-276	GG-7020	

LHS

2001 - 1999	V6-3.5L	GP-81	GP-81 SNG	GA-141	GG-84	
1997 - 1994	V6-3.5L	GP-81	GP-81 SNG	GA-141	GG-84	

NEON

1997 - 1995	L4-2.0L	GP-58	GP-58 SNG	GA-277		
-------------	---------	-------	-----------	--------	--	--

NEW YORKER





1996 - 1994	V6-3.5L	GP-81	GP-81 SNG	GA-141	GG-84	
1994	V6-3.0L	GP-81	GP-81 SNG	GA-277		
1994	V6-3.5L Turbo	GP-81	GP-81 SNG	GA-141	GG-84	
1993 - 1992	V6-3.0L	GP-81	GP-81 SNG	GA-277	GG-7018	
1993 - 1990	L4-2.5L Turbo	GP-58	GP-58 SNG	GA-276	GG-7019	

PACIFICA

2021 - 2017	V6-3.6L			GA-2345, GA-2346		
2019 - 2017	V6-3.6L	G-349		GA-2345, GA-2346		
2008-2007	V6-4.0L	GP-81	GP-81 SNG	GA-510		GAC-2
2007	V6-3.8L	GP-81	GP-81 SNG	GA-510		GAC-2
2006-2004	V6-3.5L	GP-81	GP-81 SNG	GA-510		GAC-2
2005	V6-3.8L	GP-81	GP-81 SNG	GA-510		GAC-2

PHANTOM

1994	L4-2.5L Turbo	GP-81	GP-81 SNG	GA-277	GG-7020	
1993 - 1992	L4-2.2L Turbo	GP-58	GP-58 SNG	GA-277		
1993 - 1990	L4-2.5L Turbo	GP-58	GP-58 SNG	GA-277	GG-61	

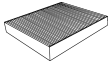
GONHER		ACEITE	SINTÉTICO	AIRE	COMB.	CABINA
AÑO	MOTOR					

CHRYSLER (Continúa)

PT CRUISER

2010 - 2006	L4-2.4L	GP-58	GP-58 SNG	GA-492		
2008 - 2006	L4-2.4L Turbo	GP-58	GP-58 SNG	GA-492		
2005 - 2003	L4-2.4L Turbo	GP-58	GP-58 SNG	GA-258		
2005 - 2001	L4-2.4L	GP-58	GP-58 SNG	GA-258		

SEBRING

2009 - 2007	L4-2.4L					GAC-50
2009 - 2007	V6-2.7L					GAC-50
2008 - 2007	V6-3.5L					GAC-50
2000	V6-2.5L			GA-132		
1999 - 1996	V6-2.5L			GA-132	GG-104	
1998 - 1996	L4-2.4L			GA-132	GG-104	
1995	V6-2.5L			GA-132		

SHADOW

1994 - 1993	L4-2.5L Turbo	GP-58	GP-58 SNG	GA-277		
1994 - 1990	L4-2.5L	GP-58	GP-58 SNG	GA-277		
1991 - 1990	L4-2.5L Turbo	GP-58	GP-58 SNG	GA-277		
1990	L4-2.2L	GP-58	GP-58 SNG	GA-271		

SPIRIT

1995 - 1991	L4-2.5L Turbo	GP-58	GP-58 SNG	GA-3814		
1995 - 1990	L4-2.5L	GP-58	GP-58 SNG	GA-3814		

STRATUS

1997 - 1996	L4-2.4L Turbo	GP-58	GP-58 SNG	GA-132		
1997 - 1995	L4-2.0L	GP-58	GP-58 SNG	GA-132		
1997 - 1995	L4-2.4L	GP-58	GP-58 SNG	GA-132		





TOWN & COUNTRY

2016 - 2014	V6-3.6L	G-349		GA-247		
2013	V6-3.6L	G-3744		GA-246		
2012 - 2011	V6-3.6L	G-3744		GA-247		
2010 - 2009	V6-4.0L	GP-58	GP-58 SNG	GA-248		
2010 - 2008	V6-3.3L	GP-58	GP-58 SNG	GA-248		
2010	V6-3.8L	GP-58	GP-58 SNG	GA-248		
2009	V6-3.8L	GP-81	GP-81 SNG	GA-277	GG-65	
2008	V6-3.8L	GP-81	GP-81 SNG	GA-277	GG-65	GAC-2
2008	V6-4.0L	GP-81	GP-81 SNG	GA-248		GAC-2
2007 - 2005	V6-3.8L	GP-81	GP-81 SNG	GA-248	GG-65	GAC-2
2007 - 2003	V6-3.3L	GP-58	GP-58 SNG	GA-248		GAC-2
2004 - 2001	V6-3.8L	GP-81	GP-81 SNG	GA-248	GG-265	GAC-2
2003 - 2001	V6-3.3L	GP-58	GP-58 SNG	GA-248		
2001	V6-3.3L	GP-58	GP-58 SNG	GA-248		GAC-2
2000 - 1996	V6-3.3L	GP-58	GP-58 SNG	GA-248	GG-267	
2000	V6-3.3L	GP-58	GP-58 SNG	GA-248	GG-267	GAC-2
2000	V6-3.8L	GP-81	GP-81 SNG	GA-277	GG-265	GAC-2
1999 - 1997	V6-3.8L	GP-81	GP-81 SNG	GA-277	GG-265	
1996 - 1994	V6-3.8L	GP-81	GP-81 SNG	GA-277	GG-65	
1993	V6-3.3L	GP-58	GP-58 SNG	GA-248		

VOYAGER

2021 - 2020	V6-3.6L			GA-2345		
2008	V6-3.3L	GP-58	GP-58 SNG	GA-248		GAC-2
2007 - 2001	V6-3.3L	GP-81	GP-81 SNG	GA-248	GG-265	GAC-2
2003 - 2001	L4-2.4L					GAC-2
2003 - 1999	V6-3.3L	GP-81	GP-81 SNG	GA-277	GG-265	
2003	V6-3.3L	GP-81	GP-81 SNG	GA-277	GG-265	GAC-2

Los filtros Gonher prolongan la vida útil del motor evitando el desgaste prematuro.
Para vehículos anteriores a 1990, consulte nuestro catálogo web en www.grupogonher.com

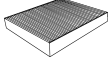
GONHER		ACEITE	SINTÉTICO	AIRE	COMB.	CABINA
AÑO	MOTOR					

CHRYSLER (Continúa)

VOYAGER (Continúa)

2001 - 2000	V6-3.3L	GP-81	GP-81 SNG	GA-277	GG-265	GAC-2
1998 - 1994	V6-3.3L	GP-81	GP-81 SNG	GA-277		

DODGE

ATOS

2012 - 2005	L4-1.1L	GP-91	GP-91 SNG	GA-302	GG-369	
2004 - 2001	L4-1.0L	GP-91	GP-91 SNG	GA-281	GG-169	

ATTITUDE

2020 - 2015	L3-1.2L	GP-149	GP-149 SNG	GA-1500		GAC-2276 ⁽¹⁾
2014 - 2006	L4-1.4L	GP-6811	GP-6811 SNG	GA-363		
2014 - 2006	L4-1.6L	GP-6811	GP-6811 SNG	GA-363		

AVENGER

2014 - 2008	L4-2.4L	GP-406	GP-406 SNG	GA-248		GAC-50
2010 - 2009	L4-2.0L	GP-406	GP-406 SNG	GA-248		
2009 - 2008	V6-2.7L	GP-2				GAC-50
2009 - 2008	V6-3.5L	GP-68	GP-68 SNG	GA-248		GAC-50
2008	L4-2.0L	GP-406	GP-406 SNG	GA-248		GAC-50
2000 - 1995	V6-2.5L	GP-81	GP-81 SNG	GA-7344		
1999 - 1995	L4-2.0L	GP-81	GP-81 SNG	GA-7344		

B150

1994 - 1993	V6-3.9L	GP-81	GP-81 SNG	GA-70	GG-249	
1994 - 1993	V8-5.2L	GP-81	GP-81 SNG	GA-70	GG-249	

B1500

1998 - 1995	V6-3.9L	GP-81	GP-81 SNG	GA-70		
1998 - 1995	V8-5.2L	GP-81	GP-81 SNG	GA-70		
1998	V8-5.9L	GP-81	GP-81 SNG	GA-70		

B250

1994 - 1993	V6-3.9L	GP-81	GP-81 SNG	GA-70	GG-249	
1994 - 1993	V8-5.2L	GP-81	GP-81 SNG	GA-70	GG-249	
1994 - 1993	V8-5.9L	GP-81	GP-81 SNG	GA-70	GG-249	

B2500

1998 - 1995	V8-5.2L	GP-81	GP-81 SNG	GA-70		
1998 - 1995	V8-5.9L	GP-81	GP-81 SNG	GA-70		
1997 - 1995	V6-3.9L	GP-81	GP-81 SNG	GA-70		

B350

1994 - 1993	V8-5.2L	GP-81	GP-81 SNG	GA-70	GG-249	
1994 - 1993	V8-5.9L	GP-81	GP-81 SNG	GA-70	GG-249	





B3500

1998 - 1995	V8-5.2L	GP-81	GP-81 SNG	GA-70		
1998 - 1995	V8-5.9L	GP-81	GP-81 SNG	GA-70		

CALIBER

2012	L4-2.4L	GP-406	GP-406 SNG	GA-220R		
2011	L4-2.4L	GP-406	GP-406 SNG	GA-220R		GAC-50
2010 - 2007	L4-2.4L	GP-406	GP-406 SNG	GA-489		GAC-50
2009 - 2008	L4-2.4L Turbo	GP-406	GP-406 SNG	GA-489		GAC-50
2009 - 2007	L4-1.8L	GP-406	GP-406 SNG	GA-489		GAC-50
2009 - 2007	L4-2.0L	GP-406	GP-406 SNG	GA-489		GAC-50

(1) Nuevo

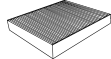
GONHER.		ACEITE	SINTÉTICO	AIRE	COMB.	CABINA
AÑO	MOTOR					

DODGE (Continúa)

CARAVAN

2007 - 2005	L4-2.4L	GP-58	GP-58 SNG	GA-248		GAC-2
2007 - 2005	V6-3.3L	GP-81	GP-81 SNG	GA-248		GAC-2
2005	V6-3.3L	GP-81	GP-81 SNG	GA-248		
2004 - 2001	V6-3.3L	GP-81	GP-81 SNG	GA-248	GG-265	GAC-2
2004	L4-2.4L	GP-81	GP-81 SNG	GA-248	GG-265	GAC-2
2003 - 2001	L4-2.4L	GP-58	GP-58 SNG	GA-248	GG-265	GAC-2
2000 - 1998	V6-3.3L				GG-267	
2000	L4-2.4L	GP-58	GP-58 SNG	GA-277	GG-265	GAC-2
2000	V6-3.0L	GP-81	GP-81 SNG	GA-277	GG-267	GAC-2
2000	V6-3.3L	GP-81	GP-81 SNG	GA-277	GG-267	GAC-2
1999 - 1996	L4-2.4L	GP-58	GP-58 SNG	GA-277	GG-265	
1999 - 1996	V6-3.0L	GP-81	GP-81 SNG	GA-277	GG-267	
1999 - 1996	V6-3.3L	GP-81	GP-81 SNG	GA-277	GG-267	
1998 - 1996	V6-3.8L	GP-81	GP-81 SNG	GA-277	GG-267	
1995 - 1993	V6-3.0L	GP-81	GP-81 SNG	GA-277	GG-65	
1995 - 1993	V6-3.3L	GP-81	GP-81 SNG	GA-271	GG-65	
1995	L4-2.5L	GP-58	GP-58 SNG	GA-271	GG-65	
1994 - 1993	L4-2.5L	GP-81	GP-81 SNG	GA-271	GG-65	

CHALLENGER

2020 - 2019	V8-5.7L	GP-68	GP-68 SNG	GA-446		
2020 - 2014	V6-3.6L	G-349		GA-446		
2020 - 2011	V8-6.4L	GP-68	GP-68 SNG	GA-446		
2020	V6-3.6L			GA-446		
2018 - 2015	V8-6.2L	GP-68	GP-68 SNG	GA-446		
2018 - 2013	V8-5.7L			GA-446		
2018 - 2011	V6-3.6L			GA-446		
2014 - 2013	V8-5.7L	GP-68	GP-68 SNG	GA-446		
2013	V6-3.6L	G-3744		GA-446		
2012 - 2011	V8-5.7L	GP-68	GP-68 SNG			
2010 - 2009	V8-5.7L	GP-68	GP-68 SNG	GA-289		
2009 - 2008	V8-6.1L	GP-68	GP-68 SNG	GA-289		
2009	V6-3.5L	GP-2		GA-289		





CHARGER

2020 - 2015	V8-6.2L	GP-68	GP-68 SNG	GA-446		
2020 - 2014	V6-3.6L	G-349		GA-446		
2020 - 2014	V8-5.7L	GP-68	GP-68 SNG	GA-446		
2020 - 2012	V8-6.4L	GP-68	GP-68 SNG	GA-446		
2013 - 2011	V6-3.6L	G-3744		GA-446		
2012 - 2011	V8-5.7L	GP-68	GP-68 SNG	GA-446		
2010 - 2008	V6-3.5L	GP-68	GP-68 SNG	GA-289		
2010 - 2008	V8-5.7L	GP-68	GP-68 SNG	GA-289		
2010 - 2008	V8-6.1L	GP-68	GP-68 SNG	GA-289		
2009	V6-2.7L	GP-406	GP-406 SNG	GA-289		
2008	V6-2.7L	GP-81, GP-68	GP-81 SNG, GP-68 SNG	GA-289		
2007 - 2006	V6-2.7L	GP-81	GP-81 SNG	GA-289		
2007 - 2006	V6-3.5L	GP-81	GP-81 SNG	GA-289		
2007 - 2006	V8-5.7L	GP-81	GP-81 SNG	GA-289		
2007 - 2006	V8-6.1L	GP-81	GP-81 SNG	GA-289		

D150

1993	V6-3.9L	GP-81	GP-81 SNG	GA-129	GG-72	
1993	V8-5.9L	GP-81	GP-81 SNG	GA-70		
1993	V8-5.9L	GP-81	GP-81 SNG	GA-70	GG-67	
1992 - 1991	V6-3.9L	GP-81	GP-81 SNG	GA-129	GG-67	

Los filtros Gonher prolongan la vida útil del motor evitando el desgaste prematuro.
Para vehículos anteriores a 1990, consulte nuestro catálogo web en www.grupogonher.com

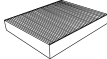
GONHER		ACEITE	SINTÉTICO	AIRE	COMB.	CABINA
AÑO	MOTOR					

DODGE (Continúa)

D150 (Continúa)

1990	L6-3.7L	GP-81	GP-81 SNG	GA-70		
------	---------	-------	-----------	-------	--	--

D250

1993 - 1990	V8-5.9L	GP-81	GP-81 SNG	GA-70	GG-67	
-------------	---------	-------	-----------	-------	-------	--

D350

1993	V8-5.9L	GP-81	GP-81 SNG	GA-70	GG-72	
1992 - 1990	V8-5.9L	GP-81	GP-81 SNG	GA-70	GG-67	

DAKOTA

2012	V6-3.7L	GP-405	GP-405 SNG	GA-490		
2011 - 2009	V6-3.7L	GP-405	GP-405 SNG	GA-283		
2008	V6-3.7L	GP-3600	GP-3600 SNG	GA-283		
2007 - 2004	V6-3.7L	GP-3600	GP-3600 SNG	GA-3901		
2007 - 2000	V8-4.7L	GP-81	GP-81 SNG	GA-3901		
2003 - 1998	V8-5.9L	GP-81	GP-81 SNG	GA-3901		
2003 - 1997	V6-3.9L	GP-81	GP-81 SNG	GA-3901		
2002 - 1993	L4-2.5L	GP-81	GP-81 SNG	GA-271	GG-72	
1999 - 1997	V8-5.2L	GP-81	GP-81 SNG	GA-3901		
1996 - 1993	V6-3.9L	GP-81	GP-81 SNG	GA-70	GG-72	
1996 - 1993	V8-5.2L	GP-81	GP-81 SNG	GA-70	GG-72	

DART

2016 - 2014	L4-2.4L	GP-406	GP-406 SNG	GA-7127		
2013	L4-2.0L	GP-406	GP-406 SNG	GA-7127		

DAYTONA

1993	L4-2.5L	GP-81	GP-81 SNG	GA-3814	GG-7020	
------	---------	-------	-----------	---------	---------	--





DURANGO

2020 - 2018	V8-6.4L					GAC-2282 ⁽¹⁾
2020 - 2014	V6-3.6L	G-349		GA-478		GAC-2282 ⁽¹⁾
2020	V8-5.7L					GAC-2282 ⁽¹⁾
2019 - 2018	V8-5.7L	GP-406	GP-406 SNG			GAC-2282 ⁽¹⁾
2017 - 2016	V8-5.7L	GP-406	GP-406 SNG	GA-478		GAC-2282 ⁽¹⁾
2015 - 2012	V8-5.7L	GP-68	GP-68 SNG	GA-478		GAC-2282 ⁽¹⁾
2013	V6-3.6L	G-3744		GA-246		GAC-2282 ⁽¹⁾
2012	V6-3.6L	G-3744		GA-478		GAC-2282 ⁽¹⁾
2009 - 2007	V8-5.7L	GP-68	GP-68 SNG	GA-249		
2009	V6-3.7L	GP-405	GP-405 SNG	GA-249		
2009	V8-4.7L	GP-81	GP-81 SNG	GA-249		
2009	V8-5.7L Híbrido	GP-68	GP-68 SNG	GA-249		
2007 - 2004	V6-3.7L	GP-3600	GP-3600 SNG	GA-249		
2007 - 2004	V8-4.7L	GP-81	GP-81 SNG	GA-249		
2006 - 2004	V8-5.7L	GP-81	GP-81 SNG	GA-249		
2003 - 1998	V8-5.9L	GP-81	GP-81 SNG	GA-3901	GG-111	
2003	V8-4.7L	GP-81	GP-81 SNG	GA-3901		
2002 - 2001	V8-4.7L	GP-81	GP-81 SNG	GA-3901	GG-111	
2000 - 1998	V8-5.2L	GP-81	GP-81 SNG	GA-3901	GG-111	
2000	V8-4.7L	GP-81	GP-81 SNG	GA-249		

DYNASTY

1993	L4-2.5L	GP-81	GP-81 SNG	GA-3814	GG-7020	
------	---------	-------	-----------	---------	---------	--

(1) Nuevo

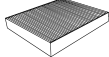
GONHER		ACEITE	SINTÉTICO	AIRE	COMB.	CABINA
AÑO	MOTOR					

DODGE (Continúa)

GRAND CARAVAN

2019 - 2017	V6-3.6L	G-349		GA-247		
2009-2008	V6-3.3L	GP-81	GP-81 SNG			
2008 - 2001	V6-3.8L					GAC-2
2008	V6-4.0L					GAC-2
2007-2005	V6-3.3L	GP-81	GP-81 SNG	GA-248		
2007 - 2001	V6-3.3L	GP-81	GP-81 SNG	GA-248		GAC-2
2003 - 2001	V6-3.3L	GP-81	GP-81 SNG	GA-248		
2000 - 1996	V6-3.0L			GA-277	GG-267	
2000	V6-3.3L	GP-81	GP-81 SNG	GA-248	GG-267	
2000	V6-3.3L	GP-81	GP-81 SNG	GA-248	GG-267	GAC-2
2000	V6-3.8L				GG-267	GAC-2
1999 - 1996	V6-3.3L	GP-81	GP-81 SNG	GA-277	GG-267	
1999 - 1996	V6-3.8L				GG-267	
1997	L4-2.4L	GP-58	GP-58 SNG	GA-277		
1996	L4-2.4L	GP-58	GP-58 SNG	GA-277	GG-267	
1995 - 1993	V6-3.0L			GA-277		
1995 - 1993	V6-3.3L	GP-81	GP-81 SNG	GA-271		

H100

2013 - 2012	L4-2.4L	GP-6811	GP-6811 SNG	GA-362		
2013 - 2006	L4-2.5L Turbo diésel	GP-112		GA-110	GPP-111	
2005-2003	L4-2.4L	GP-6811	GP-6811 SNG	GA-362	GG-237	

H100 VAN

2013 - 2011	L4-2.5L Diésel	GP-112		GA-115	GPP-111	
-------------	----------------	--------	--	--------	---------	--

I10

2014 - 2012	L4-1.1L	GP-149	GP-149 SNG	GA-366		GAC-2277 ⁽¹⁾
-------------	---------	--------	------------	--------	--	-------------------------

INTREPID

2004-2000	V6-3.5L	GP-81	GP-81 SNG	GA-8606		
2004 - 1998	V6-2.7L	GP-81	GP-81 SNG	GA-8606		
2000 - 1998	V6-3.2L	GP-81	GP-81 SNG	GA-8606		
1997 - 1993	V6-3.5L	GP-81	GP-81 SNG	GA-8606		
1994	V6-3.3L	GP-81	GP-81 SNG	GA-141	GG-84	

JOURNEY

2020	L4-2.4L					GAC-50
2019 - 2014	V6-3.6L	G-349		GA-246		GAC-50
2019 - 2009	L4-2.4L	GP-406	GP-406 SNG	GA-248		GAC-50
2013 - 2011	V6-3.6L	G-3744		GA-246		GAC-50
2010 - 2009	V6-3.5L	GP-406	GP-406 SNG	GA-248		GAC-50





NEON

2018 - 2017	L4-1.4L	G-446				
2018 - 2017	L4-1.6L	G-446				
2005-2003	L4-2.4L Turbo	GP-3600	GP-3600 SNG	GA-278R		
2005-2000	L4-2.0L	GP-58	GP-58 SNG	GA-278R	GG-195	
2005 - 1998	L4-2.0L	GP-58	GP-58 SNG	GA-277	GG-195	
1997 - 1995	L4-2.0L	GP-58	GP-58 SNG	GA-277	GG-95	

NITRO

2012 - 2009	V6-3.7L	GP-405	GP-405 SNG	GA-143		
2010 - 2009	V6-4.0L	GP-406	GP-406 SNG	GA-143		
2009 - 2007	V6-4.0L	GP-81	GP-81 SNG	GA-143		
2008 - 2007	V6-3.7L	GP-3600	GP-3600 SNG	GA-143		

(1) Nuevo

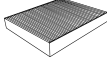
GONHER		ACEITE	SINTÉTICO	AIRE	COMB.	CABINA
AÑO	MOTOR					

DODGE (Continúa)

RAM 1500

2010 - 2009	V6-3.7L	GP-405	GP-405 SNG	GA-490		
2009-2002	V8-4.7L	GP-81	GP-81 SNG	GA-490		
2009	V8-4.7L	GP-68	GP-68 SNG	GA-490		
2009	V8-5.7L	GP-81	GP-81 SNG	GA-490	GG-111	
2008-2002	V6-3.7L	GP-3600	GP-3600 SNG	GA-490		
2008	V8-5.7L	GP-68	GP-68 SNG	GA-490	GG-111	
2007-2003	V8-5.7L	GP-81	GP-81 SNG	GA-490	GG-111	
2006-2004	V10 8.3L	GP-81	GP-81 SNG	GA-488		
2003-1994	V8-5.9L	GP-81	GP-81 SNG	GA-3901	GG-111	
2002-1997	V6-3.9L	GP-81	GP-81 SNG	GA-3901		
2001-1994	V8-5.2L	GP-81	GP-81 SNG	GA-3901	GG-111	
1996-1994	V6-3.9L	GP-81	GP-81 SNG	GA-3901	GG-111	

RAM 1500 VAN

2003-1999	V6-3.9L	GP-81	GP-81 SNG	GA-70		
2003-1999	V8-5.9L	GP-81	GP-81 SNG	GA-70		
2003	V8-5.2L	GP-81	GP-81 SNG	GA-70		
2002-1999	V8-5.2L	GP-81	GP-81 SNG	GA-70	GG-111	
1998	V8-5.2L	GP-81	GP-81 SNG	GA-70		
1997	V6-3.9L	GP-81	GP-81 SNG	GA-70		
1996-1995	V8-5.2L	GP-81	GP-81 SNG	GA-70		

RAM 2500





2010-2006	L6-5.9L Turbo diésel	GP-178		GA-488	GS-1261	
2009-2008	V8-5.7L	GP-68	GP-68 SNG	GA-490	GG-111	
2009-2007	L6-6.7L Turbo diésel	GP-178		GA-252		
2009-2004	V8-4.7L	GP-81	GP-81 SNG	GA-490		
2007-2003	V8-5.7L	GP-81	GP-81 SNG	GA-490	GG-111	
2005-1994	L6-5.9L Turbo diésel	GP-178		GA-240		
2003-2002	V8-4.7L	GP-81	GP-81 SNG	GA-3901		
2003	V10 8.0L	GP-81	GP-81 SNG	GA-490		
2003	V10 8.0L	GP-81	GP-81 SNG	GA-490	GG-111	
2002-1994	V10 8.0L	GP-81	GP-81 SNG	GA-2198	GG-111	
2002-1994	V8-5.9L	GP-81	GP-81 SNG	GA-3901	GG-111	
2001-1997	V8-5.2L	GP-81	GP-81 SNG	GA-3901		
1996-1994	V8-5.2L	GP-81	GP-81 SNG			

RAM 2500 VAN

2003-1999	V8-5.9L	GP-81	GP-81 SNG	GA-70		
2003	V8-5.2L	GP-81	GP-81 SNG	GA-70		
2002-1999	V8-5.2L	GP-81	GP-81 SNG	GA-70	GG-111	
1998-1996	V8-5.2L	GP-81	GP-81 SNG	GA-70		

RAM 3500

2009-2007	L6-6.7L Turbo diésel	GP-178		GA-252		
2009	V8-5.7L	GP-68	GP-68 SNG	GA-490		
2007-2003	L6-5.9L Turbo diésel	GP-178		GA-488	GS-1261	
2007-2003	V8-5.7L	GP-81	GP-81 SNG	GA-490	GG-111	
2003	V10 8.0L	GP-81	GP-81 SNG	GA-490		
2002-2000	L6-5.9L Turbo diésel	GP-178		GA-240	GS-1261	
2002-1994	V10 8.0L	GP-81	GP-81 SNG	GA-2198	GG-111	
2002	V8-5.9L	GP-81	GP-81 SNG	GA-490	GG-111	
2001-1994	V8-5.9L	GP-81	GP-81 SNG	GA-3901	GG-111	
1999-1994	L6-5.9L Turbo diésel	GP-178		GA-240		

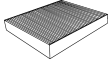
GONHER.		ACEITE	SINTÉTICO	AIRE	COMB.	CABINA
AÑO	MOTOR					

DODGE (Continúa)

RAM 3500 VAN

2003 - 2001	V8-5.2L	GP-81	GP-81 SNG	GA-70	GG-111	
2003 - 1997	V8-5.9L	GP-81	GP-81 SNG	GA-70		
2003	V8-5.2L	GP-81	GP-81 SNG	GA-70		
2001 - 2000	V8-5.2L	GP-81	GP-81 SNG	GA-70		
1999	V8-5.2L	GP-81	GP-81 SNG	GA-70	GG-111	
1996	V8-5.2L	GP-81	GP-81 SNG	GA-70		

RAM 50

1993 - 1990	L4-2.4L			GA-7142	GG-151	
1991 - 1990	V6-3.0L			GA-7142		

RAMCHARGER

2001 - 1999	V8-5.2L	GP-81	GP-81 SNG	GA-3901		
2001 - 1999	V8-5.9L	GP-81	GP-81 SNG	GA-3901		
1996 - 1994	V8-5.9L	GP-81	GP-81 SNG	GA-3901		
1993 - 1992	V8-5.9L	GP-81	GP-81 SNG	GA-70	GG-72	
1993	V8-5.2L	GP-81	GP-81 SNG	GA-3901	GG-72	
1991 - 1990	V8-5.9L	GP-81	GP-81 SNG	GA-70	GG-67	

SPIRIT

1995	L4-2.5L	GP-81	GP-81 SNG	GA-3814	GG-7020	
1994 - 1993	L4-2.5L	GP-81	GP-81 SNG	GA-3814, GA-277	GG-7020	

STRATUS

2006-2005	L4-2.4L	GP-58	GP-58 SNG	GA-7344	GG-105	
2006-2005	L4-2.4L Turbo	GP-58	GP-58 SNG	GA-7344	GG-105	
2006-2001	L4-2.0L	GP-58	GP-58 SNG	GA-132	GG-104	
2005	V6-3.0L	GP-149	GP-149 SNG	GA-7344	GG-104	
2004-2001	L4-2.4L	GP-58	GP-58 SNG	GA-183R	GG-105	
2004-2001	L4-2.4L Turbo	GP-58	GP-58 SNG	GA-183R	GG-105	
2003	V6-2.7L	GP-81	GP-81 SNG	GA-183R		
2003	V6-3.0L	GP-149	GP-149 SNG	GA-7344	GG-104	
2000-1998	L4-2.4L Turbo	GP-58	GP-58 SNG	GA-132	GG-105	
2000-1995	L4-2.0L	GP-58	GP-58 SNG	GA-132	GG-105	
2000-1995	L4-2.4L	GP-58	GP-58 SNG	GA-132	GG-105	

VAN 1000

2009-2008	L4-2.4L	GP-6811	GP-6811 SNG	GA-1478	GG-187	
-----------	---------	---------	-------------	---------	--------	--

VERNA

2006-2004	L4-1.5L	GP-6811	GP-6811 SNG	GA-216	GG-182	
2006-2004	L4-1.6L	GP-6811	GP-6811 SNG	GA-216	GG-182	

VIPER





2015	V10 8.4L	GP-68	GP-68 SNG			
2010 - 2009	V10 8.4L	GP-68	GP-68 SNG			
2006 - 2003	V10 8.3L	GP-81	GP-81 SNG			
2002 - 1992	V10 8.0L	GP-81	GP-81 SNG		GG-249	





VISION

2018	L4-1.6L	G-446		GA-6826		
2017	L4-1.6L	GP-149	GP-149 SNG	GA-6826		
2016 - 2015	L4-1.6L	GP-6811	GP-6811 SNG	GA-6826		

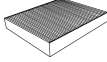
W150

1993	V8-5.9L	GP-81	GP-81 SNG	GA-70	GG-72	
1993	V8-5.9L	GP-81	GP-81 SNG	GA-70	GG-8 L	

GONHER		ACEITE	SINTÉTICO	AIRE	COMB.	CABINA
AÑO	MOTOR					
DODGE (Continúa)						
W250						
1993	V8-5.9L	GP-81	GP-81 SNG	GA-70	GG-67	
1993	V8-5.9L	GP-81	GP-81 SNG	GA-70	GG-72	
1990	V8-5.9L	GP-81	GP-81 SNG	GA-70	GG-67	
W350						
1993	L6-5.9L Turbo diésel	GP-178			GP-1232	
FERRARI						
348 SPIDER						
1995	V8-3.4L			GA-476		
456 GT						
1995	V12 5.5L			GA-476		
512 M						
1995	H12 4.9L			GA-476		
550 MARANELLO						
2002-1999	V12 5.5L				GG-408	
F355 BERLINETTA						
1995	V8-3.5L			GA-476		
F50						
1995	V12 4.7L			GA-476		
FIAT						
500						
2019	L4-1.4L Turbo			GA-3648		
2017 - 2012	L4-1.4L	G-713		GA-3648		
2017 - 2012	L4-1.4L Turbo	G-713		GA-3648		
2011 - 2009	L4-1.4L	GP-149	GP-149 SNG			
500L						
2018 - 2015	L4-1.4L Turbo	G-713				
500X						
2018 - 2016	L4-2.4L	GP-406	GP-406 SNG			
DUCATO						
2019 - 2017	L4-2.3L Turbo diésel			GA-2220R		
2016 - 2011	L4-2.3L Turbo diésel	GP-109		GA-2220R		
2012 - 2011	L4-3.0L Turbo diésel	GP-109		GA-2220R	G-723	
2009	L4-2.3L Turbo diésel	GP-109		GA-2220R		
2009	L4-3.0L Turbo diésel	GP-109		GA-2220R	G-723	
2008	L4-2.3L Turbo diésel	GP-109				
2008	L4-3.0L Turbo diésel	GP-109			G-723	
IDEA						
2009-2008	L4-1.8L	GP-46		GA-5627	GG-64	
LINEA						
2011	L4-1.4L Turbo	G-713				
MOBI						
2020 - 2019	L4-1.0L	GP-149	GP-149 SNG	GA-2215		
2018 - 2017	L4-1.0L	GP-149	GP-149 SNG	GA-2215	GG-291	

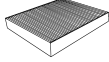
GONHER		ACEITE	SINTÉTICO	AIRE	COMB.	CABINA
AÑO	MOTOR					
FIAT (Continúa)						

PALIO

2017	L4-1.6L			GA-6826		
2016	L4-1.6L	G-446		GA-6826		
2015 - 2013	L4-1.6L	G-446				
2008	L4-1.8L	GP-46		GA-5627		
2007	L4-1.8L	GP-46		GA-5627	GG-64	
2006	L4-1.8L	GP-46		GA-5627		
2005	L4-1.6L	GP-24		GA-5627		
2005	L4-1.8L	GP-24		GA-5627		
2004	L4-1.6L	GP-24		GA-5627	GG-64	

PANDA

2012 - 2011	L4-1.2L	GP-149	GP-149 SNG			
2009-2007	L4-1.2L	GP-291				

STILO

2007	L5-2.4L	GP-24				
------	---------	-------	--	--	--	--

STRADA

2014 - 2012	L4-1.6L			GA-5627		
2011 - 2009	L4-1.8L			GA-5627		
2008-2007	L4-1.8L	GP-46		GA-5627	GG-64	

UNO

2020 - 2013	L4-1.4L	GP-149	GP-149 SNG	GA-2215		
-------------	---------	--------	------------	---------	--	--

FORD

AEROSTAR

1997 - 1993	V6-4.0L	GP-1		GA-273	GG-47	
1997 - 1991	V6-3.0L	GP-3600	GP-3600 SNG	GA-273	GG-47	
1994	V6-3.0L	GP-1, GP-3600	GP-3600 SNG	GA-273	GG-47	
1993	V6-4.0L	GP-1, GP-3600	GP-3600 SNG	GA-273	GG-47	
1993	V6-4.0L	GP-1		GA-273	GG-47	

ASPIRE

1997 - 1995	L4-1.3L	GP-91	GP-91 SNG			
1994	L4-1.3L	GP-149	GP-149 SNG	GA-176		





B-200

1991 - 1990	V8-5.0L	GP-1		GA-74	GG-25	
-------------	---------	------	--	-------	-------	--

BRONCO

1996 - 1995	V8-5.0L	GP-1		GA-174, GA-186	GG-1872	
1996 - 1995	V8-5.8L	GP-1		GA-174, GA-186	GG-1872	
1994 - 1993	V8-5.0L	GP-1		GA-174, GA-176	GG-1872	
1994 - 1993	V8-5.8L	GP-1		GA-174, GA-176	GG-1872	
1992 - 1990	V8-5.0L			GA-176		
1992 - 1990	V8-5.8L			GA-176		
1992	L6-4.9L	GP-1		GA-174, GA-176	GG-1872	
1991 - 1990	L6-4.9L	GP-1		GA-174, GA-176	GG-47	

Los filtros Gonher prolongan la vida útil del motor evitando el desgaste prematuro.
Para vehículos anteriores a 1990, consulte nuestro catálogo web en www.grupogonher.com

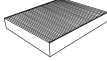
GONHER		ACEITE	SINTÉTICO	AIRE	COMB.	CABINA
AÑO	MOTOR					

FORD (Continúa)

CLUB WAGON

1998	V8-5.4L	GP-1		GA-1615	GG-1872	
1997	V8-5.4L	GP-68	GP-68 SNG	GA-1615	GG-1872	
1996 - 1995	V8-5.8L	GP-1		GA-174	GG-1872	
1995	L6-4.9L	GP-1		GA-1615	GG-1872	

C-MAX

2018 - 2013	L4-2.0L Híbrido	GP-58	GP-58 SNG			
-------------	-----------------	-------	-----------	--	--	--

CONTOUR

2000 - 1998	L4-2.0L	GP-128		GA-127	GG-47	
2000 - 1998	L4-2.0L	GP-128		GA-127	GG-47	GAC-9
2000 - 1995	V6-2.5L	GP-68	GP-68 SNG	GA-128	GG-47	GAC-9
1997 - 1996	L4-2.0L	GP-9		GA-127	GG-47	
1997 - 1995	L4-2.0L	GP-9		GA-127	GG-47	GAC-9

COUGAR

1994 - 1992	V6-3.8L	GP-3600	GP-3600 SNG	GA-275		
1991 - 1990	V6-3.8L	GP-9		GA-275		

COURIER

2012 - 2011	L4-1.6L	GP-3600	GP-3600 SNG	GA-179		
2010 - 2008	L4-1.6L	GP-3600	GP-3600 SNG	GA-179	GG-1872	
2007 - 2001	L4-1.6L	GP-3600	GP-3600 SNG	GA-179	GG-1872	GAC-1

CROWN VICTORIA

2011 - 2009	V8-4.6L	GP-58	GP-58 SNG	GA-5056	GG-986	
2009 - 1993	V8-4.6L	GP-68	GP-68 SNG	GA-5056	GG-986	

E-150





2009 - 2003	V8-4.6L	GP-68	GP-68 SNG	GA-1615	GG-986	
2008	V8-5.4L	GP-68	GP-68 SNG	GA-1615		
2007 - 2003	V8-5.4L	GP-68	GP-68 SNG	GA-1615	GG-986	
2003	V6-4.2L	GP-3600	GP-3600 SNG	GA-1615	GG-986	
2002	V6-4.2L	GP-3600	GP-3600 SNG	GA-1615		
2002	V8-5.4L	GP-68	GP-68 SNG	GA-1615		

E-150 CLUB WAGON

2005 - 2003	V8-4.6L	GP-3600	GP-3600 SNG	GA-1615	GG-986	
2005 - 2003	V8-5.4L	GP-3600	GP-3600 SNG	GA-1615	GG-986	
2003	V6-4.2L	GP-3600	GP-3600 SNG	GA-1615	GG-986	

E-150 ECONOLINE

2008 - 2007	V8-5.4L	GP-68	GP-68 SNG	GA-1615		
2002 - 2000	V8-5.4L	GP-68	GP-68 SNG	GA-1615	GG-1872	
2002 - 1997	V6-4.2L	GP-3600	GP-3600 SNG	GA-1615	GG-986	
2002 - 1997	V8-4.6L	GP-68	GP-68 SNG	GA-1615	GG-1872	
1999 - 1997	V8-5.4L	GP-68	GP-68 SNG	GA-1615	GG-1872	GAC-1
1996 - 1993	L6-4.9L	GP-1		GA-174	GG-1872	
1996 - 1993	V8-5.0L	GP-1		GA-174	GG-1872	
1996 - 1993	V8-5.8L	GP-1		GA-174	GG-1872	

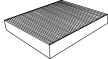
GONHER		ACEITE	SINTÉTICO	AIRE	COMB.	CABINA
AÑO	MOTOR					

FORD (Continúa)

E-150 ECONOLINE CLUB WAGON

2002 - 2000	V8-5.4L	GP-68	GP-68 SNG	GA-1615	GG-1872	
2002 - 1997	V6-4.2L	GP-3600	GP-3600 SNG	GA-1615	GG-1872	
2002 - 1997	V8-4.6L	GP-68	GP-68 SNG	GA-1615	GG-1872	
1999 - 1997	V8-5.4L	GP-68	GP-68 SNG	GA-1615	GG-1872	GAC-1
1996 - 1993	V8-5.0L	GP-1		GA-174	GG-1872	
1996 - 1993	V8-5.8L	GP-1		GA-174	GG-1872	
1996	L6-4.9L	GP-1		GA-174	GG-1872	
1995	L6-4.9L	GP-1		GA-174, GA-186	GG-1872	
1994 - 1993	L6-4.9L	GP-1		GA-174	GG-1872	

E-250

2008 - 2003	V8-4.6L	GP-68	GP-68 SNG	GA-1615	GG-986	
2008 - 2003	V8-5.4L	GP-68	GP-68 SNG	GA-1615	GG-986	
2003	V6-4.2L	GP-3600	GP-3600 SNG	GA-1615	GG-986	

E-250 ECONOLINE

2002 - 2000	V8-5.4L	GP-68	GP-68 SNG	GA-1615	GG-1872	
2002 - 1997	V6-4.2L	GP-3600	GP-3600 SNG	GA-1615	GG-1872	
1999 - 1997	V8-5.4L	GP-68	GP-68 SNG	GA-1615	GG-1872	GAC-1
1998	V8-5.4L	GP-68	GP-68 SNG	GA-1615	GG-1872	
1996 - 1993	L6-4.9L	GP-1		GA-174	GG-1872	
1996 - 1993	V8-5.8L	GP-1		GA-174	GG-1872	

E-350 CLUB WAGON





2005 - 2003	V8-5.4L	GP-68	GP-68 SNG	GA-1615	GG-986	
2005	V8-6.0L Turbo diésel	G-3752		GA-1804		
2004	V8-7.3L Turbo diésel	GP-562		GA-394		
2003	V8-7.3L Turbo diésel	GP-562		GA-394	G-862T	
2002	V8-5.4L	GP-68	GP-68 SNG	GA-1615		

E-350 ECONOLINE

2008 - 2007	V8-5.4L	GP-68	GP-68 SNG	GA-1615	GG-986	
2000	V8-5.4L	GP-68	GP-68 SNG	GA-1615	GG-1872	
1999 - 1997	V8-5.4L	GP-68	GP-68 SNG	GA-1615	GG-1872	GAC-1
1998 - 1997	V10 6.8L	GP-68	GP-68 SNG	GA-1615	GG-1872	
1998 - 1997	V8-5.4L	GP-68	GP-68 SNG	GA-1615	GG-1872	
1998 - 1995	V8-7.3L Turbo diésel	GP-562		GA-394		
1996 - 1993	L6-4.9L	GP-1		GA-174	GG-1872	
1996 - 1993	V8-5.8L	GP-1		GA-174	GG-1872	
1996 - 1993	V8-7.5L	GP-1		GA-174	GG-1872	
1996	V8-5.8L	GP-1, GP-68	GP-68 SNG	GA-174, GA-186	GG-1872	

E-350 ECONOLINE CLUB WAGON

1998 - 1997	V10 6.8L	GP-68	GP-68 SNG	GA-1615	GG-1872	
1998 - 1997	V8-5.4L	GP-68	GP-68 SNG	GA-1615	GG-1872	GAC-1
1998 - 1995	V8-7.3L Turbo diésel	GP-562		GA-394		
1997	V8-5.4L	GP-68	GP-68 SNG	GA-1615	GG-1872	
1996 - 1993	L6-4.9L	GP-1		GA-174	GG-1872	
1996 - 1993	V8-5.8L	GP-1		GA-174	GG-1872	
1996 - 1993	V8-7.5L	GP-1		GA-174	GG-1872	

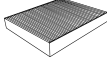
GONHER		ACEITE	SINTÉTICO	AIRE	COMB.	CABINA
AÑO	MOTOR					

FORD (Continúa)

E-350 SUPER DUTY

2009 - 2004	V8-6.0L Turbo diésel	G-3752		GA-1804		
2009 - 2000	V8-5.4L	GP-68	GP-68 SNG	GA-1615	GG-986	
2009	V10 6.8L	GP-68	GP-68 SNG	GA-1615	GG-1872	
2007 - 1999	V10 6.8L	GP-68	GP-68 SNG	GA-1615	GG-1872	
2003 - 2000	V8-7.3L Turbo diésel	GP-562		GA-394		
2002	V10 6.8L	GP-68	GP-68 SNG			
2001	V8-5.4L	GP-68	GP-68 SNG	GA-1615	GG-1872	
2000	V8-5.4L			GA-1615	GG-1872	
1999	V8-5.4L	GP-68	GP-68 SNG	GA-1615	GG-1872	
1999	V8-5.4L	GP-68	GP-68 SNG	GA-1615	GG-986	GAC-1
1999	V8-7.3L Turbo diésel	GP-562		GA-394		GAC-1

ECONOLINE

2006 - 2004	V8-4.6L	GP-68	GP-68 SNG	GA-1615		
2006 - 1999	V8-5.4L	GP-68	GP-68 SNG	GA-1615		
2003	V6-4.2L	GP-1		GA-1615		
2001 - 1999	V6-4.2L	GP-1		GA-1615		

ECONOLINE VAN

2014 - 2010	V8-4.6L	GP-68	GP-68 SNG	GA-1615		
-------------	---------	-------	-----------	---------	--	--

ECONOLINE WAGON

2014 - 2010	V8-4.6L	GP-68	GP-68 SNG	GA-1615		
2014 - 2010	V8-5.4L	GP-68	GP-68 SNG	GA-1615		

ECOSPORT

2019 - 2018	L3-1.5L	GP-503		GA-226R, GA-2229		
2019 - 2018	L4-2.0L	GP-503		GA-226R, GA-2229		
2017	L4-2.0L	GP-58	GP-58 SNG	GA-2229		
2016	L4-2.0L	GP-58	GP-58 SNG	GA-1596, GA-2229		
2015 - 2012	L4-2.0L	GP-58	GP-58 SNG	GA-1596, GA-2229	GG-986	
2011 - 2010	L4-2.0L	GP-58	GP-58 SNG	GA-1596	GG-986	
2009 - 2004	L4-2.0L	GP-58	GP-58 SNG	GA-288R	GG-986	





EDGE

2020 - 2019	V6-2.7L Turbo	GP-58	GP-58 SNG	GA-1573	GG-101	
2020 - 2017	L4-2.0L Turbo	GP-58	GP-58 SNG	GA-1573	GG-101	
2018	V6-2.7L Turbo			GA-1573	GG-101	
2017	V6-2.7L Turbo			GA-1573		
2016	V6-2.7L Turbo			GA-1573	GG-101	
2015	V6-3.5L	GP-405	GP-405 SNG	GA-1573	GG-101	
2014 - 2010	V6-3.5L	GP-405	GP-405 SNG	GA-1542		
2009 - 2007	V6-3.5L	GP-3600	GP-3600 SNG	GA-1542		

ESCAPE

2020	L4-2.0L Turbo	GP-58	GP-58 SNG			
2019 - 2014	L4-2.0L Turbo	GP-58	GP-58 SNG	GA-226R		
2019 - 2013	L4-2.5L	GP-58	GP-58 SNG	GA-225		
2012 - 2009	V6-3.0L	GP-405	GP-405 SNG	GA-222R	GG-1872	
2012	L4-2.5L	GP-58	GP-58 SNG	GA-224	GG-1872	
2011	L4-2.5L	GP-58	GP-58 SNG	GA-224		
2009	L4-2.5L	GP-58	GP-58 SNG	GA-224		
2009	L4-2.5L Híbrido	GP-58	GP-58 SNG			

Los filtros Gonher prolongan la vida útil del motor evitando el desgaste prematuro.
Para vehículos anteriores a 1990, consulte nuestro catálogo web en www.grupogonher.com

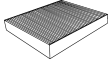
GONHER.		ACEITE	SINTÉTICO	AIRE	COMB.	CABINA
AÑO	MOTOR					

FORD (Continúa)

ESCAPE (Continúa)

2008 - 2006	L4-2.3L	GP-58, G-70	GP-58 SNG	GA-224	GG-47	
2008 - 2005	L4-2.3L Híbrido	G-70				
2008 - 2001	V6-3.0L	GP-68	GP-68 SNG	GA-224	GG-47	
2005	L4-2.3L	GP-58	GP-58 SNG	GA-224	GG-47	
2004 - 2001	L4-2.0L	GP-128		GA-224	GG-47	

ESCORT

2003	L4-2.0L	GP-128		GA-130	GG-30	
2002 - 2000	L4-2.0L	GP-128		GA-130	GG-30	GAC-7
1999 - 1997	L4-2.0L	GP-128		GA-130	GG-30	
1996 - 1993	L4-1.8L	GP-91	GP-91 SNG	GA-133	GG-47	
1996 - 1993	L4-1.9L	GP-3600	GP-3600 SNG	GA-277	GG-47	

EXCURSION

2005 - 2003	V8-6.0L Turbo diésel	G-3752		GA-4999		
2005 - 2000	V10 6.8L	GP-68	GP-68 SNG	GA-1615	GG-1872	
2003 - 2002	V8-7.3L Turbo diésel	GP-562				
2001 - 2000	V8-7.3L Turbo diésel	GP-562		GA-780		

EXPEDITION

2020 - 2015	V6-3.5L Turbo	GP-405	GP-405 SNG	GA-437	GG-308	
2014 - 2013	V8-5.4L	GP-68	GP-68 SNG	GA-437	GG-308	
2012 - 2011	V8-5.4L	GP-68	GP-68 SNG	GA-437		
2010 - 2007	V8-5.4L	GP-68	GP-68 SNG	GA-437	GG-308	
2009	V8-5.4L	GP-68	GP-68 SNG	GA-437	GG-986	
2006	V8-5.4L	GP-68	GP-68 SNG	GA-1615	GG-986	
2005 - 1997	V8-5.4L	GP-68	GP-68 SNG	GA-1615	GG-986	GAC-1
2004 - 2001	V8-4.6L	GP-68	GP-68 SNG	GA-1615	GG-1872	GAC-1
2000	V8-4.6L	GP-68	GP-68 SNG		GG-986	GAC-1
1999 - 1997	V8-4.6L	GP-68	GP-68 SNG	GA-1615	GG-1872	GAC-1





EXPLORER

2019 - 2017	V6-3.5L Turbo	GP-405	GP-405 SNG	GA-1542		
2019 - 2011	V6-3.5L	GP-405	GP-405 SNG	GA-1542		
2015	V6-3.5L Turbo	GP-405	GP-405 SNG	GA-1542		
2010 - 2006	V8-4.6L	GP-68	GP-68 SNG	GA-1540	GG-101	
2010 - 2004	V6-4.0L	GP-68	GP-68 SNG	GA-395	GG-101	
2009 - 2003	V6-4.0L	GP-68	GP-68 SNG	GA-273	GG-1872	
2005	V8-4.6L	GP-68	GP-68 SNG	GA-395	GG-101	
2004	V8-4.6L	GP-68	GP-68 SNG	GA-395	GG-1872	
2003	V6-4.0L	GP-68	GP-68 SNG	GA-395	GG-308	
2003	V8-4.6L	GP-68	GP-68 SNG	GA-395	GG-101	
2002 - 2001	V6-4.0L	GP-68	GP-68 SNG	GA-1615	GG-1872	
2002	V6-4.0L	GP-68	GP-68 SNG	GA-1615	GG-308	
2002	V8-4.6L	GP-68	GP-68 SNG	GA-395	GG-308	
2001 - 1999	V8-5.0L	GP-68	GP-68 SNG	GA-158	GG-986	
2001 - 1996	V8-5.0L	GP-68	GP-68 SNG	GA-1614	GG-1872	
2001	V6-4.0L	GP-1		GA-158	GG-986	
2000 - 1999	V6-4.0L	GP-1		GA-158	GG-1872	
2000 - 1998	V6-4.0L	GP-1		GA-1615	GG-1872	
1997	V6-4.0L	GP-1		GA-1614	GG-1872	
1996 - 1995	V6-4.0L	GP-1		GA-1616	GG-1872	
1994 - 1991	V6-4.0L	GP-1		GA-273	GG-1872	

EXPLORER SPORT

2003 - 2001	V6-4.0L	GP-68	GP-68 SNG	GA-1540		
-------------	---------	-------	-----------	---------	--	--

Los filtros Gonher prolongan la vida útil del motor evitando el desgaste prematuro.
Para vehículos anteriores a 1990, consulte nuestro catálogo web en www.grupogonher.com

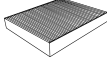
GONHER		ACEITE	SINTÉTICO	AIRE	COMB.	CABINA
AÑO	MOTOR					

FORD (Continúa)

EXPLORER SPORT TRAC

2010 - 2007	V8-4.6L	GP-68	GP-68 SNG	GA-1540	GG-101	
2009	V6-4.0L	GP-2, GP-68	GP-68 SNG	GA-395	GG-101	
2007	V6-4.0L	GP-2, GP-68	GP-68 SNG	GA-395	GG-101	
2003	V6-4.0L	GP-68	GP-68 SNG	GA-158	GG-101	
2002 - 2001	V6-4.0L	GP-68	GP-68 SNG	GA-158	GG-308	





F-100 RANGER

2001 - 1998	V6-3.0L	GP-3600	GP-3600 SNG	GA-1614		
2001	L4-2.3L	GP-3600	GP-3600 SNG	GA-1614		
2000 - 1998	L4-2.5L	GP-3600	GP-3600 SNG	GA-1614		
1997 - 1996	L4-2.3L	GP-1		GA-1616		
1997 - 1996	V6-3.0L			GA-1616		

F-150

2020 - 2011	V8-5.0L	GP-405	GP-405 SNG	GA-437		
2019 - 2018	V6-3.3L	GP-405	GP-405 SNG	GA-437		
2019 - 2017	V6-3.5L Turbo	GP-405	GP-405 SNG	GA-437		
2017 - 2015	V6-3.5L	GP-405	GP-405 SNG	GA-437		
2014	V6-3.5L Turbo	GP-405	GP-405 SNG	GA-437		
2014	V6-3.7L	GP-405	GP-405 SNG	GA-437		
2013	V6-3.7L	GP-405	GP-405 SNG	GA-437	GG-101	
2013	V8-5.0L	GP-405	GP-405 SNG	GA-437	GG-101	
2012 - 2011	V6-3.7L	GP-405	GP-405 SNG	GA-437		
2010 - 2009	V6-4.2L	GP-3600	GP-3600 SNG	GA-1615		
2009	V8-4.6L	GP-68	GP-68 SNG	GA-437		
2009	V8-5.4L	GP-68	GP-68 SNG	GA-437		
2008 - 2004	V8-5.4L	GP-68	GP-68 SNG	GA-1617		
2008	V6-4.2L	GP-3600	GP-3600 SNG	GA-1615	GG-101	GAC-1
2008	V8-4.6L	GP-68	GP-68 SNG	GA-1615		GAC-1
2007 - 2006	V8-4.6L	GP-68, GP-3600	GP-68 SNG, GP-3600 SNG	GA-1615	GG-101	
2007 - 2000	V8-4.6L	GP-68	GP-68 SNG	GA-1615		
2007	V6-4.2L	GP-3600	GP-3600 SNG	GA-1615	GG-101	
2007	V8-5.4L	GP-68	GP-68 SNG	GA-1617		GAC-1
2006 - 2005	V6-4.2L	GP-3600	GP-3600 SNG	GA-1615	GG-986	
2004	V6-4.2L	GP-3600	GP-3600 SNG	GA-1615		
2003 - 1999	V6-4.2L	GP-3600	GP-3600 SNG	GA-1615	GG-986	
2003 - 1999	V8-5.4L	GP-68	GP-68 SNG	GA-8039		
2001 - 2000	V8-5.4L	GP-68	GP-68 SNG	GA-1615, GA-433	GG-1872	
1999 - 1997	V8-4.6L	GP-68	GP-68 SNG	GA-1615		GAC-1
1999	V8-5.4L	GP-68	GP-68 SNG	GA-8039		GAC-1
1998 - 1997	V8-5.4L	GP-68	GP-68 SNG	GA-1615		GAC-1
1998	V6-4.2L	GP-3600	GP-3600 SNG	GA-1615	GG-1872	
1998	V8-5.4L	GP-68	GP-68 SNG	GA-1615		
1998	V8-5.4L	GP-68	GP-68 SNG	GA-1615	GG-1872	

Los filtros Gonher prolongan la vida útil del motor evitando el desgaste prematuro.
Para vehículos anteriores a 1990, consulte nuestro catálogo web en www.grupogonher.com

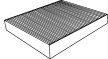
GONHER.		ACEITE	SINTÉTICO	AIRE	COMB.	CABINA
AÑO	MOTOR					

FORD (Continúa)

F-150 (Continúa)

1997	L6-4.9L	GP-1		GA-174		
1997	V6-4.2L	GP-3600	GP-3600 SNG	GA-1615		GAC-1
1997	V8-4.6L	GP-68	GP-68 SNG	GA-1615	GG-1872	
1996 - 1994	V8-5.0L	GP-1		GA-75, GA-186		
1996 - 1994	V8-5.8L	GP-1		GA-75, GA-186	GG-87	
1996	L6-4.9L	GP-1		GA-174, GA-186	GG-1872	
1996	L6-4.9L	GP-1		GA-174	GG-1872	
1995	L6-4.9L	GP-1		GA-174, GA-186	GG-1872	
1995	L6-4.9L	GP-1		GA-174	GG-1872	
1994 - 1991	V6-3.8L	GP-1		GA-74		
1994	L6-4.9L	GP-1		GA-174, GA-186		
1993	L6-4.9L	GP-1		GA-174		
1993	V8-5.0L	GP-1		GA-75		
1993	V8-5.8L	GP-1		GA-75	GG-87	
1990	V6-3.8L	GP-3600	GP-3600 SNG	GA-74		

F-150 HERITAGE

2004	V6-4.2L	GP-3600	GP-3600 SNG	GA-1615	GG-986	
2004	V8-5.4L	GP-68	GP-68 SNG	GA-1615, GA-433	GG-986	





F-200

1991 - 1990	V8-5.0L	GP-1		GA-174		
-------------	---------	------	--	--------	--	--

F-250

2009	V8-4.6L	GP-68	GP-68 SNG	GA-1615		
2008	V8-4.6L	GP-68	GP-68 SNG	GA-1615		GAC-1
2007-2000	V8-4.6L	GP-68	GP-68 SNG	GA-1615		
2001	V8-5.4L	GP-68	GP-68 SNG	GA-1615		
1999 - 1997	V8-5.4L					GAC-1
1999	V8-4.6L	GP-68	GP-68 SNG	GA-1615	GG-986	GAC-1
1998 - 1997	V8-4.6L	GP-68	GP-68 SNG	GA-1615	GG-1872	GAC-1
1997	V8-5.0L	GP-1		GA-174		
1997	V8-5.8L	GP-68	GP-68 SNG	GA-174	GG-1872	GAC-1
1996 - 1995	V8-5.8L	GP-68	GP-68 SNG	GA-174, GA-186	GG-1872	
1996 - 1994	V8-5.8L	GP-1		GA-174, GA-186	GG-1872	
1996 - 1994	V8-7.3L Turbo diésel	GP-562		GA-442		
1996	V8-5.0L	GP-1		GA-174, GA-186	GG-1872	
1996	V8-5.0L	GP-1		GA-174	GG-1872	
1995 - 1994	V8-5.0L	GP-1		GA-174	GG-1872	
1995	V8-4.9L	GP-1		GA-174		
1995	V8-5.0L	GP-1		GA-174, GA-186	GG-1872	
1994	L6-4.9L	GP-1		GA-174, GA-186	GG-1872	
1994	V8-5.0L	GP-1		GA-174, GA-186	GG-1872	
1994	V8-7.3L Diésel	GP-562		GA-442		
1993 - 1992	V8-5.0L	GP-1		GA-174	GG-1872	

Los filtros Gonher prolongan la vida útil del motor evitando el desgaste prematuro.
Para vehículos anteriores a 1990, consulte nuestro catálogo web en www.grupogonher.com

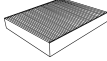
GONHER		ACEITE	SINTÉTICO	AIRE	COMB.	CABINA
AÑO	MOTOR					

FORD (Continúa)

F-250 (Continúa)

1993 - 1992	V8-5.8L	GP-1		GA-174	GG-1872	
1993	V8-7.3L Turbo diésel	GP-3766		GA-3501		

F-250 HD

1997	V8-5.8L					GAC-1
1997	V8-7.3L Turbo diésel	GP-562		GA-442		
1997	V8-7.5L					GAC-1





F-250 SUPER DUTY

2019 - 2017	V8-6.2L	GP-68	GP-68 SNG	GA-2343		
2019 - 2017	V8-6.7L Turbo diésel			GA-2342		
2019	V8-6.7L Turbo diésel	G-330		GA-2342		
2018 - 2017	V8-6.7L Turbo diésel	GP-65		GA-2342		
2016 - 2011	V8-6.7L Turbo diésel	GP-65		GA-439	G-450	
2010 - 2008	V8-6.4L Turbo diésel	G-3752		GA-550	G-1048	
2007 - 2005	V8-5.4L			GA-1617		GAC-1
2007 - 2005	V8-6.0L Turbo diésel	G-3752		GA-4999		
2007	V10 6.8L	GP-68	GP-68 SNG	GA-1571	GG-101	
2007	V8-5.4L	GP-68	GP-68 SNG	GA-1617	GG-101	
2006 - 2005	V8-6.0L Turbo diésel	G-3752		GA-4999	G-1047	
2004 - 2003	V8-6.0L Turbo diésel	G-3752		GA-4999		GAC-1
2004 - 2002	V10 6.8L	GP-68	GP-68 SNG	GA-1615	GG-1872	
2004 - 2001	V10 6.8L					GAC-1
2004 - 2001	V8-5.4L					GAC-1
2003 - 2001	V8-7.3L Turbo diésel	GP-562		GA-780		GAC-1
2000	V10 6.8L	GP-68	GP-68 SNG	GA-1615	GG-1872	
2000	V8-7.3L Turbo diésel	GP-562		GA-780		
1999	V8-7.3L Turbo diésel	GP-562		GA-780, GA-472		

F-350

2016 - 2011	V8-6.2L	GP-68	GP-68 SNG	GA-437		
2009	V8-5.4L	GP-68	GP-68 SNG	GA-437		
2008	V8-5.4L	GP-68	GP-68 SNG	GA-1617		
2007	V8-5.4L	GP-68	GP-68 SNG	GA-1617		GAC-1
2006 - 2004	V8-5.4L	GP-68	GP-68 SNG	GA-1617		
2003 - 2000	V8-5.4L	GP-68	GP-68 SNG	GA-433		
1999	V8-5.4L	GP-68	GP-68 SNG	GA-433		GAC-1
1998 - 1997	V8-5.0L	GP-1		GA-1615		
1997 - 1994	V8-7.3L Turbo diésel	GP-562		GA-442		
1997	V8-5.8L	GP-68	GP-68 SNG	GA-174, GA-3501	GG-1872	
1997	V8-5.8L	GP-1		GA-85	GG-87	GAC-1
1997	V8-7.5L					GAC-1
1996 - 1995	V8-5.0L	GP-1		GA-1615, GA-186		
1996	V8-5.8L	GP-68	GP-68 SNG	GA-174, GA-186	GG-1872	
1996	V8-5.8L	GP-68	GP-68 SNG	GA-174	GG-1872	
1995 - 1993	V8-5.8L	GP-1		GA-85	GG-87	
1995	V8-5.0L	GP-1		GA-1615		
1995	V8-5.8L	GP-68	GP-68 SNG	GA-174, GA-186	GG-1872	
1995	V8-7.5L	GP-1		GA-174, GA-186	GG-1872	
1994 - 1990	V8-5.0L	GP-1		GA-74, GA-174	GG-47	
1994	V8-7.3L Diésel	GP-562		GA-3501		

Los filtros Gonher prolongan la vida útil del motor evitando el desgaste prematuro.
Para vehículos anteriores a 1990, consulte nuestro catálogo web en www.grupogonher.com

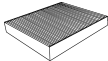
GONHER.		ACEITE	SINTÉTICO	AIRE	COMB.	CABINA
AÑO	MOTOR					

FORD (Continúa)

F-350 (Continúa)

1994	V8-7.3L Turbo diésel	GP-3766		GA-3501	G-178	
1993	V8-5.8L	GP-1		GA-174	GG-1872	
1993	V8-7.3L Diésel			GA-442		
1993	V8-7.3L Turbo diésel			GA-3501		
1993	V8-7.3L Turbo diésel	GP-3766		GA-3501		
1990	V8-5.8L	GP-1		GA-174	GG-47	

F-350 SUPER DUTY

2019 - 2017	V8-6.2L			GA-2343		
2019 - 2017	V8-6.7L Turbo diésel			GA-2342		
2018 - 2017	V8-6.2L	GP-68	GP-68 SNG	GA-2343		
2010	V8-6.2L	GP-68	GP-68 SNG	GA-437		
2009-2008	V8-5.4L	GP-68	GP-68 SNG	GA-437	GG-101	
2007-2005	V8-6.0L Turbo diésel	G-3752		GA-4999		
2007	V10 6.8L	GP-68	GP-68 SNG		GG-101	
2007	V8-5.4L	GP-68	GP-68 SNG	GA-1617	GG-101	
2007	V8-5.4L	GP-68	GP-68 SNG	GA-1617	GG-101	GAC-1
2007	V8-6.0L Turbo diésel	G-3752		GA-4999	G-1047	
2006-2005	V8-5.4L	GP-3600	GP-3600 SNG	GA-1617	GG-101	GAC-1
2004-2003	V8-6.0L Turbo diésel	G-3752		GA-4999		GAC-1
2004-2001	V10 6.8L					GAC-1
2004	V8-5.4L	GP-68	GP-68 SNG	GA-1615	GG-1872	GAC-1
2004	V8-6.0L Turbo diésel	G-3752		GA-4999	G-1047	
2003-2002	V8-7.3L Turbo diésel	GP-562		GA-780	G-862	
2003-2001	V8-5.4L	GP-68	GP-68 SNG	GA-1615	GG-986	GAC-1
2003-2001	V8-7.3L Turbo diésel	GP-562		GA-780		GAC-1
2002-2001	V10 6.8L	GP-68	GP-68 SNG	GA-1615	GG-1872	
2001	V8-5.4L	GP-68	GP-68 SNG	GA-1615, GA-433	GG-986	
2000-1999	V8-5.4L	GP-68	GP-68 SNG	GA-1615	GG-986	
2000	V8-7.3L Turbo diésel	GP-562		GA-780		
1999	V10 6.8L	GP-68	GP-68 SNG	GA-1615	GG-1872	
1999	V8-5.4L	GP-68	GP-68 SNG	GA-1615	GG-1872	
1999	V8-7.3L Turbo diésel			GA-780, GA-472		

FIESTA

2019 - 2014	L4-1.6L Turbo	GP-58	GP-58 SNG	GA-430		
2019 - 2011	L4-1.6L	GP-58	GP-58 SNG	GA-430		
2010-2003	L4-1.6L	GP-58	GP-58 SNG	GA-284	GG-986	
2008	L4-2.0L	GP-58	GP-58 SNG	GA-284		
2001-1998	L4-1.3L	GP-58	GP-58 SNG	GA-179	GG-82	GAC-11
2001	L4-1.6L	GP-58	GP-58 SNG	GA-179	GG-82	
2000-1998	L4-1.4L	GP-58	GP-58 SNG	GA-179	GG-82	GAC-11

FIESTA IKON





2015 - 2011	L4-1.6L	GP-58	GP-58 SNG	GA-430		
2004-2003	L4-1.6L	GP-58	GP-58 SNG	GA-284		
2002	L4-1.6L	GP-58	GP-58 SNG	GA-179		

FIGO

2020-2019	L3-1.5L	GP-58	GP-58 SNG	GA-430		
2018-2016	L4-1.5L	GP-58	GP-58 SNG	GA-430		

FIVE HUNDRED

2007-2005	V6-3.0L	GP-68	GP-68 SNG	GA-771	GG-986	
-----------	---------	-------	-----------	--------	--------	--

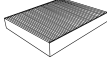
GONHER		ACEITE	SINTÉTICO	AIRE	COMB.	CABINA
AÑO	MOTOR					

FORD (Continúa)

FLEX

2009	V6-3.5L			GA-1542		
------	---------	--	--	---------	--	--

FOCUS

2018 - 2017	L4-2.3L Turbo	GP-58	GP-58 SNG	GA-226R	GG-101	
2018 - 2014	L4-2.0L	GP-58	GP-58 SNG	GA-226R		
2018 - 2014	L4-2.0L Turbo	GP-58	GP-58 SNG	GA-226R		
2013 - 2012	L4-2.0L	GP-58	GP-58 SNG	GA-226R	GG-308	
2013	L4-2.0L Turbo	GP-58	GP-58 SNG	GA-226R	GG-308	
2011 - 2008	L4-2.0L	GP-58	GP-58 SNG	GA-1570	GG-308	GAC-2295 ⁽¹⁾
2011 - 2007	L5-2.5L Turbo			GA-2216		
2007-2006	L4-2.0L	GP-58	GP-58 SNG	GA-168	GG-986	
2007-2005	L4-2.3L	GP-58	GP-58 SNG	GA-226R	GG-986	
2005-2000	L4-2.0L	GP-128		GA-168	GG-986	GAC-7
2004-2003	L4-2.3L	GP-58	GP-58 SNG	GA-168	GG-986	

FREESTAR

2007-2006	V6-3.9L	GP-3600	GP-3600 SNG	GA-479	GG-308	GAC-2286 ⁽¹⁾
2007-2006	V6-4.2L	GP-3600	GP-3600 SNG	GA-479	GG-308	GAC-2286 ⁽¹⁾
2005-2004	V6-3.9L	GP-3600	GP-3600 SNG	GA-479	GG-986	GAC-2286 ⁽¹⁾
2005-2004	V6-4.2L	GP-3600	GP-3600 SNG	GA-479	GG-986	GAC-2286 ⁽¹⁾

FREESTYLE

2007-2005	V6-3.0L	GP-68	GP-68 SNG	GA-771	GG-986	
-----------	---------	-------	-----------	--------	--------	--

FUSION

2020 - 2014	L4-1.5L Turbo	GP-58	GP-58 SNG	GA-1573		
2020 - 2013	L4-2.0L Turbo	GP-58	GP-58 SNG	GA-1573		
2020 - 2013	L4-2.5L	GP-58	GP-58 SNG	GA-1573		
2019 - 2017	L4-2.0L Híbrido	GP-58	GP-58 SNG			
2012 - 2011	V6-3.5L	GP-405	GP-405 SNG	GA-1542		
2012 - 2010	L4-2.5L	GP-58	GP-58 SNG	GA-1572		
2012 - 2010	V6-3.0L	GP-405	GP-405 SNG	GA-1544		
2010 - 2009	L4-2.3L	G-70		GA-1572		
2009-2006	V6-3.0L	GP-68	GP-68 SNG	GA-1544		
2008-2007	L4-2.3L	GP-58	GP-58 SNG	GA-1572		
2006	L4-2.3L	G-70		GA-1572		

GHIA

1994 - 1991	V6-3.0L	GP-3600	GP-3600 SNG	GA-217	GG-47	
1991	L4-2.3L	GP-3600	GP-3600 SNG	GA-274	GG-47	

GRAND MARQUIS

2004 - 1998	V8-4.6L	GP-68	GP-68 SNG	GA-5056	GG-986	
1997 - 1992	V8-4.6L	GP-68	GP-68 SNG	GA-5056	GG-47	
1991	V8-4.6L	GP-68	GP-68 SNG	GA-5056		

IKON





2007-2003	L4-1.6L	GP-3600	GP-3600 SNG	GA-179	GG-82	
-----------	---------	---------	-------------	--------	-------	--

KA

2008-2001	L4-1.6L	GP-128		GA-280	GG-986	GAC-1
-----------	---------	--------	--	--------	--------	-------

(1) Nuevo

Los filtros Gonher prolongan la vida útil del motor evitando el desgaste prematuro.
Para vehículos anteriores a 1990, consulte nuestro catálogo web en www.grupogonher.com

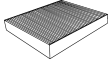
GONHER.		ACEITE	SINTÉTICO	AIRE	COMB.	CABINA
AÑO	MOTOR					

FORD (Continúa)

LOBO

2017 - 2015	V6-3.5L Turbo	GP-405	GP-405 SNG	GA-437		
2017 - 2013	V8-5.0L	GP-405	GP-405 SNG	GA-437		
2014	V8-6.2L	GP-68	GP-68 SNG	GA-437	GG-101	
2013	V8-6.2L	GP-68	GP-68 SNG	GA-437		
2012	V8-5.0L	GP-405	GP-405 SNG	GA-437	GG-101	
2012	V8-6.2L	GP-68	GP-68 SNG	GA-1615	GG-101	
2011	V8-5.0L	GP-68	GP-68 SNG	GA-437	GG-101	
2011	V8-6.2L	GP-68	GP-68 SNG	GA-437	GG-101	
2010 - 2009	V8-4.6L	GP-68	GP-68 SNG	GA-437	GG-101	
2010 - 2009	V8-5.4L	GP-68	GP-68 SNG	GA-437		
2008 - 2007	V8-4.6L	GP-3600	GP-3600 SNG	GA-1615	GG-101	
2008	V8-5.4L	GP-68	GP-68 SNG	GA-437	GG-101	
2007 - 2006	V8-5.4L	GP-3600	GP-3600 SNG	GA-1617	GG-101	
2006 - 1999	V8-4.6L	GP-3600	GP-3600 SNG	GA-1615	GG-986	
2005 - 2003	V8-5.4L	GP-3600	GP-3600 SNG	GA-1617	GG-986	
2002 - 1999	V8-5.4L	GP-68	GP-68 SNG	GA-1615	GG-986	
1998	V8-4.6L	GP-3600	GP-3600 SNG	GA-1615	GG-1872	
1997	V8-4.6L	GP-3600	GP-3600 SNG	GA-1615	GG-986	





MONDEO

2007 - 2001	L4-2.0L	GP-58, G-70	GP-58 SNG	GA-196	GG-915	GAC-9
2007 - 2001	V6-2.5L	GP-68	GP-68 SNG	GA-196	GG-915	GAC-9
2005 - 2004	V6-3.0L	GP-68	GP-68 SNG	GA-196		

MUSTANG

2019 - 2016	L4-2.3L Turbo	GP-58	GP-58 SNG			
2019 - 2015	V8-5.0L	GP-405	GP-405 SNG			
2017 - 2016	V8-5.2L				GG-101	
2017 - 2015	V6-3.7L	GP-405	GP-405 SNG			
2014 - 2013	V8-5.8L	GP-68	GP-68 SNG		GG-101	
2014 - 2011	V6-3.7L	GP-405	GP-405 SNG	GA-1541	GG-101	
2014	V8-5.0L	GP-405	GP-405 SNG	GA-1541	GG-101	
2013 - 2012	V8-5.0L	GP-405	GP-405 SNG	GA-1541		
2012 - 2010	V8-5.4L	GP-68	GP-68 SNG	GA-1548	GG-101	
2011	V8-5.0L	GP-405	GP-405 SNG	GA-1541	GG-101	
2010 - 2005	V6-4.0L	GP-68	GP-68 SNG	GA-1548	GG-101	
2010	V8-4.6L	GP-68	GP-68 SNG	GA-1541	GG-101	
2009 - 2007	V8-5.4L	GP-68	GP-68 SNG		GG-101	
2009 - 2006	V8-4.6L	GP-68	GP-68 SNG	GA-1548	GG-101	
2005	V8-4.6L	GP-68	GP-68 SNG	GA-1548	GG-986	
2004 - 2000	V8-4.6L	GP-68	GP-68 SNG	GA-1615	GG-986	
2004 - 1994	V6-3.8L	GP-3600	GP-3600 SNG	GA-175		
2004	V6-3.9L	GP-3600	GP-3600 SNG	GA-175	GG-986	
2000	V8-5.4L	GP-68	GP-68 SNG		GG-101	
1999 - 1996	V8-4.6L	GP-68	GP-68 SNG	GA-1615	GG-47	
1995 - 1994	V8-5.0L	GP-1		GA-175	GG-47	
1995 - 1993	V8-5.0L	GP-1		GA-78	GG-20	
1995	V8-5.8L	GP-68	GP-68 SNG		GG-101	
1993	L4-2.3L	GP-58	GP-58 SNG			

Los filtros Gonher prolongan la vida útil del motor evitando el desgaste prematuro.
Para vehículos anteriores a 1990, consulte nuestro catálogo web en www.grupogonher.com

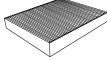
GONHER		ACEITE	SINTÉTICO	AIRE	COMB.	CABINA
AÑO	MOTOR					

FORD (Continúa)
MUSTANG (Continúa)

1991 - 1990	L4-2.3L			GA-176		
-------------	---------	--	--	--------	--	--

MYSTIQUE

2000 - 1995	V6-2.5L	GP-68	GP-68 SNG	GA-128		
1995	L4-2.0L	GP-81	GP-81 SNG	GA-127		

P-350

1994 - 1991	V8-5.8L	GP-9		GA-174	GG-1872	
1990	V8-5.8L	GP-9		GA-174		

PROBE

1997 - 1993	L4-2.0L			GA-432	GG-268	
1997 - 1993	V6-2.5L			GA-432	GG-268	

RANGER

2020 - 2019	L4-2.5L	GP-68	GP-68 SNG	GA-3596R		
2018 - 2016	L4-2.2L Turbo diésel			GA-3596R		
2018 - 2015	L4-2.5L	GP-68	GP-68 SNG	GA-3596R		GAC-2295 ⁽¹⁾
2017 - 2015	L4-2.5L	GP-68	GP-68 SNG	GA-3596R		
2014 - 2013	L4-2.5L	GP-58	GP-58 SNG			GAC-2295 ⁽¹⁾
2012 - 2006	L4-2.3L	GP-58	GP-58 SNG	GA-158	GG-308	
2008 - 2002	V6-3.0L	GP-3600	GP-3600 SNG	GA-158		
2007 - 2004	V6-4.0L	GP-68	GP-68 SNG	GA-158	GG-308	
2005 - 2004	L4-2.3L	GP-3600	GP-3600 SNG	GA-158	GG-308	
2003 - 2002	L4-2.3L	GP-3600	GP-3600 SNG	GA-158		
2002 - 2000	V6-4.0L				GG-210	
2002	V6-4.0L	GP-68	GP-68 SNG	GA-158	GG-210	
2001 - 2000	L4-2.5L	GP-68	GP-68 SNG		GG-210	
2001 - 2000	V6-3.0L	GP-3600	GP-3600 SNG	GA-158	GG-210	
2001	L4-2.3L	GP-3600	GP-3600 SNG	GA-158	GG-210	
1999 - 1998	L4-2.5L	GP-68	GP-68 SNG			
1999 - 1993	V6-3.0L	GP-3600	GP-3600 SNG	GA-158		
1997 - 1993	L4-2.3L	GP-3600	GP-3600 SNG	GA-158		





SABLE

2001 - 2000	V6-3.0L	GP-68	GP-68 SNG	GA-224		
1999 - 1996	V6-3.0L	GP-68	GP-68 SNG	GA-217		
1995 - 1994	V6-3.8L	GP-3600	GP-3600 SNG	GA-273		

TAURUS

2007 - 2003	V6-3.0L	GP-3600	GP-3600 SNG	GA-224		
2002 - 2000	V6-3.0L	GP-68	GP-68 SNG	GA-224	GG-307	
1999 - 1996	V6-3.0L	GP-68	GP-68 SNG	GA-217		
1995 - 1993	V6-3.0L	GP-3600	GP-3600 SNG	GA-273		
1995 - 1993	V6-3.8L	GP-3600	GP-3600 SNG	GA-273	GG-47	
1991 - 1990	L4-2.5L			GA-176		
1991 - 1990	V6-3.0L			GA-176		

(1) Nuevo

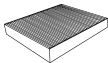
GONHER.		ACEITE	SINTÉTICO	AIRE	COMB.	CABINA
AÑO	MOTOR					

FORD (Continúa)

TAURUS (Continúa)

1991 - 1990	V6-3.8L	GP-3600	GP-3600 SNG	GA-273	GG-47	
-------------	---------	---------	-------------	--------	-------	--

THUNDERBIRD

2005 - 2002	V8-3.9L	GP-457		GA-479	GG-986	
1997 - 1995	V6-3.8L	GP-1		GA-74	GG-29	
1997 - 1994	V8-4.6L	GP-68	GP-68 SNG	GA-275	GG-92	
1994 - 1992	V6-3.8L	GP-3600	GP-3600 SNG	GA-275	GG-92	
1993 - 1991	V8-5.0L	GP-1		GA-275	GG-30	
1991 - 1990	V6-3.8L	GP-3600	GP-3600 SNG	GA-275	GG-30	

TOPAZ

1994 - 1993	L4-2.3L	GP-9		GA-217	GG-47	
1992 - 1990	L4-2.3L	GP-9		GA-274	GG-47	

TRANSIT

2019 - 2015	V6-3.7L	GP-405	GP-405 SNG			
2016 - 2012	L4-2.2L Turbo diésel	GP-6714		GA-1196		
2011 - 2007	L4-2.2L Turbo diésel	G-341		GA-27161		

TRANSIT CONNECT

2016 - 2014	L4-1.6L Turbo			GA-226R		
-------------	---------------	--	--	---------	--	--

TRANSIT-250

2019 - 2015	V6-3.5L Turbo	GP-406, GP-405				
-------------	---------------	----------------	--	--	--	--

TRANSIT-350

2018 - 2017	V6-3.7L			GA-2228 ⁽¹⁾		
-------------	---------	--	--	------------------------	--	--

WINDSTAR

2003 - 1999	V6-3.8L	GP-3600	GP-3600 SNG	GA-1616	GG-986	GAC-2286 ⁽¹⁾
2000 - 1999	V6-3.0L			GA-273	GG-986	GAC-2286 ⁽¹⁾
1998 - 1996	V6-3.8L	GP-3600	GP-3600 SNG	GA-1616	GG-1872	
1998 - 1995	V6-3.0L			GA-273	GG-1872	
1995	V6-3.8L	GP-3600	GP-3600 SNG	GA-273	GG-1872	

GEO

TRACKER

1995 - 1994	L4-1.6L	GP-58	GP-58 SNG	GA-7617	GG-7196	
1993	L4-1.6L	GP-58	GP-58 SNG	GA-166	GG-7196	

GIANT MOTORS

GF900

2008	L4-1.0L	GP-157			GG-251	
------	---------	--------	--	--	--------	--





GMC

ACADIA

2021	L4-2.0L Turbo	GP-2351 ⁽¹⁾				
2020 - 2017	L4-2.5L			GA-2324		
2020 - 2017	V6-3.6L			GA-2324		
2020	L4-2.0L Turbo	GP-2351 ⁽¹⁾		GA-2324		
2019	V6-3.6L	GP-405	GP-405 SNG	GA-2324		

(1) Nuevo

Los filtros Gonher prolongan la vida útil del motor evitando el desgaste prematuro.
Para vehículos anteriores a 1990, consulte nuestro catálogo web en www.grupogonher.com

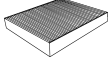
GONHER		ACEITE	SINTÉTICO	AIRE	COMB.	CABINA
AÑO	MOTOR					

GMC (Continúa)

ACADIA (Continúa)

2018 - 2017	V6-3.6L	GP-405	GP-405 SNG	GA-3083		
2016 - 2011	V6-3.6L	GP-405	GP-405 SNG	GA-3083		
2010 - 2007	V6-3.6L	GP-406	GP-406 SNG	GA-3083		

C1500

1997 - 1993	V8-5.7L	GP-5		GA-673R	GG-46	
1996 - 1993	V6-4.3L	GP-3980		GA-192	GG-46	
1995 - 1994	V8-6.5L Turbo diésel			GA-3492		
1993	V8-6.2L Diésel			GA-3492		

C2500

1995	V8-6.5L Turbo diésel			GA-3492		
1994	V8-6.5L Diésel			GA-3492		

C2500 SUBURBAN

1999	V8-7.4L	GP-408				
------	---------	--------	--	--	--	--

C3500

1993	V8-6.2L Diésel			GA-3492		
------	----------------	--	--	---------	--	--

CANYON

2020 - 2015	L4-2.5L			GA-2314		
2020 - 2015	V6-3.6L			GA-2314		
2012 - 2008	L5-3.7L	GP-3675		GA-266		
2007	L4-2.9L	GP-44		GA-415		
2007	L5-3.7L	GP-3675		GA-415		
2006	L5-3.5L	GP-3675		GA-415		
2005	L5-3.5L	GP-3675		GA-415	GG-581	
2004	L4-2.8L	GP-44		GA-415	GG-581	

ENVOY

2009	L6-4.2L	GP-3675		GA-414R	GG-209	
2009	V8-5.3L			GA-414R		
2007 - 2006	V8-5.3L			GA-414R		
2007 - 2002	L6-4.2L	GP-3675		GA-414R	GG-209	
2005 - 2002	L6-4.2L				GG-209	
2005	V8-5.3L			GA-414R	GG-209	

ENVOY XL

2004 - 2003	V8-5.3L			GA-414R		
-------------	---------	--	--	---------	--	--

ENVOY XUV

2004	V8-5.3L			GA-414R		
------	---------	--	--	---------	--	--

G2500

1995 - 1994	V8-6.5L Diésel			GA-3492		
-------------	----------------	--	--	---------	--	--

G3500





1994	V8-6.5L Diésel			GA-3492		
------	----------------	--	--	---------	--	--

JIMMY

2000 - 1993	V6-4.3L			GA-165		
1996	V6-4.3L	GP-3980		GA-165	GG-46	
1995 - 1994	V6-4.3L	GP-3980		GA-3588	GG-46	

K1500

1994	V8-6.5L Turbo diésel			GA-3492		
1993	V8-6.2L Diésel			GA-3492		

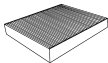
GONHER		ACEITE 	SINTÉTICO 	AIRE 	COMB. 	CABINA 
AÑO	MOTOR					

GMC (Continúa)

K2500

2000 - 1999	V8-7.4L	GP-408				
1995 - 1994	V8-6.5L Turbo diésel			GA-3492		

K2500 SUBURBAN

1999	V8-7.4L	GP-408				
1995 - 1994	V8-6.5L Diésel			GA-3492		

K3500

2000 - 1999	V8-7.4L	GP-408				
1995 - 1993	V8-6.5L Diésel			GA-3492		

SAFARI

2005 - 1993	V6-4.3L			GA-165		
2004	V6-4.3L	GP-46		GA-165	GG-46	
2001	V6-4.3L	GP-3980		GA-165	GG-46	
1994	V6-4.3L	GP-3980		GA-165	GG-46	

SAVANA 1500

2001	V8-5.7L	GP-205				
1999	V8-5.7L	GP-205				

SIERRA

2017 - 2014	V8-5.3L	GP-405	GP-405 SNG	GA-348		
2017 - 2014	V8-6.2L	GP-405	GP-405 SNG	GA-348		
2013 - 2008	V8-6.2L	GP-406	GP-406 SNG	GA-348		
2013 - 2007	V8-5.3L	GP-406	GP-406 SNG	GA-348		

SIERRA 1500

2021 - 2020	L6-3.0L Turbo diésel	GP-2351 ⁽¹⁾				
2021	L4-2.7L Turbo	GP-2351 ⁽¹⁾				
2020 - 2019	L4-2.7L Turbo	GP-2351 ⁽¹⁾		GA-2321		
2020 - 2019	V6-4.3L			GA-2321		
2020 - 2019	V8-5.3L			GA-2321		
2020	V8-6.2L			GA-2321		
2019	V8-6.2L	GP-406, GP-405		GA-2321		
2018 - 2014	V8-6.2L	GP-406, GP-405				

SIERRA 1500 LIMITED

2019	V8-5.3L			GA-2321		
------	---------	--	--	---------	--	--

SIERRA 2500 HD

2019 - 2017	V8-6.6L Turbo diésel			GA-2353		
-------------	----------------------	--	--	---------	--	--

SIERRA 3500

2006 - 2001	V8-6.6L Turbo diésel	GP-9100				
-------------	----------------------	---------	--	--	--	--





SIERRA 3500 HD

2019 - 2017	V8-6.6L Turbo diésel			GA-2353		
-------------	----------------------	--	--	---------	--	--

SONOMA

2004 - 1993	V6-4.3L			GA-165		
2003 - 1994	L4-2.2L			GA-165		
2000 - 1999	V6-4.3L	GP-3980		GA-165	GG-266	

(1) Nuevo

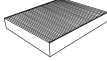
GONHER		ACEITE	SINTÉTICO	AIRE	COMB.	CABINA
AÑO	MOTOR					

FILTROS

GMC

GMC (Continúa)

TERRAIN

2020 - 2018	L4-1.5L Turbo			GA-2315 ⁽¹⁾		
2020 - 2018	L4-2.0L Turbo	GP-406	GP-406 SNG	GA-2315 ⁽¹⁾		
2019 - 2018	L4-1.6L Turbo diésel			GA-2315 ⁽¹⁾		
2017 - 2013	V6-3.6L	GP-405	GP-405 SNG	GA-3138		
2012 - 2011	V6-3.0L	GP-405	GP-405 SNG	GA-3138		

TYPHOON

1993	V6-4.3L Turbo			GA-165		
------	---------------	--	--	--------	--	--

YUKON

2021	L6-3.0L	GP-2351 ⁽¹⁾				
2019 - 2015	V8-6.2L	GP-405	GP-405 SNG	GA-348		
2014 - 2011	V8-6.2L	GP-406	GP-406 SNG	GA-348		
2010 - 2000	V8-5.3L	GP-406	GP-406 SNG	GA-348		
2009 - 2007	V8-6.2L	GP-406	GP-406 SNG	GA-348		

HONDA

ACCORD

2020 - 2018	L4-1.5L Turbo	GP-149	GP-149 SNG			GAC-92
2020 - 2018	L4-2.0L Turbo	GP-149	GP-149 SNG			GAC-92
2017 - 2013	L4-2.4L	GP-149	GP-149 SNG	GA-190		GAC-92
2017 - 2013	V6-3.5L	GP-149	GP-149 SNG	GA-191		GAC-92
2012 - 2008	L4-2.4L	GP-149	GP-149 SNG	GA-193		GAC-92
2012 - 2008	V6-3.5L	GP-149	GP-149 SNG	GA-171		GAC-92
2007 - 2003	L4-2.4L	GP-149	GP-149 SNG	GA-138		GAC-92
2007 - 2003	V6-3.0L	GP-149	GP-149 SNG	GA-170	GG-161	GAC-13
2007 - 2003	V6-3.0L	GP-149	GP-149 SNG	GA-269	GG-161	GAC-13
2007	V6-3.0L Híbrido	GP-149	GP-149 SNG	GA-170	GG-161	GAC-13
2006 - 2005	V6-3.0L	GP-149	GP-149 SNG	GA-269		
2005	V6-3.0L Híbrido	GP-149	GP-149 SNG	GA-170	GG-161	GAC-13
2002 - 1998	L4-2.3L	GP-149	GP-149 SNG	GA-163	GG-160	
2002 - 1998	V6-3.0L	GP-149	GP-149 SNG	GA-170	GG-161	
1997 - 1994	L4-2.2L	GP-149	GP-149 SNG	GA-514	GG-160	
1993	L4-2.2L	GP-149	GP-149 SNG	GA-386	GG-160	
1992 - 1990	L4-2.2L				GG-184	

ACCORD CROSSTOUR

2011 - 2010	V6-3.5L	GP-149	GP-149 SNG	GA-171		GAC-92
-------------	---------	--------	------------	--------	--	--------

BR-V

2020 - 2018	L4-1.5L	GP-149	GP-149 SNG	GA-2055		
-------------	---------	--------	------------	---------	--	--

CITY

2020 - 2015	L4-1.5L	GP-149	GP-149 SNG	GA-2055		
2014 - 2010	L4-1.5L	GP-149	GP-149 SNG	GA-347		

CIVIC

2020 - 2016	L4-1.5L Turbo			GA-1720 ⁽¹⁾		
2020 - 2016	L4-2.0L	GP-149	GP-149 SNG	GA-5022 ⁽¹⁾		GAC-92
2019 - 2018	L4-2.0L Turbo	GP-149	GP-149 SNG	GA-5022 ⁽¹⁾		GAC-92
2019 - 2016	L4-1.5L Turbo	GP-149	GP-149 SNG	GA-1720 ⁽¹⁾		GAC-92
2015 - 2012	L4-1.8L	GP-149	GP-149 SNG	GA-1113 ⁽¹⁾		GAC-92
2015 - 2012	L4-2.4L	GP-149	GP-149 SNG			GAC-92
2013	L4-1.5L Híbrido	GP-149	GP-149 SNG			GAC-92
2012	L4-1.5L Eléctrico	GP-149	GP-149 SNG			
2011 - 2006	L4-1.8L	GP-149	GP-149 SNG	GA-340		GAC-92

(1) Nuevo

Los filtros Gonher prolongan la vida útil del motor evitando el desgaste prematuro.
Para vehículos anteriores a 1990, consulte nuestro catálogo web en www.grupogonher.com

GONHER.		ACEITE	SINTÉTICO	AIRE	COMB.	CABINA
AÑO	MOTOR					

HONDA (Continúa)

CIVIC (Continúa)

2011 - 2006	L4-2.0L	GP-149	GP-149 SNG	GA-2225 ⁽¹⁾		GAC-92
2011	L4-1.3L Eléctrico	GP-149	GP-149 SNG			
2010 - 2006	L4-1.3L Híbrido	GP-149	GP-149 SNG			GAC-92
2005 - 2003	L4-1.3L Híbrido					GAC-2274 ⁽¹⁾
2005 - 2002	L4-1.7L	GP-149	GP-149 SNG	GA-194		GAC-2274 ⁽¹⁾
2005 - 2002	L4-2.0L	GP-149	GP-149 SNG	GA-184		GAC-2274 ⁽¹⁾
2001	L4-1.7L	GP-91	GP-91 SNG	GA-194		GAC-2274 ⁽¹⁾
2000 - 1999	L4-1.6L	GP-149	GP-149 SNG	GA-384, GA-172	GG-160	GAC-13
1998	L4-1.6L	GP-149	GP-149 SNG	GA-172	GG-160	GAC-13
1997 - 1996	L4-1.6L	GP-149	GP-149 SNG	GA-384, GA-172	GG-160	GAC-13
1995 - 1993	L4-1.5L	GP-149	GP-149 SNG	GA-381		
1995 - 1993	L4-1.6L	GP-149	GP-149 SNG	GA-381	GG-160	
1993 - 1992	L4-1.5L				GG-184	
1993 - 1992	L4-1.6L				GG-184	
1991 - 1990	L4-1.5L				GG-190	
1991 - 1990	L4-1.6L				GG-190	

CIVIC DEL SOL

1993	L4-1.5L				GG-184	
1993	L4-1.6L				GG-184	

CROSSTOUR

2014 - 2012	V6-3.5L	GP-149	GP-149 SNG	GA-171		GAC-92
-------------	---------	--------	------------	--------	--	--------

CR-V

2020 - 2017	L4-1.5L Turbo	GP-149	GP-149 SNG	GA-1720 ⁽¹⁾		
2020	L4-1.5L Turbo	GP-149	GP-149 SNG	GA-1720		
2019 - 2017	L4-2.4L	GP-149	GP-149 SNG			GAC-92
2017	L4-1.5L Turbo			GA-1720 ⁽¹⁾		
2016 - 2015	L4-2.4L	GP-149	GP-149 SNG	GA-5200		GAC-92
2014 - 2012	L4-2.4L	GP-149	GP-149 SNG	GA-722		GAC-92
2011 - 2010	L4-2.4L	GP-149	GP-149 SNG	GA-321		GAC-92
2009	L4-2.4L	GP-149	GP-149 SNG	GA-341	GG-160	GAC-92
2008 - 2007	L4-2.4L	GP-149	GP-149 SNG	GA-341		GAC-92
2006 - 2005	L4-2.4L	GP-149	GP-149 SNG	GA-184		GAC-2274 ⁽¹⁾
2004 - 2002	L4-2.4L	GP-149	GP-149 SNG	GA-184	GG-160	GAC-2274 ⁽¹⁾
2001 - 1997	L4-2.0L	GP-149	GP-149 SNG	GA-172	GG-160	GAC-6

CRX

1991 - 1990	L4-1.5L				GG-190	
1991 - 1990	L4-1.6L				GG-190	





CR-Z

2015 - 2013	L4-1.5L Híbrido	GP-149	GP-149 SNG			
-------------	-----------------	--------	------------	--	--	--

ELEMENT

2011 - 2006	L4-2.4L			GA-2225 ⁽¹⁾		GAC-2274 ⁽¹⁾
2007	L4-2.4L	GP-149	GP-149 SNG	GA-2225 ⁽¹⁾		GAC-2274 ⁽¹⁾
2006	L4-2.4L			GA-184, GA-2225		GAC-2274 ⁽¹⁾
2005 - 2003	L4-2.4L					GAC-2274 ⁽¹⁾
2005 - 2003	L4-2.4L			GA-184		GAC-2274 ⁽¹⁾

(1) Nuevo

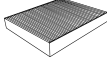
GONHER		ACEITE	SINTÉTICO	AIRE	COMB.	CABINA
AÑO	MOTOR					

HONDA (Continúa)

FIT

2020 - 2018	L4-1.5L	GP-149		GA-345		
2019 - 2015	L4-1.5L	GP-149	GP-149 SNG	GA-345		
2014 - 2009	L4-1.5L	GP-149	GP-149 SNG	GA-347		
2008 - 2006	L4-1.5L	GP-149	GP-149 SNG	GA-182		

HR-V

2020	L4-1.8L	GP-149				
2019 - 2016	L4-1.8L	GP-149	GP-149 SNG	GA-2051		

INSIGHT

2020 - 2019	L4-1.5L Híbrido	GP-149	GP-149 SNG			
-------------	-----------------	--------	------------	--	--	--

ODYSSEY

2019 - 2018	V6-3.5L	GP-149	GP-149 SNG			
2017 - 2011	V6-3.5L	GP-149	GP-149 SNG	GA-223		GAC-92
2010 - 2005	V6-3.5L	GP-149	GP-149 SNG	GA-383		GAC-92
2004 - 2002	V6-3.5L	GP-6811	GP-6811 SNG	GA-387	GG-160	
2001 - 2000	V6-3.5L	GP-6811	GP-6811 SNG	GA-183	GG-160	
1999	V6-3.5L	GP-149	GP-149 SNG			
1999	V6-3.5L	GP-149	GP-149 SNG	GA-183		

PILOT

2020 - 2016	V6-3.5L	GP-149	GP-149 SNG			GAC-92
2015 - 2009	V6-3.5L	GP-149	GP-149 SNG	GA-383		GAC-92
2008 - 2005	V6-3.5L	GP-149	GP-149 SNG	GA-385		
2004 - 2003	V6-3.5L	GP-6811	GP-6811 SNG	GA-385		

RIDGELINE

2020 - 2017	V6-3.5L	GP-149	GP-149 SNG			
2014 - 2006	V6-3.5L	GP-149	GP-149 SNG			GAC-92

HUMMER

H2

2009 - 2008	V8-6.2L	GP-406	GP-406 SNG			
2007	V8-6.0L	GP-406	GP-406 SNG			
2006	V8-6.0L	GP-44				
2005	V8-6.0L	GP-44			GG-209	

H3

2010 - 2008	L5-3.7L	GP-3675		GA-266		
2010 - 2008	V8-5.3L	GP-406	GP-406 SNG	GA-266		
2007	L5-3.7L	GP-3675		GA-415		
2006	L5-3.5L	GP-3675		GA-415		

H3T

2010 - 2009	L5-3.7L	GP-3675		GA-266		
-------------	---------	---------	--	--------	--	--

HYUNDAI

ACCENT

2021	L4-1.6L					GAC-2332
2020 - 2018	L4-1.6L	GP-6811	GP-6811 SNG	GA-1618 ⁽¹⁾		
2017 - 2012	L4-1.6L	GP-6811	GP-6811 SNG	GA-365		
2011 - 2006	L4-1.6L	GP-6811	GP-6811 SNG	GA-363		
2005 - 2001	L4-1.6L	GP-6811	GP-6811 SNG	GA-216		
2002 - 2000	L4-1.5L	GP-6811	GP-6811 SNG	GA-216		
1999 - 1995	L4-1.5L	GP-149	GP-149 SNG	GA-476	GG-114	

(1) Nuevo

Los filtros Gonher prolongan la vida útil del motor evitando el desgaste prematuro.
Para vehículos anteriores a 1990, consulte nuestro catálogo web en www.grupogonher.com

GONHER.		ACEITE	SINTÉTICO	AIRE	COMB.	CABINA
AÑO	MOTOR					

HYUNDAI (Continúa)

AZERA

2008 - 2007	V6-3.3L					GAC-60
2008 - 2006	V6-3.8L					GAC-60

CRETA

2020 - 2017	L4-1.6L	GP-6811	GP-6811 SNG	GA-889		
-------------	---------	---------	-------------	--------	--	--

ELANTRA

2021	L4-2.0L			GA-2218		
2020 - 2019	L4-2.0L	GP-6811	GP-6811 SNG	GA-2218		GAC-2332 ⁽¹⁾
2020 - 2017	L4-1.4L Turbo	GP-6811	GP-6811 SNG	GA-2218 ⁽¹⁾		GAC-2332 ⁽¹⁾
2020 - 2017	L4-1.6L Turbo	GP-6811	GP-6811 SNG	GA-2218 ⁽¹⁾		GAC-2332 ⁽¹⁾
2018 - 2017	L4-2.0L	GP-6811	GP-6811 SNG	GA-2218 ⁽¹⁾		GAC-2332 ⁽¹⁾
2016 - 2014	L4-2.0L	GP-6811	GP-6811 SNG			
2016 - 2013	L4-1.8L	GP-6811	GP-6811 SNG			
2012 - 2011	L4-1.8L	GP-149	GP-149 SNG			
2012 - 2007	L4-2.0L	GP-6811	GP-6811 SNG			
2006 - 2001	L4-2.0L	GP-6811	GP-6811 SNG	GA-9392		
2000 - 1999	L4-2.0L	GP-6811	GP-6811 SNG		GG-8160	
1998 - 1996	L4-1.8L	GP-149	GP-149 SNG		GG-8160	
1995	L4-1.6L	GP-149	GP-149 SNG	GA-362	GG-8160	
1995	L4-1.8L	GP-149	GP-149 SNG	GA-362		
1994 - 1993	L4-1.6L	GP-149	GP-149 SNG	GA-362	GG-7196	
1994 - 1993	L4-1.8L	GP-149	GP-149 SNG	GA-362	GG-7196	
1992	L4-1.6L	GP-40		GA-362	GG-7196	

ELANTRA COUPE

2014	L4-2.0L	GP-6811	GP-6811 SNG			
2013	L4-1.8L	GP-6811	GP-6811 SNG			

ELANTRA GT

2019 - 2018	L4-1.6L Turbo	GP-6811	GP-6811 SNG			
2016 - 2014	L4-2.0L	GP-6811	GP-6811 SNG			
2013	L4-1.8L	GP-6811	GP-6811 SNG			

EXCEL

1994 - 1993	L4-1.5L	GP-149	GP-149 SNG	GA-362		
1992	L4-1.5L	GP-40		GA-362		
1991 - 1990	L4-1.5L	GP-40		GA-78, GA-362	GG-196	

GENESIS COUPE

2014 - 2010	L4-2.0L Turbo	GP-6811	GP-6811 SNG			
-------------	---------------	---------	-------------	--	--	--

GRAND I10

2019	L4-1.2L	GP-149	GP-149 SNG	GA-368		
2018	L4-1.2L	GP-149	GP-149 SNG	GA-368		GAC-2277 ⁽¹⁾
2017 - 2015	L4-1.3L	GP-149	GP-149 SNG	GA-368		

IONIQ

2020 - 2017	L4-1.6L Híbrido	GP-6811	GP-6811 SNG			
-------------	-----------------	---------	-------------	--	--	--





IX35

2015	L4-2.0L	GP-6811	GP-6811 SNG	GA-889		
------	---------	---------	-------------	--------	--	--

KONA

2019 - 2018	L4-1.6L Turbo	GP-6811	GP-6811 SNG			
2019 - 2018	L4-2.0L	GP-6811	GP-6811 SNG			

(1) Nuevo

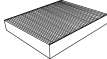
GONHER		ACEITE	SINTÉTICO	AIRE	COMB.	CABINA
AÑO	MOTOR					

HYUNDAI (Continúa)

PALISADE

2020	V6-3.8L			GA-8113 ⁽¹⁾		
------	---------	--	--	------------------------	--	--

SANTA FE

2020 - 2019	L4-2.0L Turbo	GP-6811	GP-6811 SNG	GA-8113 ⁽¹⁾		
2020 - 2019	L4-2.4L	GP-6811	GP-6811 SNG	GA-8113 ⁽¹⁾		
2018 - 2015	V6-3.3L	GP-6811	GP-6811 SNG			
2012 - 2010	L4-2.4L	GP-6811	GP-6811 SNG			
2009 - 2007	V6-3.3L					GAC-60
2009 - 2006	V6-2.7L	GP-6811	GP-6811 SNG			GAC-60
2006 - 2003	V6-3.5L	GP-149	GP-149 SNG			
2005 - 2001	V6-2.7L	GP-6811	GP-6811 SNG			
2004 - 2001	L4-2.4L	GP-6811	GP-6811 SNG			GAC-2287 ⁽¹⁾

SANTA FE SPORT

2018 - 2017	L4-2.0L Turbo	GP-6811	GP-6811 SNG	GA-8113 ⁽¹⁾		
2018 - 2017	L4-2.4L	GP-6811	GP-6811 SNG	GA-8113 ⁽¹⁾		
2018 - 2013	L4-2.0L Turbo	GP-6811	GP-6811 SNG			
2016 - 2013	L4-2.4L	GP-6811	GP-6811 SNG			

SANTA FE XL

2019	V6-3.3L	GP-6811	GP-6811 SNG			
------	---------	---------	-------------	--	--	--

SCOUPE

1995 - 1993	L4-1.5L	GP-149	GP-149 SNG	GA-362	GG-7196	
1995 - 1993	L4-1.5L Turbo	GP-149	GP-149 SNG		GG-114	
1992 - 1991	L4-1.5L	GP-40		GA-362	GG-7196	





SONATA

2020	L4-1.6L Turbo	GP-6811	GP-6811 SNG			
2019	L4-2.0L Turbo	GP-6811	GP-6811 SNG			
2019	L4-2.4L	GP-6811	GP-6811 SNG			
2018 - 2016	L4-2.0L Híbrido	GP-6811	GP-6811 SNG			
2018 - 2016	L4-2.0L Turbo	GP-6811	GP-6811 SNG	GA-2221 ⁽¹⁾		
2018 - 2015	L4-1.6L Turbo	GP-6811	GP-6811 SNG			
2018 - 2015	L4-2.4L	GP-6811	GP-6811 SNG	GA-2221 ⁽¹⁾		
2015 - 2011	L4-2.0L Turbo	GP-6811	GP-6811 SNG			
2015 - 2011	L4-2.4L Híbrido	GP-6811	GP-6811 SNG			
2014 - 2011	L4-2.4L	GP-6811	GP-6811 SNG			
2010 - 2006	L4-2.4L	GP-6811	GP-6811 SNG			GAC-60
2010 - 2006	V6-3.3L					GAC-60
2008	L4-2.4L					GAC-60
2005 - 2003	L4-2.4L	GP-6811	GP-6811 SNG	GA-491		
2005 - 2002	V6-2.7L	GP-6811	GP-6811 SNG	GA-491	GG-187	
2002 - 1999	L4-2.4L	GP-6811	GP-6811 SNG	GA-491	GG-187	
2001 - 1999	V6-2.5L	GP-6811	GP-6811 SNG	GA-491	GG-187	
1998 - 1994	L4-2.0L	GP-149	GP-149 SNG	GA-362	GG-187	
1998 - 1994	V6-3.0L	GP-149	GP-149 SNG	GA-362	GG-187	
1993 - 1990	V6-3.0L	GP-149	GP-149 SNG	GA-362	GG-7196	
1993	L4-2.0L	GP-149	GP-149 SNG	GA-362	GG-223	
1992	L4-2.0L	GP-40		GA-362	GG-7196	
1991 - 1990	L4-2.4L	GP-40		GA-362	GG-7196	

STAREX

2020 - 2019	L4-2.4L			GA-115		
-------------	---------	--	--	--------	--	--

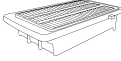
(1) Nuevo

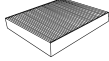
GONHER.		ACEITE	SINTÉTICO	AIRE	COMB.	CABINA
AÑO	MOTOR					

HYUNDAI (Continúa)

TIBURON

2008 - 2004	L4-2.0L	GP-6811	GP-6811 SNG	GA-9392		
2008 - 2004	V6-2.7L	GP-6811	GP-6811 SNG	GA-9392		
2003	L4-2.0L	GP-149	GP-149 SNG	GA-9392		
2003	V6-2.7L	GP-149	GP-149 SNG	GA-9392		
2001 - 1999	L4-2.0L	GP-6811	GP-6811 SNG		GG-8160	
1998 - 1997	L4-2.0L	GP-149	GP-149 SNG		GG-8160	
1997	L4-1.8L	GP-149	GP-149 SNG		GG-8160	

TUCSON

2020 - 2019	L4-2.0L	GP-6811	GP-6811 SNG			
2020 - 2019	L4-2.4L	GP-6811	GP-6811 SNG	GA-1033 ⁽¹⁾		GAC-2296 ⁽¹⁾
2020 - 2016	L4-2.0L	GP-6811	GP-6811 SNG	GA-1033 ⁽¹⁾		GAC-2296 ⁽¹⁾
2018 - 2016	L4-1.6L Turbo	GP-6811	GP-6811 SNG	GA-1033 ⁽¹⁾		
2018	L4-2.4L			GA-1033 ⁽¹⁾		
2015 - 2011	L4-2.0L	GP-6811	GP-6811 SNG			
2015 - 2010	L4-2.4L	GP-6811	GP-6811 SNG			
2009 - 2005	L4-2.0L	GP-6811	GP-6811 SNG	GA-308		
2009 - 2005	V6-2.7L	GP-6811	GP-6811 SNG	GA-308		

VELOSTER

2019	L4-1.6L Turbo	GP-6811	GP-6811 SNG	GA-365		
2017 - 2013	L4-1.6L Turbo	GP-6811	GP-6811 SNG	GA-365		
2017 - 2012	L4-1.6L	GP-6811	GP-6811 SNG	GA-365		

XG300

2001	V6-3.0L	GP-6811	GP-6811 SNG		GG-187	
------	---------	---------	-------------	--	--------	--

XG350

2005 - 2002	V6-3.5L	GP-149	GP-149 SNG			
-------------	---------	--------	------------	--	--	--

INFINITI

FX35

2012	V6-3.5L	GP-91	GP-91 SNG	GAD-117		
------	---------	-------	-----------	---------	--	--

FX37

2013	V6-3.7L	GP-91	GP-91 SNG	GAD-117		
------	---------	-------	-----------	---------	--	--

FX50

2013 - 2012	V8-5.0L	GP-149	GP-149 SNG	GAD-117		
-------------	---------	--------	------------	---------	--	--

G37

2013 - 2012	V6-3.7L	GP-91	GP-91 SNG			
-------------	---------	-------	-----------	--	--	--

I30

2001 - 1998	V6-3.0L	GP-149	GP-149 SNG	GAD-15	GG-63	
-------------	---------	--------	------------	--------	-------	--

I35

2003	V6-3.5L	GP-149	GP-149 SNG	GAD-15		
2002	V6-3.5L	GP-91	GP-91 SNG	GAD-15		

JX35

2013	V6-3.5L	GP-91	GP-91 SNG	GAD-15		
------	---------	-------	-----------	--------	--	--





M37

2013 - 2012	V6-3.7L	GP-91	GP-91 SNG			
-------------	---------	-------	-----------	--	--	--

M56

2013 - 2012	V8-5.6L	GP-149	GP-149 SNG	GAD-117		
-------------	---------	--------	------------	---------	--	--

(1) Nuevo

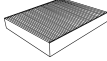
GONHER		ACEITE	SINTÉTICO	AIRE	COMB.	CABINA
AÑO	MOTOR					

INFINITI (Continúa)

Q40

2015	V6-3.7L	GP-6811	GP-6811 SNG			
------	---------	---------	-------------	--	--	--

Q45

2006	V8-4.5L	GP-149	GP-149 SNG	GAD-129	GG-63	
2005	V8-4.5L	GP-149	GP-149 SNG	GAD-129		
2004-2002	V8-4.5L	GP-149	GP-149 SNG	GAD-129	GG-63	
2001-1998	V8-4.1L	GP-149	GP-149 SNG	GAD-129		
1997	V8-4.1L	GP-149	GP-149 SNG	GAD-129	GG-63	
1995-1994	V8-4.5L	GP-37		GAD-129	GG-63	

Q50

2019 - 2017	V6-3.0L Turbo	GP-91	GP-91 SNG	GAD-117		
2019 - 2015	V6-3.5L Híbrido	GP-91	GP-91 SNG	GAD-116		
2016 - 2015	V6-3.7L	GP-91	GP-91 SNG	GAD-116		

Q60

2019 - 2017	V6-3.0L Turbo	GP-91	GP-91 SNG	GAD-117		
2015 - 2014	V6-3.7L	GP-91	GP-91 SNG			

Q70

2019 - 2016	V6-3.7L	GP-91	GP-91 SNG			
2019 - 2016	V8-5.6L	GP-149	GP-149 SNG	GAD-117		
2014	V6-3.7L	GP-91	GP-91 SNG	GAD-117		
2014	V8-5.6L	GP-149	GP-149 SNG	GAD-117		

QX50

2019	L4-2.0L Turbo	GP-91	GP-91 SNG			
------	---------------	-------	-----------	--	--	--

QX56

2013 - 2012	V8-5.6L	GP-149	GP-149 SNG			
2009	V8-5.6L	GP-149	GP-149 SNG			

QX60

2019 - 2014	V6-3.5L	GP-91	GP-91 SNG	GAD-15		
2019	L4-2.5L Híbrido	GP-91	GP-91 SNG			
2018	L4-2.5L Híbrido	GP-91	GP-91 SNG	GAD-15		
2017 - 2015	L4-2.5L Híbrido	GP-91	GP-91 SNG			

QX70

2017 - 2014	V6-3.7L	GP-91	GP-91 SNG	GAD-117		
2014	V8-5.0L	GP-149	GP-149 SNG	GAD-117		

QX80

2019 - 2015	V8-5.6L	GP-149	GP-149 SNG			
2014	V8-5.6L	GP-149	GP-149 SNG	GAD-117		

ISUZU

ASCENDER





2008-2003	L6-4.2L				GG-209	
2006-2003	V8-5.3L				GG-209	

ELF 200

2019 - 2015	L4-3.0L Turbo diésel	G-3753				
-------------	----------------------	--------	--	--	--	--

ELF 300

2019 - 2015	L4-3.0L Turbo diésel	G-3753				
-------------	----------------------	--------	--	--	--	--

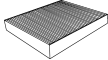
GONHER.		ACEITE	SINTÉTICO	AIRE	COMB.	CABINA
AÑO	MOTOR					
JAC						

J4

2020 - 2018	L4-1.5L	GP-6811	GP-6811 SNG			
-------------	---------	---------	-------------	--	--	--

SEI 2

2020 - 2017	L4-1.5L	GP-6811	GP-6811 SNG			
-------------	---------	---------	-------------	--	--	--

SEI 3

2020 - 2017	L4-1.6L	GP-6811	GP-6811 SNG			
-------------	---------	---------	-------------	--	--	--

JAGUAR

S-TYPE

2008-2006	V6-3.0L	GP-454			GG-986	
2008-2003	V8-4.2L	GP-457			GG-986	
2005-2004	V6-3.0L	GP-3600	GP-3600 SNG		GG-986	
2003-2001	V6-3.0L	GP-3600	GP-3600 SNG	GA-479	GG-986	
2002	V8-4.0L	GP-457		GA-479	GG-986	
2001-2000	V8-4.0L	GP-457		GA-479	GG-46	
1999	V8-4.0L	GP-457		GA-479		

VANDEN PLAS

2009	V8-4.2L	GP-457				
2007	V8-4.2L	GP-457				
2006	V8-4.2L			GA-2130		
2005-2004	V8-4.2L	GP-457				
2003-1998	V8-4.0L	GP-457		GA-2130	GG-46	

XE

2017	L4-2.0L Turbo	GP-58	GP-58 SNG			
------	---------------	-------	-----------	--	--	--

XF

2015 - 2013	L4-2.0L Turbo	GP-58	GP-58 SNG			
2010	V8-4.2L	GP-457				
2009	V8-4.2L	GP-457			GG-986	

XJ8

2009	V8-4.2L	GP-457			GG-986	
2008-2007	V8-4.2L	GP-457			GG-46	
2005	V8-4.2L	GP-457				
2003-1998	V8-4.0L	GP-457		GA-2130	GG-46	

XJR





2009	V8-4.2L	GP-457			GG-986	
2008-2007	V8-4.2L	GP-457			GG-46	
2005	V8-4.2L	GP-457				
2004	V8-4.2L	GP-457			GG-46	
2003-1999	V8-4.0L	GP-457		GA-2130	GG-46	

XK

2007	V8-4.2L	GP-457				
------	---------	--------	--	--	--	--

XK8

2004	V8-4.2L	GP-457			GG-46	
2003	V8-4.2L	GP-457		GA-2130	GG-46	
2002-2000	V8-4.0L	GP-457		GA-2130	GG-46	
1998	V8-4.0L	GP-457		GA-2130	GG-46	

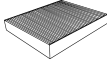
GONHER		ACEITE	SINTÉTICO	AIRE	COMB.	CABINA
AÑO	MOTOR					

JAGUAR (Continúa)

XKR

2012	V8-5.0L	GP-457				
2009-2008	V8-4.2L	GP-457				
2006	V8-4.2L			GA-2130		
2005	V8-4.2L	GP-457		GA-2130		
2004	V8-4.2L	GP-457			GG-46	
2003	V8-4.2L	GP-457		GA-2130	GG-46	
2002-2000	V8-4.0L	GP-457		GA-2130	GG-46	

X-TYPE

2008-2006	V6-3.0L	GP-454				
2005-2002	V6-2.5L	GP-454			GG-64	
2005-2002	V6-3.0L	GP-454			GG-64	
2001	V6-3.0L	GP-454				

JEEP

CHEROKEE

2019	V6-3.2L	G-349				
2018 - 2014	V6-3.2L	G-349		GA-2378		
2017 - 2014	L4-2.4L	GP-406	GP-406 SNG	GA-2378		
2001 - 1993	L6-4.0L	GP-81	GP-81 SNG	GA-3901	GG-79	
2001	L6-4.0L	GP-81	GP-81 SNG	GA-300	GG-283	
2000 - 1998	L6-4.0L	GP-81	GP-81 SNG	GA-3901	GG-283	
1997	L4-2.5L	GP-81	GP-81 SNG	GA-3901		
1996 - 1990	L4-2.5L				GG-79	
1996 - 1990	L6-4.0L				GG-79	
1995	L4-2.5L	GP-81	GP-81 SNG	GA-3901	GG-79	

COMANCHE

1992 - 1990	L4-2.5L				GG-79	
1992 - 1990	L6-4.0L				GG-79	

COMMANDER

2010 - 2008	V8-5.7L	GP-68	GP-68 SNG	GA-477		
2008 - 2006	V8-4.7L	GP-81	GP-81 SNG	GA-477		
2007 - 2006	V8-5.7L	GP-81	GP-81 SNG	GA-477		

COMPASS





2019 - 2018	L4-2.4L	GP-406	GP-406 SNG			GAC-50
2017 - 2012	L4-2.4L	GP-406	GP-406 SNG	GA-220R		GAC-50
2010 - 2007	L4-2.4L	GP-406	GP-406 SNG	GA-489		GAC-50
2009	L4-2.0L					GAC-50
2007	L4-2.0L					GAC-50

GRAND CHEROKEE

2020 - 2018	V8-5.7L	GP-406	GP-406 SNG	GA-478		
2020 - 2018	V8-6.2L					GAC-2282 ⁽¹⁾
2019	V6-3.6L	G-349				
2019	V8-6.2L	GP-68	GP-68 SNG			GAC-2282 ⁽¹⁾
2019	V8-6.4L	GP-68	GP-68 SNG			
2018 - 2016	V8-5.7L	GP-406	GP-406 SNG	GA-478		GAC-2282 ⁽¹⁾
2018	V6-3.6L	G-349				GAC-2282 ⁽¹⁾
2018	V8-6.4L	GP-68	GP-68 SNG			GAC-2282 ⁽¹⁾
2017 - 2014	V6-3.6L	G-349		GA-478		GAC-2282 ⁽¹⁾
2017	V8-6.4L	GP-68	GP-68 SNG	GA-478		GAC-2282 ⁽¹⁾
2015 - 2012	V8-6.4L	GP-68	GP-68 SNG	GA-478		GAC-2282 ⁽¹⁾
2015 - 2011	V8-5.7L	GP-68	GP-68 SNG	GA-478		GAC-2282 ⁽¹⁾

(1) Nuevo

Los filtros Gonher prolongan la vida útil del motor evitando el desgaste prematuro.
Para vehículos anteriores a 1990, consulte nuestro catálogo web en www.grupogonher.com

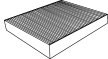
GONHER.		ACEITE	SINTÉTICO	AIRE	COMB.	CABINA
AÑO	MOTOR					

JEEP (Continúa)

GRAND CHEROKEE (Continúa)

2013 - 2011	V6-3.6L	G-3744		GA-478		GAC-2282 ⁽¹⁾
2010 - 2009	V6-3.7L	GP-405	GP-405 SNG	GA-477		
2010 - 2009	V8-4.7L	GP-68	GP-68 SNG	GA-477		
2010 - 2009	V8-5.7L	GP-68	GP-68 SNG	GA-477		
2010 - 2009	V8-6.1L	GP-68	GP-68 SNG	GA-477		
2010	V6-3.0L Turbo diésel			GA-477		
2009	V8-4.7L	GP-68	GP-68 SNG	GA-300		
2008-2006	V8-6.1L	GP-81	GP-81 SNG	GA-477		
2008-2005	V6-3.7L	GP-3600	GP-3600 SNG	GA-477		
2008-2005	V8-5.7L	GP-81	GP-81 SNG	GA-477		
2008	V8-4.7L	GP-58	GP-58 SNG	GA-477		
2007-2005	V8-4.7L	GP-81	GP-81 SNG	GA-477	GG-283	
2007	V8-4.7L	GP-81	GP-81 SNG	GA-300	GG-283	
2007	V8-4.7L	GP-81	GP-81 SNG	GA-477		
2004-2002	V8-4.7L	GP-81	GP-81 SNG	GA-448	GG-283	
2004-1993	L6-4.0L	GP-81	GP-81 SNG	GA-300	GG-99	
2001-1999	V8-4.7L	GP-81	GP-81 SNG	GA-300	GG-283	
2000-1999	L6-4.0L	GP-81	GP-81 SNG	GA-300	GG-283	
1998	V8-5.2L	GP-81	GP-81 SNG	GA-300	GG-243	
1998	V8-5.9L	GP-81	GP-81 SNG	GA-300		
1997-1995	V8-5.2L	GP-81	GP-81 SNG	GA-300	GG-99	
1994-1993	V8-5.2L	GP-81	GP-81 SNG	GA-300	GG-243	
1994	L6-4.0L	GP-81	GP-81 SNG	GA-300	GG-243	

GRAND WAGONEER

1993	V8-5.2L	GP-81	GP-81 SNG	GA-300	GG-99	
------	---------	-------	-----------	--------	-------	--

LIBERTY

2013-2009	V6-3.7L	GP-405	GP-405 SNG	GA-143		
2008	V6-3.7L	GP-3600	GP-3600 SNG	GA-143		
2007-2002	V6-3.7L	GP-3600	GP-3600 SNG	GA-477	GG-97	
2006-2005	L4-2.8L Turbo diésel	GP-128				
2005	L4-2.4L	GP-58	GP-58 SNG	GA-443		

PATRIOT

2017-2011	L4-2.4L	GP-406	GP-406 SNG	GA-220R		GAC-50
2010-2007	L4-2.4L	GP-406	GP-406 SNG	GA-489		GAC-50
2009-2007	L4-2.0L					GAC-50





RENEGADE

2020-2017	L4-1.8L	G-446				
-----------	---------	-------	--	--	--	--

WRANGLER

2019	V6-3.6L	G-349				
2017-2014	V6-3.6L	G-349		GA-4018		
2013-2012	V6-3.6L	G-3744		GA-4018		
2011-2007	V6-3.8L	GP-58	GP-58 SNG	GA-4018		
2006-2003	L4-2.4L	GP-58	GP-58 SNG	GA-443		
2006-1997	L6-4.0L	GP-81	GP-81 SNG	GA-301		
2002-1997	L4-2.5L	GP-81	GP-81 SNG	GA-301	GG-79	
1995-1993	L4-2.5L	GP-81	GP-81 SNG	GAVW-2	GG-79	
1995-1993	L6-4.0L	GP-81	GP-81 SNG	GA-301		

(1) Nuevo

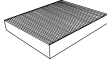
GONHER		ACEITE	SINTÉTICO	AIRE	COMB.	CABINA
AÑO	MOTOR					

JEEP (Continúa)

WRANGLER JK

2018	V6-3.6L	G-349		GA-4018		
------	---------	-------	--	---------	--	--

KIA

AMANTI

2006-2004	V6-3.5L	GP-149	GP-149 SNG			
-----------	---------	--------	------------	--	--	--

FORTE

2021	L4-1.6L Turbo			GA-2218		
2021	L4-2.0L			GA-2218		
2020-2019	L4-2.0L	GP-6811	GP-6811 SNG	GA-2218 ⁽¹⁾		GAC-2332
2020	L4-1.6L Turbo			GA-2218 ⁽¹⁾		GAC-2332
2020	L4-1.6L Turbo			GA-2218		GAC-2332
2019	L4-1.6L Turbo			GA-2218 ⁽¹⁾		GAC-2332
2018-2016	L4-2.0L	GP-6811	GP-6811 SNG	GA-889		
2010	L4-2.0L	GP-6811	GP-6811 SNG			

FORTE KOUP

2016	L4-1.6L Turbo	GP-6811	GP-6811 SNG			
2016	L4-2.0L	GP-6811	GP-6811 SNG			

FORTE5

2018-2015	L4-1.6L Turbo	GP-6811	GP-6811 SNG			
2018-2015	L4-2.0L	GP-6811	GP-6811 SNG			

NIRO

2020-2017	L4-1.6L Híbrido	GP-6811	GP-6811 SNG			
-----------	-----------------	---------	-------------	--	--	--

OPTIMA

2020-2019	L4-2.0L Turbo	GP-6811	GP-6811 SNG	GA-2221 ⁽¹⁾		
2019-2013	L4-2.4L	GP-6811	GP-6811 SNG			
2018-2011	L4-2.0L Turbo	GP-6811	GP-6811 SNG			
2015-2011	L4-2.4L Híbrido	GP-6811	GP-6811 SNG			
2012-2011	L4-2.4L	GP-6811	GP-6811 SNG	GA-149		
2010-2006	L4-2.4L	GP-6811	GP-6811 SNG	GA-149		GAC-60
2010-2006	V6-2.7L	GP-6811	GP-6811 SNG	GA-149		GAC-60
2005	L4-2.4L	GP-6811	GP-6811 SNG	GA-491		
2005	V6-2.7L	GP-6811	GP-6811 SNG	GA-491		
2004-2002	V6-2.7L	GP-6811	GP-6811 SNG	GA-491	GG-187	
2004-2001	L4-2.4L	GP-6811	GP-6811 SNG	GA-491	GG-187	
2001	V6-2.5L	GP-6811	GP-6811 SNG	GA-491	GG-187	

RIO

2020-2018	L4-1.6L	GP-6811	GP-6811 SNG	GA-1618 ⁽¹⁾		GA-2332
2017-2012	L4-1.6L	GP-6811	GP-6811 SNG	GA-365		
2011-2006	L4-1.6L	GP-6811	GP-6811 SNG	GA-363		

RIO5

2011-2006	L4-1.6L	GP-6811	GP-6811 SNG	GA-363		
-----------	---------	---------	-------------	--------	--	--

RONDO





2010-2007	L4-2.4L	GP-6811	GP-6811 SNG	GA-149		
2010-2007	V6-2.7L	GP-6811	GP-6811 SNG	GA-149		

SEDONA

2020-2015	V6-3.3L			GA-8113 ⁽¹⁾		
2006	V6-3.8L	GP-6811	GP-6811 SNG			
2005-2002	V6-3.5L	GP-149	GP-149 SNG			

(1) Nuevo

Los filtros Gonher prolongan la vida útil del motor evitando el desgaste prematuro.
Para vehículos anteriores a 1990, consulte nuestro catálogo web en www.grupogonher.com

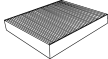
GONHER		ACEITE	SINTÉTICO	AIRE	COMB.	CABINA
AÑO	MOTOR					

KIA (Continúa)

SELTOS

2020	L4-1.6L	GP-6811		GA-1033		GAC-2296
------	---------	---------	--	---------	--	----------

SEPHIA

2001 - 1999	L4-1.8L	GP-91	GP-91 SNG	GA-304		
1998	L4-1.8L	GP-91	GP-91 SNG			
1997 - 1995	L4-1.8L	GP-91	GP-91 SNG		GG-150	
1997 - 1994	L4-1.6L	GP-91	GP-91 SNG		GG-150	

SORENTO

2020 - 2016	L4-2.4L	GP-6811	GP-6811 SNG	GA-8113 ⁽¹⁾		
2020 - 2016	V6-3.3L	GP-6811	GP-6811 SNG	GA-8113 ⁽¹⁾		
2018 - 2016	L4-2.0L Turbo	GP-6811	GP-6811 SNG	GA-8113 ⁽¹⁾		
2016	L4-2.0L	GP-6811	GP-6811 SNG	GA-8113 ⁽¹⁾		
2015 - 2011	L4-2.4L	GP-6811	GP-6811 SNG			
2006	V6-3.5L	GP-149	GP-149 SNG			
2004 - 2003	V6-3.5L	GP-149	GP-149 SNG			

SOUL

2020	L4-1.6L			GA-2218		
2020	L4-1.6L	GP-6811	GP-6811 SNG	GA-2218 ⁽¹⁾		GAC-2296 ⁽¹⁾
2020	L4-2.0L	GP-6811		GA-2218 ⁽¹⁾		GAC-2296 ⁽¹⁾
2019 - 2018	L4-1.6L Turbo	GP-6811	GP-6811 SNG	GA-365		
2019 - 2012	L4-1.6L	GP-6811	GP-6811 SNG	GA-365		
2019 - 2012	L4-2.0L	GP-6811	GP-6811 SNG	GA-365		
2011 - 2010	L4-1.6L	GP-6811	GP-6811 SNG			
2011 - 2010	L4-2.0L	GP-6811	GP-6811 SNG			

SPECTRA

2009 - 2004	L4-2.0L	GP-6811	GP-6811 SNG	GA-9392		
2004	L4-1.8L	GP-6811	GP-6811 SNG	GA-9392		
2003	L4-1.8L	GP-6811	GP-6811 SNG	GA-304		
2002 - 2000	L4-1.8L	GP-91	GP-91 SNG	GA-304		

SPECTRA5

2009 - 2005	L4-2.0L	GP-6811	GP-6811 SNG	GA-9392		
-------------	---------	---------	-------------	---------	--	--

SPORTAGE

2020 - 2017	L4-2.0L	GP-6811	GP-6811 SNG	GA-1033 ⁽¹⁾		GAC-2296 ⁽¹⁾
2020 - 2017	L4-2.4L	GP-6811	GP-6811 SNG	GA-1033 ⁽¹⁾		GAC-2296 ⁽¹⁾
2016	L4-2.0L	GP-6811	GP-6811 SNG	GA-1033 ⁽¹⁾		
2015 - 2011	L4-2.0L Turbo	GP-6811	GP-6811 SNG			
2015 - 2011	L4-2.4L	GP-6811	GP-6811 SNG			
2010 - 2005	L4-2.0L	GP-6811	GP-6811 SNG	GA-308		
2010 - 2005	V6-2.7L	GP-6811	GP-6811 SNG	GA-308		
2002 - 1995	L4-2.0L			GA-8121		

STINGER

2020 - 2018	L4-2.0L Turbo	GP-6811	GP-6811 SNG			
-------------	---------------	---------	-------------	--	--	--

TELLURIDE

2020	V6-3.8L			GA-8113 ⁽¹⁾		
------	---------	--	--	------------------------	--	--





LAND ROVER

DISCOVERY

2004 - 2003	V8-4.6L	GP-81	GP-81 SNG	GA-2146	GG-46	
2002 - 2000	V8-4.0L	GP-432		GA-2146	GG-46	
1999	V8-4.0L	GP-81	GP-81 SNG	GA-2146	GG-46	

(1) Nuevo

Los filtros Gonher prolongan la vida útil del motor evitando el desgaste prematuro.
Para vehículos anteriores a 1990, consulte nuestro catálogo web en www.grupogonher.com

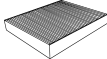
GONHER		ACEITE	SINTÉTICO	AIRE	COMB.	CABINA
AÑO	MOTOR					

FILTROS

LAND ROVER

LAND ROVER (Continúa)

DISCOVERY (Continúa)

1998 - 1997	V8-4.0L	GP-81	GP-81 SNG		GG-46	
-------------	---------	-------	-----------	--	-------	--

DISCOVERY SPORT

2017 - 2015	L4-2.0L Turbo	GP-58	GP-58 SNG			
-------------	---------------	-------	-----------	--	--	--

FREELANDER

2006 - 2001	V6-2.5L	GP-455		GA-2146		
2001 - 1999	L4-1.8L	GP-455		GA-2174		

LR2

2015	L4-2.0L Turbo	GP-58	GP-58 SNG			
2013	L4-2.0L	GP-58	GP-58 SNG			
2013	L4-2.0L Turbo	GP-58	GP-58 SNG			

LR3

2008 - 2005	V8-4.4L	GP-457				
-------------	---------	--------	--	--	--	--

RANGE ROVER

2016 - 2014	V6-3.0L					GAC-19
2016 - 2014	V8-5.0L					GAC-19
2009 - 2008	V8-4.2L	GP-457		GAVW-616		
2009 - 2008	V8-4.4L	GP-457		GAVW-616		
2007 - 2006	V8-4.2L	GP-457				
2007 - 2006	V8-4.4L	GP-457				
2005 - 2003	V8-4.4L	G-984				
2001 - 1997	V8-4.6L	GP-432		GA-2146	GG-46	

RANGE ROVER EVOQUE

2018 - 2016	L4-2.0L Turbo	GP-58	GP-58 SNG			
2014 - 2012	L4-2.0L	GP-58	GP-58 SNG			
2014 - 2012	L4-2.0L Turbo	GP-58	GP-58 SNG			

RANGE ROVER SPORT

2009 - 2006	V8-4.2L	GP-457				
2009 - 2006	V8-4.4L	GP-457				

LEXUS

CT200H

2017 - 2011	L4-1.8L Híbrido					GAC-19
-------------	-----------------	--	--	--	--	--------

ES300

1995	V6-3.0L			GA-476		
------	---------	--	--	--------	--	--

ES300H

2017 - 2013	L4-2.5L Híbrido					GAC-19
-------------	-----------------	--	--	--	--	--------

ES330

2006 - 2004	V6-3.3L					GAC-2294 ⁽¹⁾
-------------	---------	--	--	--	--	-------------------------

ES350

2020 - 2019	V6-3.5L			GA-2317		
2017 - 2007	V6-3.5L					GAC-19





GX470

2009 - 2006	V8-4.7L					GAC-2294 ⁽¹⁾
-------------	---------	--	--	--	--	-------------------------

RX350

2009 - 2008	V6-3.5L					GAC-2294 ⁽¹⁾
-------------	---------	--	--	--	--	-------------------------

(1) Nuevo

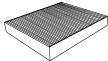
GONHER		ACEITE 	SINTÉTICO 	AIRE 	COMB. 	CABINA 
AÑO	MOTOR					

LEXUS (Continúa)

RX400H

2008 - 2006	V6-3.3L Híbrido					GAC-2294 ⁽¹⁾
-------------	-----------------	--	--	--	--	-------------------------

LINCOLN

AVIATOR

2005	V8-4.6L	GP-68	GP-68 SNG	GA-395	GG-101	
2004-2003	V8-4.6L	GP-68	GP-68 SNG	GA-395		

BLACKWOOD

2003-2002	V8-5.4L	GP-68	GP-68 SNG	GA-1615	GG-986	GAC-1
-----------	---------	-------	-----------	---------	--------	-------

CONTINENTAL

2020	V6-3.0L			GA-1573		
2019	V6-3.0L Turbo			GA-1573		
2018	V6-3.0L Turbo			GA-1573	GG-101	
2002 - 1995	V8-4.6L	GP-68	GP-68 SNG	GA-1615	GG-47	
1994 - 1990	V6-3.8L			GA-176		

LS

2006-2003	V8-3.9L	GP-457		GA-479	GG-101	
2005-2000	V6-3.0L	GP-3600	GP-3600 SNG	GA-479	GG-986	
2005	V6-3.0L	GP-3600	GP-3600 SNG	GA-479	GG-101	
2002-2000	V8-3.9L	GP-457		GA-479	GG-986	

MARK LT

2010	V8-5.4L	GP-68	GP-68 SNG	GA-1617	GG-101	
2008-2007	V8-5.4L	GP-68	GP-68 SNG	GA-1617	GG-101	
2006	V8-5.4L	GP-68	GP-68 SNG	GA-1617	GG-986	

MARK VIII

1998 - 1993	V8-4.6L	GP-68	GP-68 SNG		GG-92	
-------------	---------	-------	-----------	--	-------	--

MKC

2019 - 2018	L4-2.0L Turbo	GP-58	GP-58 SNG	GA-226R		
2019 - 2015	L4-2.3L Turbo	GP-58	GP-58 SNG	GA-226R		

MKS

2014 - 2011	V6-3.5L Turbo	GP-405	GP-405 SNG	GA-1542		
2011 - 2010	V6-3.7L	GP-405	GP-405 SNG	GA-1542		
2009	V6-3.7L	GP-3600	GP-3600 SNG	GA-1542		

MKX





2018 - 2016	V6-2.7L Turbo			GA-1573	GG-101	
2015	V6-3.7L	GP-405	GP-405 SNG	GA-1573		
2014 - 2011	V6-3.7L	GP-405	GP-405 SNG	GA-1542		
2010	V6-3.5L	GP-405	GP-405 SNG	GA-1542		
2009-2007	V6-3.5L	GP-3600	GP-3600 SNG	GA-1542		

MKZ

2019 - 2018	L4-2.0L Híbrido	GP-58	GP-58 SNG			
2019 - 2013	L4-2.0L Turbo	GP-58	GP-58 SNG	GA-1573		
2018	V6-3.0L Turbo			GA-1573		
2016	V6-3.7L	GP-405	GP-405 SNG	GA-1573		
2015	V6-3.7L	GP-405	GP-405 SNG	GA-1573	GG-986	
2014 - 2013	V6-3.7L	GP-405	GP-405 SNG	GA-1573		

(1) Nuevo

Los filtros Gonher prolongan la vida útil del motor evitando el desgaste prematuro.
Para vehículos anteriores a 1990, consulte nuestro catálogo web en www.grupogonher.com

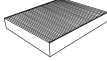
GONHER		ACEITE 	SINTÉTICO 	AIRE 	COMB. 	CABINA 
AÑO	MOTOR					

LINCOLN (Continúa)

MKZ (Continúa)

2012 - 2010	V6-3.5L	GP-405	GP-405 SNG	GA-1542		
2009-2007	V6-3.5L	GP-3600	GP-3600 SNG	GA-1542		

NAVIGATOR

2018 - 2015	V6-3.5L Turbo	GP-405	GP-405 SNG	GA-437		
2014 - 2008	V8-5.4L	GP-68	GP-68 SNG	GA-437	GG-308	
2009	V8-5.4L	GP-68	GP-68 SNG	GA-1615	GG-986	
2007	V8-5.4L	GP-68	GP-68 SNG	GA-1617	GG-986	
2006-2005	V8-5.4L	GP-68	GP-68 SNG	GA-1617	GG-986	GAC-1
2005-2004	V8-5.4L	GP-68	GP-68 SNG	GA-1615	GG-986	GAC-1
2003	V8-5.4L	GP-68	GP-68 SNG	GA-395	GG-986	GAC-1
2002 - 1998	V8-5.4L	GP-68	GP-68 SNG	GA-1615	GG-986	GAC-1

TOWN CAR

2009	V8-4.6L	GP-68	GP-68 SNG	GA-5056	GG-47	
2007-2006	V8-4.6L	GP-68	GP-68 SNG	GA-5056	GG-47	
2005 - 1998	V8-4.6L	GP-68	GP-68 SNG	GA-5056	GG-986	
1997 - 1991	V8-4.6L	GP-68	GP-68 SNG	GA-5056	GG-47	

ZEPHYR

2006	V6-3.0L	GP-68	GP-68 SNG	GA-1544		
------	---------	-------	-----------	---------	--	--

MAZDA

2

2019 - 2018	L4-1.5L	GP-91	GP-91 SNG			
2017 - 2012	L4-1.5L	GP-91	GP-91 SNG	GA-594		

3

2020 - 2014	L4-2.5L	GP-91	GP-91 SNG	GA-924		
2018	L4-2.0L	GP-91	GP-91 SNG			
2017 - 2014	L4-2.0L	GP-91	GP-91 SNG	GA-924		
2013 - 2012	L4-2.0L	GP-58	GP-58 SNG	GA-924		
2013 - 2010	L4-2.3L Turbo	GP-58	GP-58 SNG	GA-596		
2013 - 2010	L4-2.5L	GP-58	GP-58 SNG	GA-596		
2011 - 2006	L4-2.0L	GP-58	GP-58 SNG	GA-596		
2009-2008	L4-2.3L Turbo	G-70		GA-596		
2009-2006	L4-2.3L	G-70		GA-596		

323

1994 - 1990	L4-1.6L				GG-150	
-------------	---------	--	--	--	--------	--





5

2015	L4-2.5L			GA-596		
2014 - 2012	L4-2.5L	GP-58	GP-58 SNG	GA-596		
2010	L4-2.3L	GP-58	GP-58 SNG	GA-596		
2009-2006	L4-2.3L	G-70		GA-596		

6

2019	L4-2.5L	GP-91	GP-91 SNG			
2019	L4-2.5L Turbo	GP-91	GP-91 SNG			
2018 - 2014	L4-2.5L	GP-91	GP-91 SNG	GA-924		
2013 - 2010	L4-2.5L	GP-58	GP-58 SNG	GA-1572		
2013 - 2010	V6-3.7L	GP-3600	GP-3600 SNG	GA-1542		
2009	L4-2.5L	G-70		GA-1572		
2009	V6-3.7L	GP-68	GP-68 SNG	GA-1542		
2008-2003	L4-2.3L	G-70		GA-597		

Los filtros Gonher prolongan la vida útil del motor evitando el desgaste prematuro.
Para vehículos anteriores a 1990, consulte nuestro catálogo web en www.grupogonher.com

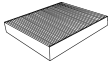
GONHER		ACEITE	SINTÉTICO	AIRE	COMB.	CABINA
AÑO	MOTOR					

MAZDA (Continúa)

6 (Continúa)

2008 - 2003	V6-3.0L	GP-68	GP-68 SNG	GA-597		
-------------	---------	-------	-----------	--------	--	--

626

2002 - 1998	V6-2.5L				GG-268	
2002	L4-2.0L				GG-268	
2001 - 1999	L4-2.0L	GP-91	GP-91 SNG		GG-268	
1998	L4-2.0L				GG-268	
1997 - 1993	L4-2.0L			GA-432	GG-268	
1997 - 1993	V6-2.5L			GA-432	GG-268	

929

1995	V6-3.0L			GA-476		
------	---------	--	--	--------	--	--

B2200

1993 - 1990	L4-2.2L				GG-115	
-------------	---------	--	--	--	--------	--

B2300

2003 - 2001	L4-2.3L				GG-210	
-------------	---------	--	--	--	--------	--

B2500

2001 - 2000	L4-2.5L				GG-210	
1999 - 1998	L4-2.5L				GG-986	

B2600

1993 - 1990	L4-2.6L				GG-115	
-------------	---------	--	--	--	--------	--

B3000

2005	V6-3.0L	GP-3600	GP-3600 SNG			
2003-2000	V6-3.0L				GG-210	
2001	V6-3.0L	GP-3600	GP-3600 SNG	GA-158	GG-210	
1999 - 1998	V6-3.0L				GG-986	

B4000

2007	V6-4.0L	GP-68	GP-68 SNG	GA-158	GG-210	
2005-2000	V6-4.0L				GG-210	
2005	V6-4.0L	GP-68	GP-68 SNG	GA-158	GG-210	
1999 - 1998	V6-4.0L				GG-986	
1997	V6-4.0L	GP-1		GA-1616	GG-1872	
1995	V6-4.0L	GP-1		GA-1616	GG-1872	

CX-3

2020 - 2016	L4-2.0L	GP-91	GP-91 SNG	GA-9530 ⁽¹⁾		
-------------	---------	-------	-----------	------------------------	--	--

CX-30

2021	L4-2.5L	GP-91				
2020	L4-2.5L	GP-91	GP-91 SNG			

CX-5





2020 - 2019	L4-2.5L Turbo	GP-91	GP-91 SNG	GA-924		
2020 - 2016	L4-2.5L	GP-91	GP-91 SNG	GA-924		
2019 - 2013	L4-2.0L	GP-91	GP-91 SNG	GA-924		
2015 - 2014	L4-2.5L	GP-91	GP-91 SNG			

CX-7

2012 - 2010	L4-2.3L Turbo	GP-58	GP-58 SNG	GA-597		GAC-2293 ⁽¹⁾
2012 - 2010	L4-2.5L	GP-58	GP-58 SNG	GA-597		GAC-2293 ⁽¹⁾
2009-2007	L4-2.3L Turbo	G-70		GA-597		GAC-2293 ⁽¹⁾

(1) Nuevo

Los filtros Gonher prolongan la vida útil del motor evitando el desgaste prematuro.
Para vehículos anteriores a 1990, consulte nuestro catálogo web en www.grupogonher.com

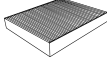
GONHER		ACEITE	SINTÉTICO	AIRE	COMB.	CABINA
AÑO	MOTOR					

MAZDA (Continúa)

CX-9

2020 - 2016	L4-2.5L Turbo	GP-91	GP-91 SNG			
2015 - 2008	V6-3.7L	GP-3600	GP-3600 SNG	GA-1542		
2007	V6-3.5L	GP-3600	GP-3600 SNG	GA-1542		

MILLENIA

1995	V6-2.3L			GA-476		
1995	V6-2.5L			GA-476		

MPV

1995 - 1990	V6-3.0L				GG-115	
1994 - 1990	L4-2.6L				GG-115	

MX-3

1995 - 1992	L4-1.6L				GG-150	
-------------	---------	--	--	--	--------	--

MX-5

2018 - 2017	L4-2.0L	GP-91	GP-91 SNG			
2016 - 2006	L4-2.0L	GP-58	GP-58 SNG			

MX-6

1997 - 1993	L4-2.0L			GA-432	GG-268	
1997 - 1993	V6-2.5L			GA-432	GG-268	

PROTEGE

2003 - 2001	L4-2.0L			GA-595		
2003	L4-2.0L Turbo			GA-595		
2001	L4-1.6L			GA-595		
2000 - 1999	L4-1.6L			GA-595	GG-150	
2000 - 1995	L4-1.8L			GA-595	GG-150	
1998 - 1995	L4-1.5L			GA-595	GG-150	
1994 - 1990	L4-1.8L				GG-150	

RX-7

1995	R2-1.3L Turbo			GA-476		
------	---------------	--	--	--------	--	--

TRIBUTE

2006	L4-2.3L	GP-58	GP-58 SNG	GA-224	GG-47	
2004 - 2001	L4-2.0L	GP-128				
2001	L4-2.0L	GP-128		GA-224	GG-47	

MERCEDES-BENZ

A160

2003 - 2002	L4-1.6L	G-910		GA-2181		
2001 - 2000	L4-1.6L	G-910		GA-2181	GG-411	

A190





2005 - 2002	L4-1.9L	G-910		GA-2181		
2001	L4-1.9L	G-910		GA-2181	GG-411	

C200

2004	L4-1.8L			GA-2109	GG-420	
2003	L4-1.8L	G-971			GG-420	

C220

1997	L4-2.2L	G-971				
1996 - 1995	L4-2.2L	G-971			GG-189	

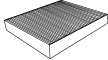
GONHER		ACEITE	SINTÉTICO	AIRE	COMB.	CABINA
AÑO	MOTOR					

MERCEDES-BENZ (Continúa)

C230

2004	L4-1.8L			GA-2109	GG-420	
2000	L4-2.3L	G-971				
1999	L4-2.3L	G-971		GA-2195	GG-251	
1998	L4-2.3L	G-971				
1997	L4-2.3L	G-971			GG-251	
1996	L4-2.3L	G-971				

C240

2002-2001	V6-2.6L	G-180		GA-2198		
-----------	---------	-------	--	---------	--	--

C250

2012	V6-3.5L			GA-2198		
------	---------	--	--	---------	--	--

C280

2009-2006	V6-3.0L	G-180		GA-2198		
2000-1999	V6-2.8L	G-180		GA-2195		
1998	L6-2.8L	G-180				
1997	L6-2.8L	G-971				
1996-1995	L6-2.8L	G-971			GG-189	

C300

2011	V6-3.0L	G-180		GA-2198		
2011	V6-3.5L	G-180		GA-2198		
2010	V6-3.0L	G-180		GA-438		
2010	V6-3.5L	G-180		GA-438		

C32 AMG

2004-2002	V6-3.2L	G-180		GA-2198	GG-420	
-----------	---------	-------	--	---------	--------	--

C320

2005-2001	V6-3.2L	G-180		GA-2198	GG-420	
-----------	---------	-------	--	---------	--------	--

C350

2014-2013	V6-3.5L			GA-2198		
2009	V6-3.5L	G-180		GA-438		
2008-2006	V6-3.5L	G-180		GA-2198		

C36 AMG

1997-1996	L6-3.6L	G-971			GG-189	
-----------	---------	-------	--	--	--------	--

C43 AMG





2000	V8-4.3L	G-180		GA-2104	GG-251	
1999	V8-4.3L	G-180				
1998	V8-4.3L	G-180		GA-2164		





C55 AMG

2007-2005	V8-5.4L	G-954		GA-4383		
-----------	---------	-------	--	---------	--	--

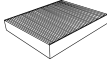
CL500

2012	V8-5.5L	G-180				
2011-2010	V8-5.5L	G-180		GA-2198		
2010	V12 5.5L Turbo			GA-438		
2009	V8-5.5L	G-180		GA-438		
2008-2007	V8-5.5L	G-180		GA-2198		
2006-2001	V8-5.0L	G-180		GA-2198	GG-420	
1999	V8-5.0L	G-180		GA-2198	GG-420	
1998	V8-5.0L	G-180		GA-2198	GG-189	
1997-1996	V8-5.0L	G-180		GA-2198		

GONHER		ACEITE	SINTÉTICO	AIRE	COMB.	CABINA
AÑO	MOTOR					
MERCEDES-BENZ (Continúa)						
CL600						
2004 - 2003	V12 5.5L Turbo	G-180				
1999	V12 6.0L			GA-2184	GG-251	
1998	V12 6.0L			GA-2184	GG-189	
CL63 AMG						
2012	V8-5.5L Turbo	G-180				
CLK320						
2005	V6-3.2L	G-180		GA-2198	GG-420	
2004	V6-3.2L	G-180		GA-2195	GG-420	
2003	V6-3.2L	G-180		GA-2198	GG-420	
2002	V6-3.2L	G-180		GA-2195	GG-420	
2001 - 1999	V6-3.2L	G-180		GA-2195		
1998	V6-3.2L	G-180				
CLK350						
2009	V6-3.5L	G-180		GA-438		
2008-2006	V6-3.5L	G-180		GA-2198		
CLK430						
2003	V8-4.3L	G-180				
2002	V8-4.3L	G-180		GA-2179		
2001 - 1999	V8-4.3L	G-180		GA-2179	GG-420	
CLK500						
2009-2008	V8-5.5L	G-180		GA-2198		
2007	V8-5.5L	G-180				
2006-2003	V8-5.0L	G-180		GA-2198	GG-420	
CLS350						
2011 - 2010	V8-5.5L	G-180		GA-2198		
CLS500						
2006-2005	V8-5.0L	G-918		GA-438		
E250						
2011	V6-3.5L	G-180		GA-2198		
2011	V8-5.5L	G-180		GA-2198		
E280						
2009-2008	V6-3.0L	G-180			GP-701	
1999	V6-2.8L	G-918			GG-420	
E300						
2010	V6-3.0L	G-180		GA-2198	GG-420	
2010	V6-3.5L	G-180		GA-438		
2010	V8-5.5L	G-180		GA-2198		
E320						
2005-2004	V6-3.2L	G-180		GA-2198		
2003-2002	V6-3.2L	G-180		GA-2198, GA-2164		
2001 - 2000	V6-3.2L	G-180		GA-2164		
1999 - 1998	V6-3.2L	G-180		GA-2175		
1997	V6-3.2L	G-971		GA-2175		
1996	L6-3.2L	G-918		GA-2175	GG-251	

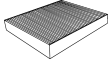
GONHER		ACEITE	SINTÉTICO	AIRE	COMB.	CABINA
AÑO	MOTOR					

MERCEDES-BENZ (Continúa)

E350

2011	V6-3.5L	G-180		GA-2198		
2010	V6-3.5L	G-180		GA-438		
2009-2006	V6-3.5L	G-180		GA-2198		

E420

1997	V8-4.2L			GA-2175		
1995 - 1994	V8-4.2L				GG-189	

E430

2001 - 1998	V8-4.3L	G-180		GA-2175	GG-420	
-------------	---------	-------	--	---------	--------	--

E500

2011 - 2010	V8-5.5L	G-180		GA-2198		
2009	V8-5.5L	G-180		GA-438		
2008-2007	V8-5.5L	G-180		GA-2198		
2006-2003	V8-5.0L	G-180		GA-2198		

E55 AMG

2001	V8-5.5L	G-180		GA-2164		
2000-1999	V8-5.5L	G-180				

G500

2015 - 2014	V8-5.5L			GA-2198		
2013 - 2012	V8-5.5L	G-180		GA-2198		
2013	V8-5.5L Turbo	G-180		GA-2198		
2011	V8-5.5L	G-180				
2010	V8-5.5L	G-180		GA-438	GG-420	
2009	V8-5.5L	G-180		GA-2198		
2008	V8-5.0L	G-180		GA-2198		
2007-2002	V8-5.0L	G-180		GA-2198	GG-420	
2000-1999	V8-5.0L	G-918			GG-420	

GL500

2012 - 2010	V8-5.5L	G-180		GA-2198		
2009	V8-5.5L	G-180		GA-438		
2008	V8-5.5L	G-180		GA-2198		

GLK300

2015	V6-3.5L			GA-2198		
2013	V6-3.5L			GA-2198		
2012 - 2011	V6-3.5L	G-180		GA-2198		

GLK350





2015	V6-3.5L			GA-2198		
2013	V6-3.5L			GA-2198		

ML320

2002 - 1999	V6-3.2L	G-180		GA-2195		
1998	V6-3.2L	G-180				

ML350

2011	V6-3.5L	G-180		GA-2198		
2011	V8-5.5L	G-180		GA-2198		
2010	V6-3.5L	G-180		GA-438		
2010	V8-5.5L	G-180		GA-438		
2009-2007	V6-3.5L	G-180		GA-2198		
2006	V6-3.5L	G-180		GA-2195		
2005-2003	V6-3.7L	G-180		GA-2195		

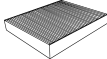
GONHER		ACEITE	SINTÉTICO	AIRE	COMB.	CABINA
AÑO	MOTOR					

MERCEDES-BENZ (Continúa)

ML430

2001 - 1998	V8-4.3L	G-180		GA-2195		
-------------	---------	-------	--	---------	--	--

ML500

2011	V8-5.5L	G-180		GA-2198		
2010 - 2009	V8-5.5L	G-180		GA-438		
2008	V8-5.5L	G-180		GA-2198		
2007	V8-5.0L	G-180		GA-2198		
2006-2002	V8-5.0L	G-180		GA-2195		

ML55 AMG

2001	V8-5.5L	G-180		GA-2198		
------	---------	-------	--	---------	--	--

R350

2013 - 2012	V6-3.5L			GA-2198		
2011	V6-3.5L	G-180		GA-2198		
2010 - 2009	V6-3.5L	G-180		GA-438		
2008	V6-3.5L	G-180		GA-2198		

R500

2007 - 2006	V8-5.0L	G-180		GA-2198		
-------------	---------	-------	--	---------	--	--

S420

1998 - 1996	V8-4.2L				GG-189	
-------------	---------	--	--	--	--------	--

S430

2005 - 2000	V8-4.3L	G-180		GA-2198	GG-420	
-------------	---------	-------	--	---------	--------	--

S500

2011 - 2010	V8-5.5L	G-180		GA-2198		
2009	V8-5.5L	G-180		GA-438		
2008 - 2007	V8-5.5L	G-180		GA-2198		
2006 - 2000	V8-5.0L	G-180		GA-2198	GG-420	
1999	V8-5.0L				GG-420	
1998 - 1996	V8-5.0L				GG-189	

S600

2003	V12 5.5L Turbo	G-180				
2001	V12 6.0L	G-180				
1998 - 1996	V12 6.0L			GA-2184	GG-189	

S600L

1995	V12 6.0L			GA-2184	GG-189	
------	----------	--	--	---------	--------	--

SL320





1997 - 1996	L6-3.2L	G-971			GG-189	
-------------	---------	-------	--	--	--------	--

SL500

2012 - 2009	V8-5.5L	G-180		GA-2198		
2008	V8-5.5L	G-180		GA-2198	GG-251	
2007	V8-5.5L	G-180		GA-2198		
2006 - 2002	V8-5.0L	G-180		GA-2198	GG-420	
2001	V8-5.0L	G-180		GA-2198		
2000 - 1999	V8-5.0L	G-180			GG-251	
1998 - 1996	V8-5.0L				GG-189	

SL55 AMG

2007 - 2003	V8-5.4L	G-918		GA-438		
2002	V8-5.0L	G-180		GA-2198	GG-420	

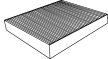
GONHER		ACEITE	SINTÉTICO	AIRE	COMB.	CABINA
AÑO	MOTOR					

MERCEDES-BENZ (Continúa)

SL600

2002 - 2000	V12 6.0L			GA-2184	GG-420	
1999	V12 6.0L			GA-2184	GG-251	
1998 - 1997	V12 6.0L			GA-2184	GG-189	
1996	V12 6.0L			GA-2184	GG-251	

SLK200

2011	V6-3.5L	G-180		GA-2198		
2010	V6-3.5L	G-180		GA-438		
2004-2003	L4-2.0L	G-971		GA-2106		

SLK230

2004-2000	L4-2.3L	G-971		GA-2106	GG-431	
1999 - 1998	L4-2.3L	G-971		GA-2106	GG-251	
1997	L4-2.3L	G-971		GA-2106		

SLK320

2004-2001	V6-3.2L	G-180		GA-2161	GG-420	
-----------	---------	-------	--	---------	--------	--

SLK350

2009-2005	V6-3.5L	G-180		GA-2198		
-----------	---------	-------	--	---------	--	--

SLK55 AMG

2011	V8-5.5L			GA-2198		
2010 - 2009	V8-5.5L			GA-438		
2008 - 2007	V8-5.5L			GA-2198		
2006-2005	V8-5.5L	G-180		GA-2198		

SLR MCLAREN

2009-2007	V8-5.4L			GA-2195		
-----------	---------	--	--	---------	--	--

SPRINTER

2016 - 2014	L4-2.1L Turbo diésel			GAVW-651		
2006-2005	L5-2.7L Turbo diésel	G-918		GA-5876	GP-701	
2004	L5-2.7L Turbo diésel	G-918		GA-5876	GPP-612	

MERCURY

COUGAR

2002 - 1999	L4-2.0L	GP-128				GAC-9
2002 - 1999	V6-2.5L					GAC-9
1997 - 1990	V6-3.8L			GA-176		

GRAND MARQUIS

2011 - 1998	V8-4.6L	GP-68	GP-68 SNG	GA-5056	GG-986	
1997 - 1992	V8-4.6L	GP-68	GP-68 SNG	GA-5056	GG-47	

MARINER





2011 - 2010	V6-3.0L	GP-405	GP-405 SNG	GA-222R	GG-1872	
2009-2005	V6-3.0L	GP-68	GP-68 SNG	GA-224	GG-47	
2007-2006	L4-2.3L	GP-58, G-70	GP-58 SNG	GA-224	GG-47	

MILAN

2009-2006	L4-2.3L			GA-1572		
2009-2006	V6-3.0L	GP-68	GP-68 SNG	GA-1544		



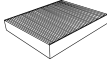

MONTEGO

2007 - 2005	V6-3.0L	GP-68	GP-68 SNG	GA-771	GG-986	
-------------	---------	-------	-----------	--------	--------	--

GONHER		ACEITE 	SINTÉTICO 	AIRE 	COMB. 	CABINA 
AÑO	MOTOR					
MERCURY (Continúa)						
MONTEREY						
2007 - 2004	V6-4.2L					GAC-2286 ⁽¹⁾
MOUNTAINEER						
1999	V6-4.0L					GAC-1
1999	V8-5.0L					GAC-1
MYSTIQUE						
2000 - 1995	L4-2.0L					GAC-9
2000 - 1995	V6-2.5L					GAC-9
SABLE						
2005 - 1993	V6-3.0L	GP-68	GP-68 SNG	GA-224	GG-307	
2004	V6-3.0L	GP-68	GP-68 SNG	GA-224	GG-47	
TOPAZ						
1993	V6-3.0L	GP-3600	GP-3600 SNG	GA-217	GG-47	
1992 - 1990	L4-2.3L			GA-176		
TRACER						
1999 - 1997	L4-2.0L			GA-130		
1999	L4-2.0L	GP-3600	GP-3600 SNG	GA-130	GG-30	
VILLAGER						
1998 - 1993	V6-3.0L	GP-37				
MG						
ZT						
2005 - 2003	V6-2.5L	GP-453				
MINI						
COOPER						
2016 - 2015	L4-1.6L	G-341		GA-926		
2016 - 2015	L4-1.6L Turbo	G-341		GA-926		
2014 - 2007	L4-1.6L	G-341		GA-926, GA-2217		
2014 - 2007	L4-1.6L Turbo	G-341		GA-926, GA-2217		
2006 - 2002	L4-1.6L	G-446		GA-926		
COOPER COUNTRYMAN						
2016 - 2011	L4-1.6L Turbo	G-341		GA-4444, GA-2217		
COOPER PACEMAN						
2016	L4-1.6L Turbo	G-341		GA-2217 ⁽¹⁾		
2015 - 2013	L4-1.6L Turbo	G-341		GA-4444, GA-2217		
MITSUBISHI						
3000GT						
1999 - 1991	V6-3.0L			GA-7142		
1999 - 1991	V6-3.0L Turbo			GA-7142		
ASX						
2015 - 2013	L4-2.0L	GP-149	GP-149 SNG			GAC-99

(1) Nuevo

Los filtros Gonher prolongan la vida útil del motor evitando el desgaste prematuro.
Para vehículos anteriores a 1990, consulte nuestro catálogo web en www.grupogonher.com

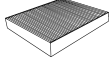
GONHER		ACEITE	SINTÉTICO	AIRE	COMB.	CABINA
AÑO	MOTOR					

MITSUBISHI (Continúa)

DIAMANTE

1996 - 1992	V6-3.0L			GA-7142		
-------------	---------	--	--	---------	--	--

ECLIPSE

2012	V6-3.8L	GP-6811	GP-6811 SNG	GA-606		
2011	V6-3.8L	GP-149	GP-149 SNG	GA-606		
2009-2008	V6-3.8L	GP-149	GP-149 SNG	GA-606		
2007-2006	V6-3.8L	GP-145		GA-606		
2005-2000	V6-3.0L	GP-149	GP-149 SNG	GA-7344		
1995	L4-2.0L			GA-476		

ENDEAVOR

2011 - 2008	V6-3.8L	GP-149	GP-149 SNG	GA-606		
2007-2006	V6-3.8L	GP-145		GA-606		
2005-2004	V6-3.8L	GP-149	GP-149 SNG	GA-606		

GALANT

2009-2006	L4-2.4L	GP-6811	GP-6811 SNG	GA-606		
2009	V6-3.8L	GP-149	GP-149 SNG	GA-606		
2007-2006	V6-3.8L	GP-145		GA-606		
2005-2004	L4-2.4L	GP-149	GP-149 SNG	GA-606		
2005-2004	V6-3.8L	GP-149	GP-149 SNG	GA-606		
2003-1999	V6-3.0L	GP-149	GP-149 SNG	GA-7344		
2003-1994	L4-2.4L	GP-6811	GP-6811 SNG	GA-606		

GRANDIS

2009-2007	L4-2.4L	GP-149	GP-149 SNG	GA-8274 ⁽¹⁾		
-----------	---------	--------	------------	------------------------	--	--

L200

2017 - 2015	L4-2.4L	GP-149	GP-149 SNG	GA-603		
2017 - 2013	L4-2.5L Turbo diésel	GP-112		GA-603		
2014 - 2008	L4-2.4L	GP-149	GP-149 SNG	GA-603	GG-235	
2012 - 2008	L4-2.5L Turbo diésel	GP-112		GA-603	GP-4922	
2009-2008	L4-2.4L Turbo	GP-149	GP-149 SNG	GA-603	GG-235	





LANCER

2017 - 2016	L4-2.0L			GA-8274 ⁽¹⁾		
2017 - 2016	L4-2.4L			GA-8274 ⁽¹⁾		
2016	L4-2.0L	GP-149	GP-149 SNG	GA-8274 ⁽¹⁾		
2015-2008	L4-2.0L	GP-6811	GP-6811 SNG	GA-609		GAC-99
2015	L4-2.4L	GP-6811	GP-6811 SNG			GAC-99
2014-2013	L4-2.4L	GP-149	GP-149 SNG	GA-609		GAC-99
2014	L4-2.0L Turbo	GP-6811	GP-6811 SNG	GA-609		GAC-99
2012	L4-2.4L	GP-6811	GP-6811 SNG	GA-609		GAC-99
2011-2009	L4-2.4L	GP-149	GP-149 SNG	GA-609		GAC-99
2008	L4-2.0L	GP-6811	GP-6811 SNG	GA-609		
2007	L4-2.0L	GP-149	GP-149 SNG	GA-607		
2006-2005	L4-2.4L	GP-6811	GP-6811 SNG	GA-607		
2006	L4-2.0L	GP-6811	GP-6811 SNG	GA-607		
2006	L4-2.0L Turbo	GP-6811	GP-6811 SNG	GA-607		
2005-2004	L4-2.0L	GP-149	GP-149 SNG	GA-607		
2005-2004	L4-2.0L Turbo	GP-149	GP-149 SNG	GA-607		

MIGHTY MAX

1996 - 1990	L4-2.4L			GA-7142		
1994 - 1990	V6-3.0L			GA-7142		

(1) Nuevo

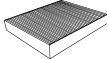
GONHER		ACEITE	SINTÉTICO	AIRE	COMB.	CABINA
AÑO	MOTOR					

MITSUBISHI (Continúa)

MIRAGE

2020 - 2019	L3-1.2L	GP-149	GP-149 SNG	GA-1500		
2018 - 2015	L3-1.2L	GP-149	GP-149 SNG	GA-1500		GAC-2276 ⁽¹⁾
2002 - 1997	L4-1.5L				GG-164	
2002 - 1997	L4-1.8L				GG-164	

MONTERO

2017	V6-3.8L	GP-6811	GP-6811 SNG			
2016	V6-3.8L	GP-6811	GP-6811 SNG	GA-7147		
2015	V6-3.8L	GP-149	GP-149 SNG			
2014 - 2008	V6-3.8L	GP-6811	GP-6811 SNG			
2006 - 2003	V6-3.8L	GP-6811	GP-6811 SNG	GA-7147		
1994 - 1992	V6-3.0L			GA-7142		

MONTERO SPORT

2011	V6-3.5L	GP-149	GP-149 SNG	GA-7147		
2010	V6-3.5L	GP-149	GP-149 SNG	GA-605		
2004 - 2003	V6-3.5L	GP-6811	GP-6811 SNG	GA-605	GG-233	

OUTLANDER

2020 - 2014	L4-2.4L			GA-8274 ⁽¹⁾		
2020 - 2014	V6-3.0L			GA-8274 ⁽¹⁾		
2019 - 2014	L4-2.4L	GP-149	GP-149 SNG	GA-8274 ⁽¹⁾		
2013 - 2011	V6-3.0L	GP-149	GP-149 SNG	GA-609		GAC-99
2013	L4-2.4L	GP-149	GP-149 SNG	GA-609		
2012	L4-2.4L	GP-6811	GP-6811 SNG	GA-609		
2011 - 2010	L4-2.4L	GP-149	GP-149 SNG	GA-609		
2010	V6-3.0L	GP-91	GP-91 SNG	GA-609		GAC-99
2009 - 2008	L4-2.4L	GP-6811	GP-6811 SNG	GA-609		
2009 - 2007	V6-3.0L	GP-6811	GP-6811 SNG	GA-609		GAC-99
2007	V6-3.0L	GP-6811	GP-6811 SNG	GA-609		
2006 - 2004	L4-2.4L	GP-6811	GP-6811 SNG	GA-607		

OUTLANDER SPORT

2020 - 2016	L4-2.0L			GA-8274 ⁽¹⁾		
2019 - 2015	L4-2.4L			GA-8274 ⁽¹⁾		
2015 - 2013	L4-2.0L	GP-149	GP-149 SNG	GA-8274 ⁽¹⁾		
2012 - 2011	L4-2.0L	GP-149	GP-149 SNG			

SPACE STAR

2004 - 2003	L4-1.8L	GP-149	GP-149 SNG	GA-283		
-------------	---------	--------	------------	--------	--	--

NISSAN

200SX

1998 - 1995	L4-1.6L	GP-3682		GAD-15	GG-63	
1998 - 1995	L4-2.0L	GP-91	GP-91 SNG	GAD-15	GG-63	





240SX

1998	L4-2.4L	GP-37		GAD-15	GG-63	
1993	L4-2.4L	GP-37		GAD-15	GG-63	

300ZX

1996 - 1995	V6-3.0L Turbo	GP-37		GAD-17	GG-94	
1996 - 1991	V6-3.0L	GP-37		GAD-17	GG-94	

(1) Nuevo

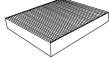
GONHER		ACEITE	SINTÉTICO	AIRE	COMB.	CABINA
AÑO	MOTOR					
NISSAN (Continúa)						

350Z

2008	V6-3.5L	GP-91	GP-91 SNG			
2007 - 2006	V6-3.5L	GP-91	GP-91 SNG	GAD-15		
2005	V6-3.5L	GP-149	GP-149 SNG	GAD-15		
2004 - 2003	V6-3.5L	GP-91	GP-91 SNG	GAD-15		

370Z

2019 - 2009	V6-3.7L	GP-91	GP-91 SNG			
-------------	---------	-------	-----------	--	--	--

ALMERA

2005 - 2001	L4-1.8L	GP-91	GP-91 SNG	GAD-15	GG-137	
-------------	---------	-------	-----------	--------	--------	--

ALTIMA

2020 - 2019	L4-2.0L Turbo	GP-91	GP-91 SNG			
2020 - 2019	L4-2.5L	GP-91	GP-91 SNG			
2018 - 2013	L4-2.5L	GP-91	GP-91 SNG	GA-1531		
2017 - 2010	V6-3.5L	GP-91	GP-91 SNG	GAD-15		
2012 - 2009	L4-2.5L	GP-91	GP-91 SNG	GA-1530		
2011 - 2009	L4-2.5L Híbrido	GP-91	GP-91 SNG	GA-1530		
2009	V6-3.5L	GP-91	GP-91 SNG	GAD-15	GG-137	
2008 - 2007	L4-2.5L	GP-149	GP-149 SNG	GA-1530		
2008 - 2007	L4-2.5L Híbrido	GP-91	GP-91 SNG	GA-1530		GAC-27
2008 - 2007	V6-3.5L	GP-149	GP-149 SNG	GAD-15	GG-137	
2006 - 2005	V6-3.5L	GP-149	GP-149 SNG	GAD-15	GG-137	GAC-99
2006 - 2002	L4-2.5L	GP-149	GP-149 SNG	GAD-15	GG-137	GAC-99
2004 - 2002	V6-3.5L	GP-91	GP-91 SNG	GAD-15	GG-137	GAC-99
2001 - 1998	L4-2.4L	GP-149	GP-149 SNG	GAD-15	GG-137	
1997 - 1995	L4-2.4L	GP-37		GAD-15	GG-137	
1994 - 1993	L4-2.4L			GAD-15	GG-137	

APRIO

2010 - 2008	L4-1.6L	GP-291		GA-291, GA-525	GG-291	
-------------	---------	--------	--	-------------------	--------	--

ARMADA

2018 - 2017	V8-5.6L	GP-149	GP-149 SNG			
2015 - 2011	V8-5.6L	GP-149	GP-149 SNG	GA-300		
2010	V8-5.6L	GP-91	GP-91 SNG	GA-300		
2009 - 2005	V8-5.6L	GP-149	GP-149 SNG	GA-300		

CABSTAR

2016 - 2011	L4-2.5L Turbo diésel	GP-171		GAD-46R		
2009 - 2008	L4-2.5L Turbo diésel	GP-171		GAD-46R	GPP-5773	

CABSTAR E

2009 - 2008	L4-2.5L Turbo diésel	GP-171		GAD-46R	GPP-5773	
-------------	----------------------	--------	--	---------	----------	--

CUBE





2014 - 2009	L4-1.8L					GAC-2287 ⁽¹⁾
-------------	---------	--	--	--	--	-------------------------

FRONTIER

2019 - 2005	V6-4.0L	GP-91	GP-91 SNG	GA-300		
2015 - 2011	L4-2.4L	GP-149	GP-149 SNG	GAD-294		
2009	L4-2.5L			GA-1546		
2008	L4-2.4L	GP-149	GP-149 SNG	GAD-294		
2007 - 2006	L4-2.4L	GP-149	GP-149 SNG	GAD-294	GG-63	
2007 - 2005	L4-2.5L			GA-1546		
2004 - 2001	L4-2.4L	GP-149	GP-149 SNG	GAD-294	GG-63	
2004 - 1999	V6-3.3L	GP-91	GP-91 SNG	GAD-15		

(1) Nuevo

Los filtros Gonher prolongan la vida útil del motor evitando el desgaste prematuro.
Para vehículos anteriores a 1990, consulte nuestro catálogo web en www.grupogonher.com

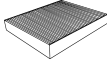
GONHER		ACEITE	SINTÉTICO	AIRE	COMB.	CABINA
AÑO	MOTOR					

NISSAN (Continúa)

FRONTIER (Continúa)

2000 - 1998	L4-2.4L	GP-149	GP-149 SNG	GAD-294		
-------------	---------	--------	------------	---------	--	--

GT-R

2018 - 2017	V6-3.8L Turbo	GP-149	GP-149 SNG			
-------------	---------------	--------	------------	--	--	--

HIKARI

1992 - 1990	L4-1.6L	GP-37		GAD-15	GG-39	
1992 - 1990	L4-1.6L Turbo	GP-37		GAD-15	GG-39	

ICHI VAN

1994 - 1991	L4-2.4L	GP-3682		GAD-15		
1992	L4-1.8L	GP-38		GAD-30	GG-45	
1991 - 1990	L4-1.8L	GP-38		GAD-15	GG-39	

JUKE

2017 - 2012	L4-1.6L Turbo	GP-91	GP-91 SNG	GAD-117		GAC-2287 ⁽¹⁾
-------------	---------------	-------	-----------	---------	--	-------------------------

KICKS

2021	L4-1.6L			GAD-6554		GAC-2330
2020 - 2017	L4-1.6L	GP-91	GP-91 SNG	GAD-6554 ⁽¹⁾		GAC-2330

LEAF

2019 - 2011	Eléctrico					GAC-2287 ⁽¹⁾
-------------	-----------	--	--	--	--	-------------------------

LUCINO

2000	L4-1.6L	GP-37		GAD-117	GG-137	
2000	L4-2.0L	GP-91	GP-91 SNG	GAD-117	GG-137	
1999 - 1996	L4-1.6L	GP-37		GAD-15	GG-63	
1999 - 1996	L4-2.0L	GP-91	GP-91 SNG	GAD-15	GG-63	

MARCH

2020 - 2012	L4-1.6L	GP-91	GP-91 SNG	GA-306		
-------------	---------	-------	-----------	--------	--	--

MAXIMA

2020 - 2011	V6-3.5L	GP-91	GP-91 SNG	GAD-15		
2010 - 2007	V6-3.5L	GP-91	GP-91 SNG	GAD-15		GAC-27
2006	V6-3.5L	GP-91	GP-91 SNG	GAD-15		GAC-99
2005	V6-3.5L	GP-149	GP-149 SNG	GAD-15		GAC-99
2004	V6-3.5L	GP-149	GP-149 SNG	GAD-15	GG-63	GAC-99
2003-2002	V6-3.5L	GP-91	GP-91 SNG	GAD-15		
2001 - 1995	V6-3.0L	GP-149	GP-149 SNG	GAD-15	GG-63	
1993 - 1991	V6-3.0L	GP-37		GAD-15	GG-63	

MICRA

2007-2005	L4-1.4L	GP-156	GP-156 SNG	GAD-315		
-----------	---------	--------	------------	---------	--	--



MURANO

2020 - 2018	V6-3.5L	GP-91	GP-91 SNG	GAD-15		
2014 - 2008	V6-3.5L	GP-91	GP-91 SNG	GAD-15		
2007	V6-3.5L	GP-149	GP-149 SNG	GAD-15		GAC-99
2006	V6-3.5L	GP-91	GP-91 SNG	GAD-15		GAC-99
2005-2004	V6-3.5L	GP-149	GP-149 SNG	GAD-15		GAC-99

NOTE

2019 - 2014	L4-1.6L	GP-91	GP-91 SNG	GA-306		
-------------	---------	-------	-----------	--------	--	--

(1) Nuevo

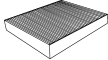
GONHER		ACEITE	SINTÉTICO	AIRE	COMB.	CABINA
AÑO	MOTOR					

NISSAN (Continúa)

NP300

2020 - 2016	L4-2.5L	GP-149	GP-149 SNG	GAD-295		
2018 - 2017	L4-2.5L Turbo diésel	GP-149	GP-149 SNG	GAD-295		
2015 - 2014	L4-2.5L Turbo diésel	GP-91	GP-91 SNG	GAD-295		
2015 - 2010	L4-2.4L	GP-149	GP-149 SNG	GAD-294		
2013 - 2011	L4-2.5L Turbo diésel	G-25		GAD-36	GP-16405-02N10	
2010 - 2009	L4-2.5L Turbo diésel	GP-81	GP-81 SNG	GAD-294		
2010	L4-2.5L Turbo	GP-149	GP-149 SNG	GAD-294		

NP300 FRONTIER

2020 - 2016	L4-2.5L	GP-149	GP-149 SNG			
2019	L4-2.5L Turbo diésel			GA-2222 ⁽¹⁾		
2018 - 2017	L4-2.5L Turbo diésel	GP-149	GP-149 SNG	GA-2222 ⁽¹⁾		

NV2500

2015 - 2013	V6-4.0L	GP-149	GP-149 SNG	GA-300		
2013	V8-5.6L	GP-149	GP-149 SNG	GA-300		

NV350 URVAN

2020 - 2014	L4-2.5L	GP-149	GP-149 SNG	GAK-16		
2019 - 2014	L4-2.5L Turbo diésel	GP-171		GAK-16		

PATHFINDER

2019 - 2013	V6-3.5L	GP-91	GP-91 SNG	GAD-15		
2012 - 2011	V6-4.0L	GP-149	GP-149 SNG	GA-300		
2010	V6-4.0L	GP-91	GP-91 SNG	GA-300		
2009-2005	V6-4.0L	GP-149	GP-149 SNG	GA-300		
2004-2002	V6-3.5L	GP-91	GP-91 SNG	GAD-15	GG-63	
2001	V6-3.5L	GP-149	GP-149 SNG	GAD-15	GG-63	
2000-1997	V6-3.3L	GP-149	GP-149 SNG	GAD-15	GG-63	
1996	V6-3.3L				GG-98	

PATHFINDER ARMADA

2004	V8-5.6L	GP-149	GP-149 SNG	GA-300		
------	---------	--------	------------	--------	--	--

PICKUP

2010	L4-2.4L	GP-149	GP-149 SNG	GAD-294		
2010	L4-2.5L Turbo diésel	G-25		GAD-36	GP-16405-02N10	
2009-2008	L4-2.4L	GP-149	GP-149 SNG	GAD-294	GG-137	
2007-1993	L4-2.4L	GP-3682		GAD-294	GG-137	
1995	V6-3.0L	GP-37				
1992 - 1991	L4-2.4L	GP-3682		GA-4325	GG-45	
1992 - 1990	L4-1.8L	GP-38		GAD-3	GG-45	

PLATINA

2010-2002	L4-1.6L	GP-291		GA-291	GG-291	
-----------	---------	--------	--	--------	--------	--





QUEST

2009-2004	V6-3.5L	GP-91	GP-91 SNG	GAD-15		
2002	V6-3.3L	GP-149	GP-149 SNG	GAD-118	GG-63	
2001 - 1999	V6-3.3L	GP-149	GP-149 SNG	GAD-118	GG-94	
1998 - 1997	V6-3.0L	GP-3682		GAD-118	GG-94	
1996 - 1993	V6-3.0L	GP-37		GAD-118	GG-94	

ROGUE

2014 - 2008	L4-2.5L	GP-91	GP-91 SNG	GAD-117		GAC-27
-------------	---------	-------	-----------	---------	--	--------

(1) Nuevo

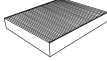
GONHER		ACEITE	SINTÉTICO	AIRE	COMB.	CABINA
AÑO	MOTOR					

NISSAN (Continúa)

SENTRA

2020 - 2017	L4-1.6L Turbo	GP-91	GP-91 SNG	GAD-117		GAC-2287
2020	L4-1.8L	GP-91	GP-91 SNG	GAD-117		GAC-2287
2019 - 2013	L4-1.8L	GP-91	GP-91 SNG	GAD-117		GAC-2287 ⁽¹⁾
2012 - 2007	L4-2.0L	GP-91	GP-91 SNG	GA-1529		GAC-27
2012 - 2007	L4-2.5L	GP-91	GP-91 SNG	GAD-117		GAC-27
2006-2004	L4-1.8L	GP-149	GP-149 SNG	GAD-15		GAC-99
2006-2002	L4-2.5L	GP-149	GP-149 SNG	GAD-15		GAC-99
2003-2000	L4-1.8L	GP-91	GP-91 SNG	GAD-15	GG-137	GAC-99
2001-2000	L4-2.0L	GP-91	GP-91 SNG	GAD-15		GAC-99
2000	L4-1.6L	GP-3682		GAD-117	GG-137	
1999 - 1996	L4-2.0L	GP-91	GP-91 SNG	GAD-15	GG-63	
1999 - 1993	L4-1.6L	GP-3682		GAD-15	GG-63	
1994 - 1991	L4-2.0L	GP-156		GAD-15	GG-63	

TIIDA

2018 - 2013	L4-1.6L	GP-91	GP-91 SNG	GA-306		GAC-89
2018 - 2007	L4-1.8L	GP-91	GP-91 SNG	GAD-116		GAC-89

TITAN

2015 - 2011	V8-5.6L	GP-149	GP-149 SNG	GA-300		
2010	V8-5.6L	GP-91	GP-91 SNG	GA-300		
2009-2004	V8-5.6L	GP-149	GP-149 SNG	GA-300		

TSUBAME

2004 - 1993	L4-1.6L	GP-37		GAD-15	GG-63	
-------------	---------	-------	--	--------	-------	--

TSURU

2017 - 2009	L4-1.6L	GP-156	GP-156 SNG	GAD-117	GG-137	
2008-2005	L4-1.6L	GP-3682		GAD-117	GG-137	
2004 - 1997	L4-1.6L	GP-37		GAD-117	GG-137	
1996 - 1993	L4-1.6L	GP-37		GAD-15	GG-63	
1996 - 1993	L4-2.0L	GP-156	GP-156 SNG	GAD-15	GG-63	
1992	L4-1.6L	GP-37		GA-6619, GA-6620	GG-63	
1991 - 1990	L4-1.6L	GP-37		GAD-3	GG-39	

URVAN

2013 - 2012	L4-3.0L Turbo diésel	G-5208		GAK-16		
2013 - 2008	L4-2.5L	GP-149	GP-149 SNG	GAK-16		
2011 - 2008	L4-3.0L Turbo diésel	G-5208		GAK-16	GP-16405- 01T70	
2008	L4-2.4L	GP-149	GP-149 SNG	GAD-29		
2008	L4-3.0L Diésel	G-5208		GAK-16	GP-16405- 01T70	
2007-2005	L4-2.4L	GP-149	GP-149 SNG	GAD-34	GG-6400	
2004-2002	L4-2.4L	GP-149	GP-149 SNG	GAD-29	GG-6400	
2001-2000	L4-2.4L	GP-149	GP-149 SNG	GAD-294	GG-63	

V-DRIVE





2020	L4-1.6L	GP-91	GP-91 SNG	GA-306		
------	---------	-------	-----------	--------	--	--

VERSA

2021	L4-1.6L			GAD-6554		GAC-2330
2020	L4-1.6L	GP-91	GP-91 SNG	GAD-6554 ⁽¹⁾		GAC-2330
2019 - 2012	L4-1.6L	GP-91	GP-91 SNG	GA-306		
2009 - 2007	L4-1.8L	GP-91	GP-91 SNG	GAD-116		
2009	L4-1.6L	GP-91	GP-91 SNG	GAD-116		

(1) Nuevo

Los filtros Gonher prolongan la vida útil del motor evitando el desgaste prematuro.
Para vehículos anteriores a 1990, consulte nuestro catálogo web en www.grupogonher.com

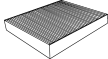
GONHER		ACEITE	SINTÉTICO	AIRE	COMB.	CABINA
AÑO	MOTOR					

NISSAN (Continúa)

XTERRA

2009	V6-4.0L	GP-149	GP-149 SNG	GA-300		
2007 - 2005	V6-4.0L	GP-149	GP-149 SNG	GA-300		
2004 - 2000	V6-3.3L	GP-91	GP-91 SNG	GAD-15	GG-63	

X-TRAIL

2020 - 2018	L4-2.0L Híbrido	GP-91	GP-91 SNG	GAD-546		
2020 - 2015	L4-2.5L	GP-91	GP-91 SNG	GAD-546		
2014 - 2011	L4-2.5L	GP-91	GP-91 SNG	GAD-117		
2010 - 2008	L4-2.5L	GP-149	GP-149 SNG	GAD-15		GAC-27
2007	L4-2.5L	GP-91	GP-91 SNG	GAD-15		GAC-27
2006 - 2005	L4-2.5L	GP-91	GP-91 SNG	GAD-15		GAC-99
2004 - 2002	L4-2.5L	GP-91	GP-91 SNG	GAD-15		

OLDSMOBILE

88

1999 - 1996	V6-3.8L	GP-46		GA-6479	GG-290	
1995	V6-3.8L	GP-46		GA-6479	GG-66	
1994	V6-3.8L	GP-46		GA-6479	GG-290	
1993	V6-3.8L	GP-46		GA-6479	GG-581	
1992	V6-3.8L	GP-46		GA-6479	GG-290	

98

1996 - 1994	V6-3.8L			GA-6479		
-------------	---------	--	--	---------	--	--

ALERO

2004 - 2002	L4-2.2L	G-49		GA-279	GG-66	
2004 - 2000	V6-3.4L	GP-46		GA-279	GG-66	
2001 - 2000	L4-2.4L	GP-44		GA-279	GG-66	

AURORA

1999 - 1995	V8-4.0L			GA-6479		
-------------	---------	--	--	---------	--	--

BRAVADA

2004 - 2002	L6-4.2L			GA-414R	GG-209	
2001 - 1996	V6-4.3L			GA-165		
1994 - 1993	V6-4.3L			GA-165		

CUTLASS





1999 - 1997	V6-3.1L	GP-3980		GA-6626		
1996 - 1995	V6-3.1L	GP-46		GA-164	GG-66	
1994	V6-3.1L	GP-46, GP-48		GA-164	GG-66	
1993	V6-3.1L	GP-46, GP-48		GA-253	GG-66	
1992	V6-3.1L	GP-3980, GP-48		GA-6626	GG-66	
1991	V6-3.1L	GP-3980, GP-48		GA-6626	GG-46	
1990	V6-3.1L	GP-3980		GA-6626		

CUTLASS CIERA

1996 - 1995	L4-2.2L				GG-256	
1996 - 1995	V6-3.1L				GG-256	

INTRIGUE

2001 - 1999	V6-3.5L			GA-6479		
-------------	---------	--	--	---------	--	--

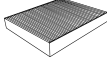
GONHER		ACEITE	SINTÉTICO	AIRE	COMB.	CABINA
AÑO	MOTOR					

OLDSMOBILE (Continúa)

SILHOUETTE

1995 - 1993	V6-3.8L	GP-3980		GA-3916	GG-177	
1993 - 1991	V6-3.1L	GP-3980		GA-3588	GG-177	

PEUGEOT

2008

2016 - 2014	L4-1.6L	G-341			GG-291	
-------------	---------	-------	--	--	--------	--

206

2009-2003	L4-1.4L	G-341		GA-2159	GG-291	GAC-5
2009	L4-1.6L	G-341		GA-2159	GG-291	GAC-5
2008-2001	L4-1.6L	G-141		GA-2159	GG-291	GAC-5
2002-2000	L4-1.4L	GP-461		GA-2159	GG-291	GAC-5

207

2014	L4-1.6L Turbo	G-341				
2013 - 2011	L4-1.6L	G-341		GA-2144	GG-291	
2013 - 2011	L4-1.6L Turbo	G-341		GA-2144	GG-291	
2011 - 2009	L4-1.4L	G-341			GG-291	
2010 - 2008	L4-1.6L Turbo	G-341		GA-2144, GA-2217	GG-291	
2010	L4-1.6L	G-341		GA-2144, GA-2217	GG-291	

208

2018	L4-1.6L	G-341				
2017	L4-1.6L	G-341			GG-291	
2017	L4-1.6L Turbo diésel	G-241			GG-291	
2016 - 2014	L4-1.6L	G-341		GA-1444	GG-291	
2016	L4-1.6L Turbo diésel	G-241		GA-1444	GG-291	

208 GT

2017 - 2014	L4-1.6L Turbo	G-341		GA-4444 ⁽¹⁾	GG-291	
-------------	---------------	-------	--	------------------------	--------	--

3008

2018	L4-1.6L Turbo	G-341				
2017 - 2015	L4-1.6L Turbo	G-341		GA-2227 ⁽¹⁾	GG-291	
2011	L4-1.6L Turbo	G-341				

301

2018 - 2017	L4-1.6L	G-341		GA-2184		
2018 - 2015	L4-1.6L Turbo diésel	G-241		GA-1444		
2016	L4-1.6L	G-341		GA-2184	GG-291	
2015	L4-1.6L	G-341		GA-2184		

306

2002 - 1998	L4-1.8L	GP-461		GA-2123	GG-291	
1997	L4-1.6L	GP-461		GA-2160	GG-291	

307





2010 - 2007	L4-2.0L	G-341		GA-215	GG-291	
2006 - 2003	L4-2.0L	GP-461		GA-215	GG-291	

308



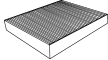

2017 - 2016	L4-1.6L	G-341			GG-291	
2017 - 2016	L4-1.6L Turbo	G-341			GG-291	
2012	L4-1.6L Turbo	G-341		GA-2227 ⁽¹⁾		
2011 - 2009	L4-1.6L Turbo	G-341		GA-4444, GA-2227		

(1) Nuevo

Los filtros Gonher prolongan la vida útil del motor evitando el desgaste prematuro.
Para vehículos anteriores a 1990, consulte nuestro catálogo web en www.grupogonher.com

GONHER.		ACEITE 	SINTÉTICO 	AIRE 	COMB. 	CABINA 
AÑO	MOTOR					
PEUGEOT (Continúa)						
405						
1999 - 1997	L4-2.0L			GA-2173	GG-251	
406						
2005-2003	V6-2.9L	GP-461		GA-2156		
2005-2000	L4-2.0L	GP-461		GA-2156	GG-291	
2002-2001	V6-3.0L	GP-461		GA-2156	GG-291	
508						
2017 - 2012	L4-1.6L Turbo	G-341		GA-4444 ⁽¹⁾	GG-291	
607						
2008-2002	V6-2.9L			GA-2156		
EXPERT						
2008	L4-2.0L	G-341				
GRAND RAID						
2010 - 2007	L4-1.6L	G-141		GA-2184	GG-291	
MANAGER						
2019 - 2017	L4-2.2L Turbo diésel			GA-2220R		
2016 - 2011	L4-2.2L Turbo diésel	GP-109		GA-2220R	G-723	
2016	L4-3.0L Turbo diésel			GA-2220R		
2015 - 2009	L4-3.0L Turbo diésel	GP-109		GA-2220R	G-723	
2009	L4-3.0L Diésel	GP-109		GA-2220R	G-723	
PARTNER						
2018	L4-1.6L Turbo diésel	G-241		GA-1444		
2017	L4-1.6L Turbo diésel	G-241		GA-2227 ⁽¹⁾		
2016 - 2009	L4-1.6L Turbo diésel	G-241		GA-2227 ⁽¹⁾	G-723	
2012 - 2011	L4-1.6L			GA-114	G-723	
2010 - 2009	L4-1.6L	G-141		GA-114	GG-291	
2008	L4-1.6L	G-141		GA-2173	GG-291	
2007-2003	L4-1.6L	G-141		GA-114	GG-291	
RCZ						
2016 - 2012	L4-1.6L Turbo	G-341		GA-4444 ⁽¹⁾		
2011	L4-1.6L Turbo	G-341		GA-2144	GG-291	
PLYMOUTH						
ACCLAIM						
1993	L4-2.5L	GP-81	GP-81 SNG	GA-277	GG-7018	
BREEZE						
2000-1998	L4-2.0L			GA-132		
2000-1998	L4-2.4L			GA-132		
1997 - 1996	L4-2.0L			GA-132	GG-104	
1997	L4-2.4L			GA-132	GG-104	
GRAND VOYAGER						
1995	V6-3.8L	GP-81	GP-81 SNG	GA-271	GG-65	
LASER						
1994 - 1993	L4-2.0L Turbo	GP-149	GP-149 SNG	GA-362	GG-185	
1993	L4-1.8L	GP-40				

(1) Nuevo

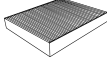
GONHER		ACEITE	SINTÉTICO	AIRE	COMB.	CABINA
AÑO	MOTOR					

PLYMOUTH (Continúa)

NEON

2001 - 1999	L4-2.0L	GP-58	GP-58 SNG	GA-278R		
1997 - 1995	L4-2.0L				GG-95	

VOYAGER

2000-1996	V6-3.0L				GG-267	
2000-1996	V6-3.3L				GG-267	
2000	V6-3.3L				GG-267	GAC-2
1999	V6-3.8L				GG-267	

PONTIAC

6000

1991 - 1990	V6-3.1L				GG-256	
-------------	---------	--	--	--	--------	--

AZTEK

2005 - 2001	V6-3.4L	GP-46		GA-164	GG-290	
-------------	---------	-------	--	--------	--------	--

BONNEVILLE

2005-2004	V8-4.6L	GP-3675		GA-164	GG-66	
2005 - 1993	V6-3.8L	GP-46		GA-6479	GG-66	

FIREBIRD

2002 - 1998	V6-3.8L	GP-46		GA-392	GG-66	
2002	V8-5.7L	GP-44		GA-165	GG-66	
2001 - 1998	V8-5.7L	GP-44		GA-392	GG-66	
1997 - 1995	V6-3.8L	GP-46		GA-165	GG-66	
1997 - 1993	V8-5.7L	GP-3		GA-165	GG-66	
1995 - 1993	V6-3.4L	GP-46		GA-165	GG-66	

G3

2010 - 2009	L4-1.6L					GAC-2278 ⁽¹⁾
2009	L4-1.6L	G-3751		GA-324		GAC-2278 ⁽¹⁾
2008 - 2007	L4-1.6L	GP-46		GA-324		

G4

2006 - 2005	L4-2.2L	GP-46		GA-164		
2006	L4-2.4L	GP-46		GA-164		

G5

2009 - 2007	L4-2.2L	G-49		GA-9969 ⁽¹⁾		
2008 - 2007	L4-2.4L	G-49		GA-9969 ⁽¹⁾		

G6

2010	V6-3.5L			GA-9948 ⁽¹⁾		
2009 - 2008	V6-3.9L	GP-3675		GA-1546		
2009 - 2007	V6-3.5L	GP-3675		GA-9948 ⁽¹⁾		
2009 - 2007	V6-3.6L	GP-406	GP-406 SNG	GA-367		
2009	L4-2.4L	G-49		GA-367		
2009	V6-3.5L	GP-3675				
2008 - 2006	L4-2.4L	G-49		GA-9948 ⁽¹⁾		
2007 - 2006	V6-3.9L	GP-3675		GA-9948 ⁽¹⁾		
2006 - 2005	V6-3.5L			GA-9948 ⁽¹⁾		
2006 - 2005	V6-3.5L	GP-46		GA-9948 ⁽¹⁾		

G8





2009	V6-3.6L	G-765				
2009	V8-6.0L	GP-406	GP-406 SNG			
2009	V8-6.2L	GP-406	GP-406 SNG			

(1) Nuevo

Los filtros Gonher prolongan la vida útil del motor evitando el desgaste prematuro.
Para vehículos anteriores a 1990, consulte nuestro catálogo web en www.grupogonher.com

FILTROS

PLYMOUTH

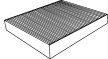
GONHER.		ACEITE	SINTÉTICO	AIRE	COMB.	CABINA
AÑO	MOTOR					

PONTIAC (Continúa)

GRAND AM

2005 - 2002	L4-2.2L	G-49		GA-279	GG-66	
2005 - 1999	V6-3.4L	GP-46		GA-279	GG-66	
2001 - 1999	L4-2.4L	GP-44		GA-279	GG-66	
1998 - 1996	L4-2.4L	GP-44			GG-66	
1998 - 1994	V6-3.1L	GP-46			GG-66	
1995 - 1993	L4-2.3L	GP-46		GA-3916	GG-66	

GRAND PRIX

2008 - 2007	V8-5.3L	GP-406	GP-406 SNG			
2008 - 1999	V6-3.8L	GP-46		GA-8754	GG-66	
2006 - 2005	V8-5.3L	GP-44				
2003 - 1993	V6-3.1L	GP-46		GA-164	GG-66	
1998 - 1997	V6-3.8L	GP-46		GA-164	GG-66	
1996 - 1994	V6-3.4L	GP-3980		GA-164	GG-66	
1993	V6-3.1L	GP-3980		GA-6626	GG-66	
1993	V6-3.4L	GP-3980		GA-6626	GG-66	

MATIZ

2010 - 2006	L4-1.0L	GP-157		GA-323	GG-419	GAC-42
2005 - 2004	L4-1.0L	GP-157		GA-314	GG-419	GAC-42

MONTANA

2009 - 2006	V6-3.9L	GP-3675		GA-164		
2006 - 2005	V6-3.5L	GP-46		GA-164	GG-290	
2005	V6-3.4L	GP-46		GA-164		
2004 - 2000	V6-3.4L	GP-46		GA-164	GG-290	
1999	V6-3.4L	GP-46		GA-164		

SOLSTICE

2009 - 2006	L4-2.4L	G-49				
2009	L4-2.0L Turbo	G-49				
2007	L4-2.0L Turbo	G-49				

SUNBIRD

1994 - 1993	L4-2.0L	GP-46		GA-3916	GG-66	
1994 - 1993	V6-3.1L	GP-46		GA-153	GG-66	

SUNFIRE





2005 - 2004	L4-2.2L	G-49		GA-3916	GG-66	
2003 - 1995	L4-2.2L	GP-46		GA-3916	GG-66	
2002 - 1996	L4-2.4L	GP-44		GA-3916	GG-66	
1995	L4-2.3L	GP-46		GA-3916	GG-66	

TORRENT

2009 - 2008	V6-3.4L	GP-46		GA-367		
2007	V6-3.4L	GP-46		GA-367	GG-581	
2006	V6-3.4L	GP-46		GA-367		

TRANS SPORT

1998 - 1997	V6-3.4L	GP-46		GA-164	GG-177	
1996	V6-3.4L	GP-46		GA-3916	GG-177	
1995 - 1993	V6-3.8L	GP-46		GA-3916	GG-177	
1995	V6-3.1L	GP-46		GA-3588	GG-177	
1994 - 1993	V6-3.1L	GP-3980		GA-3588	GG-177	

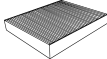
GONHER		ACEITE	SINTÉTICO	AIRE	COMB.	CABINA
AÑO	MOTOR					

PONTIAC (Continúa)

VIBE

2010	L4-1.8L					GAC-19
2010	L4-2.4L					GAC-19
2009	L4-1.8L	G-911		GA-265, GA-320		GAC-19
2009	L4-2.4L	GP-156	GP-156 SNG	GA-320		GAC-19
2007-2003	L4-1.8L	GP-157		GA-263		

PORSCHE

BOXSTER

2013	H6-2.7L			GAVW-616		
2013	H6-3.4L			GAVW-616		
2011 - 2010	H6-2.9L			GAVW-616		
2011 - 2010	H6-3.4L			GAVW-616		
2008-2006	H6-2.7L			GAVW-616		

CAYENNE

2018 - 2017	V6-3.6L			GAVW-616		
2018 - 2016	V6-3.6L Turbo			GAVW-616		
2018 - 2012	V8-4.8L Turbo			GAVW-616		
2017 - 2016	V6-3.0L Híbrido			GAVW-616		
2017 - 2016	V6-3.0L Turbo diésel			GAVW-616		
2016 - 2012	V8-4.8L			GAVW-616		
2014 - 2013	V6-3.0L Híbrido			GAVW-616		
2014 - 2013	V6-3.0L Turbo diésel			GAVW-616		
2013-2008	V6-3.6L	G-112		GAVW-616		
2011	V8-4.8L	G-112		GAVW-616		
2011	V8-4.8L Turbo	G-112		GAVW-616		
2010-2008	V8-4.8L			GAVW-616		
2010-2008	V8-4.8L Turbo			GAVW-616		
2006-2004	V6-3.2L	G-112		GAVW-616		
2006-2003	V8-4.5L			GAVW-616		
2006-2003	V8-4.5L Turbo			GAVW-616		

CAYMAN

2011 - 2009	H6-2.9L			GAVW-616		
2011 - 2006	H6-3.4L			GAVW-616		
2008-2007	H6-2.7L			GAVW-616		

RAM





1500

2019 - 2014	V6-3.6L	G-349		GA-490		
2019	V8-5.7L	GP-406	GP-406 SNG	GA-490		
2013 - 2011	V6-3.7L	GP-405	GP-405 SNG	GA-490		
2013	V8-5.7L	GP-406	GP-406 SNG	GA-490		

2500

2019	V8-5.7L	GP-406	GP-406 SNG	GA-490		
2019	V8-6.4L	GP-406	GP-406 SNG	GA-490		
2018 - 2016	V8-5.7L	GP-406	GP-406 SNG	GA-490		GAC-2293 ⁽¹⁾
2018	V8-6.4L	GP-406	GP-406 SNG	GA-490		GAC-2293 ⁽¹⁾
2015 - 2013	V8-5.7L	GP-406	GP-406 SNG	GA-490		
2013 - 2010	V8-4.7L	GP-68	GP-68 SNG	GA-490		
2012 - 2010	L6-6.7L Turbo diésel	GP-178		GA-252		
2012 - 2010	V8-5.7L	GP-68	GP-68 SNG	GA-490		

(1) Nuevo

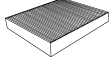
GONHER		ACEITE	SINTÉTICO	AIRE	COMB.	CABINA
AÑO	MOTOR					

RAM (Continúa)

4000

2020 - 2019	V8-5.7L	GP-406	GP-406 SNG	GA-490		
2017 - 2014	V8-5.7L	GP-406	GP-406 SNG	GA-490		
2013 - 2011	L6-6.7L Turbo diésel	GP-178		GA-252		
2013 - 2011	V8-5.7L	GP-68	GP-68 SNG	GA-490		

700

2020 - 2015	L4-1.6L	G-446		GA-6826		
-------------	---------	-------	--	---------	--	--

C/V

2015 - 2012	V6-3.6L			GA-247		
-------------	---------	--	--	--------	--	--

H100 VAN

2014	L4-2.5L Diésel	GP-112		GA-115	GPP-111	
------	----------------	--------	--	--------	---------	--

PROMASTER 1500

2020 - 2014	V6-3.6L	G-349		GA-2226R		
2017 - 2014	V6-3.6L			GA-2226R		

PROMASTER 2500

2020 - 2014	V6-3.6L	G-349		GA-2226R		
2017 - 2014	V6-3.6L			GA-2226R		

PROMASTER 3500

2020 - 2014	V6-3.6L	G-349		GA-2226R		
2017 - 2014	V6-3.6L			GA-2226R		

PROMASTER CITY

2020 - 2016	L4-2.4L	GP-406				
-------------	---------	--------	--	--	--	--

PROMASTER RAPID

2020 - 2017	L4-1.4L	GP-149	GP-149 SNG	GA-2215		
-------------	---------	--------	------------	---------	--	--

RENAULT

CAPTUR

2020 - 2019	L4-2.0L			GA-2313		
2018	L4-2.0L	GP-291		GA-2313		

CLIO

2017	L4-1.6L Turbo	GP-91	GP-91 SNG	GA-291		GAC-2349
2015	L4-1.6L Turbo	GP-91	GP-91 SNG	GA-291	GG-291	GAC-2349
2010	L4-1.6L	GP-291		GA-391	GG-291	
2009 - 2002	L4-1.6L	GP-291		GA-291	GG-291	GAC-4
2006 - 2002	L4-2.0L	GP-291		GA-391	GG-291	

DUSTER





2020	L4-2.0L			GA-2313		
2019 - 2016	L4-2.0L	GP-291		GA-291, GA-2313		
2017 - 2016	L4-2.0L	GP-291		GA-291, GA-2313	GG-291	
2015 - 2013	L4-2.0L	GP-291		GA-291		GAC-2348
2015 - 2013	L4-2.0L	GP-291		GA-291	GG-291	GAC-2348

EURO CLIO

2008 - 2007	L4-1.6L	GP-291			GG-291	
-------------	---------	--------	--	--	--------	--

FLUENCE

2017 - 2011	L4-2.0L	GP-91	GP-91 SNG	GA-292, GA-2214	GG-291	
-------------	---------	-------	-----------	--------------------	--------	--

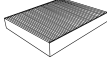
GONHER		ACEITE	SINTÉTICO	AIRE	COMB.	CABINA
AÑO	MOTOR					

RENAULT (Continúa)

KANGOO

2020 - 2019	L4-1.6L	GP-291		GA-2313		
2009 - 2007	L4-1.6L	GP-291		GA-291	GG-291	GAC-4

KANGOO EXPRESS

2017	L4-1.6L	GP-291		GA-291		
2016 - 2004	L4-1.6L	GP-291		GA-291	GG-291	
2010 - 2009	L4-1.5L Turbo diésel	GP-291		GA-291		

KOLEOS

2020 - 2018	L4-2.5L					GAC-2350
2017 - 2016	L4-2.5L	GP-91	GP-91 SNG	GAD-117		GAC-2350
2015 - 2009	L4-2.5L	GP-91	GP-91 SNG	GAD-117		

KWID

2021	L3-1.0L					GAC-2347
2020 - 2019	L3-1.0L	GP-2307 ⁽¹⁾		GA-2322		GAC-2347

LAGUNA

2006 - 2003	V6-2.9L	GP-291				
-------------	---------	--------	--	--	--	--

LOGAN

2019	L4-1.6L					GAC-2349
2018	L4-1.6L	GP-291		GA-291		GAC-2349
2017 - 2015	L4-1.6L	GP-291		GA-291	GG-291	GAC-2349

MEGANE

2010 - 2008	L4-1.6L	GP-291		GA-292		
2010 - 2003	L4-2.0L	GP-291		GA-292	GG-291	
2009 - 2007	L4-2.0L Turbo	GP-291		GA-292	GG-291	
2005	L4-2.0L Turbo	GP-291		GA-292	GG-291	
2002 - 2001	L4-2.0L	GP-291		GA-2121	GG-291	GAC-4

OROCH

2020 - 2019	L4-2.0L	GP-291		GA-2313		
-------------	---------	--------	--	---------	--	--

SANDERO

2019	L4-1.6L					GAC-2349
2018 - 2017	L4-1.6L	GP-291		GA-291, GA-525		GAC-2349
2017 - 2016	L4-2.0L	GP-291		GA-291		
2015 - 2013	L4-1.6L	GP-291		GA-291, GA-525	GG-291	GAC-2349
2014 - 2013	L4-1.6L					GAC-2349
2012 - 2010	L4-1.6L	GP-291		GA-291, GA-525	GG-291	

SCALA

2012 - 2011	L4-1.6L	GP-91	GP-91 SNG			
-------------	---------	-------	-----------	--	--	--

SCENIC

2004 - 2001	L4-2.0L	GP-291		GA-291	GG-291	
-------------	---------	--------	--	--------	--------	--

SCENIC II





2008 - 2005	L4-2.0L	GP-291		GA-391	GG-291	
-------------	---------	--------	--	--------	--------	--

STEPWAY

2020 - 2017	L4-1.6L	GP-291		GA-2313		
2016	L4-1.6L	GP-291		GA-2313	GG-291	
2015 - 2013	L4-1.6L	GP-291		GA-291	GG-291	GAC-2348
2012 - 2011	L4-1.6L	GP-291		GA-291	GG-291	

(1) Nuevo

Los filtros Gonher prolongan la vida útil del motor evitando el desgaste prematuro.
Para vehículos anteriores a 1990, consulte nuestro catálogo web en www.grupogonher.com

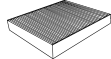
GONHER.		ACEITE	SINTÉTICO	AIRE	COMB.	CABINA
AÑO	MOTOR					

RENAULT (Continúa)

STEPWAY (Continúa)

2010	L4-1.6L	GP-291		GA-291		
------	---------	--------	--	--------	--	--

TRAFIC

2011 - 2010	L4-1.9L Turbo diésel			GA-4319	G-229	
2009 - 2007	L4-1.9L Turbo diésel	GP-291		GA-4319	G-229	

ROVER

75

2005-2003	V6-2.5L	GP-453		GA-2135		
2000	V6-2.5L	GP-453		GA-2135		

SAAB

9-3

2009-2007	L4-2.0L Turbo	G-49		GA-646		GAC-18
2009	V6-2.8L Turbo	G-49		GA-646		GAC-18
2006-2004	L4-2.0L Turbo	G-49		GA-646		
2003	L4-2.0L Turbo	G-49		GA-2118		
2002-2001	L4-2.0L Turbo	GP-58	GP-58 SNG	GA-2118		

9-4X

2011	V6-2.8L Turbo					GAC-32
2011	V6-3.0L					GAC-32

9-5

2011 - 2010	V6-2.8L Turbo				GG-246	GAC-32
2005-2004	L4-2.3L Turbo					
2003-2001	L4-2.3L Turbo	GP-58	GP-58 SNG			
2002	V6-3.0L	GP-58	GP-58 SNG			
2001	V6-3.0L Turbo	GP-58	GP-58 SNG			

SATURN

AURA

2009-2008	L4-2.4L			GA-367		
2009-2007	V6-3.6L			GA-367		
2009	L4-2.4L Híbrido			GA-367		
2008-2007	V6-3.5L			GA-367		
2007	L4-2.4L Híbrido	G-49		GA-367		

ION

2007-2006	L4-2.2L	G-49		GA-486		
2007-2006	L4-2.4L			GA-486		
2007-2004	L4-2.0L			GA-414R		
2005-2003	L4-2.2L	G-49				

L300

2005-2001	V6-3.0L	G-45				
-----------	---------	------	--	--	--	--

LW200





2003	L4-2.2L	G-49			GG-581	
------	---------	------	--	--	--------	--

LW300

2003	V6-3.0L	G-45			GG-581	
------	---------	------	--	--	--------	--

VUE

2009-2008	L4-2.4L			GA-290		
2009-2008	V6-3.5L			GA-290		
2009-2008	V6-3.6L			GA-290		

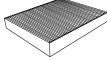
GONHER		ACEITE	SINTÉTICO	AIRE	COMB.	CABINA
AÑO	MOTOR					

SATURN (Continúa)

VUE (Continúa)

2008	L4-2.4L Híbrido			GA-290		
2007-2004	V6-3.5L			GA-367		
2007-2002	L4-2.2L			GA-367		
2007	L4-2.4L Híbrido			GA-367		
2003-2002	V6-3.0L	G-45		GA-367		

SEAT

ALHAMBRA

2008-2007	V6-2.8L	G-466, G-8530		GAVW-1197 ⁽¹⁾	GG-251	
2007-2004	L4-1.8L Turbo	GP-28, G-8530	GP-28 SNG	GAVW-1197 ⁽¹⁾	GG-251	
2005-2002	V6-2.8L	G-8530		GAVW-1197 ⁽¹⁾		
2003	L4-1.8L Turbo	GP-28, G-8530	GP-28 SNG	GAVW-1197 ⁽¹⁾		
2002	L4-1.8L	GP-28, G-8530	GP-28 SNG	GAVW-1197 ⁽¹⁾		

ALTEA

2012-2010	L4-1.4L Turbo	GP-561				
2006	L4-2.0L	G-313		GAVW-625	GG-355	GAC-28
2005	L4-2.0L	G-313		GAVW-625	GG-355	

ALTEA XL

2015	L4-1.8L Turbo	GP-407		GAVW-619	GG-107	GAC-28
2014-2013	L4-1.8L Turbo					GAC-28
2012	L4-1.8L Turbo	GP-561				
2010	L4-1.8L Turbo			GAVW-619		

ARONA

2020	L4-1.6L	GP-58	GP-58 SNG	GAVW-2941 ⁽¹⁾		GAC-60
2019-2018	L4-1.6L	GP-58	GP-58 SNG	GAVW-2941		GAC-60

ATECA

2018-2017	L4-1.4L Turbo	GP-503		GAVW-692		GAC-60
-----------	---------------	--------	--	----------	--	--------

CORDOBA

2009	L4-1.6L	GP-428		GAVW-623		GAC-60
2009	L4-2.0L	GP-28	GP-28 SNG	GAVW-624		GAC-60
2008-2006	L4-1.6L	GP-428		GAVW-623	GG-107	GAC-60
2008-2006	L4-2.0L	GP-28	GP-28 SNG	GAVW-624		GAC-3
2005-2004	L4-1.6L	GP-428		GAVW-623	GG-355	GAC-60
2005-2003	L4-2.0L	GP-28	GP-28 SNG	GAVW-624	GG-355	GAC-3
2002	L4-1.6L	GP-28	GP-28 SNG	GA-285	GG-355	GAC-60
2001	L4-1.6L	GP-28	GP-28 SNG	GA-285	GG-355	

EXEO

2011	L4-2.0L Turbo	G-313		GA-2124		
------	---------------	-------	--	---------	--	--

FREETRACK





2015	L4-2.0L Turbo	GP-407		GAVW-619		
2011-2010	L4-2.0L Turbo			GAVW-619		

IBIZA

2020-2018	L4-1.6L	GP-58	GP-58 SNG	GAVW-2941 ⁽¹⁾		GAC-60
2017-2016	L4-1.2L Turbo	GP-503		GAVW-692		
2017	L4-1.6L	GP-503		GAVW-2941 ⁽¹⁾		GAC-60

(1) Nuevo

Los filtros Gonher prolongan la vida útil del motor evitando el desgaste prematuro.
Para vehículos anteriores a 1990, consulte nuestro catálogo web en www.grupogonher.com

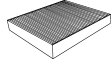
GONHER.		ACEITE	SINTÉTICO	AIRE	COMB.	CABINA
AÑO	MOTOR					

SEAT (Continúa)

IBIZA (Continúa)

2016	L4-1.6L	GP-503		GAVW-2941 ⁽¹⁾	GG-107	GAC-60
2015 - 2013	L4-1.2L Turbo	GP-561		GAVW-690	GG-1243	
2015 - 2010	L4-1.6L	G-562		GAVW-630	GG-107	GAC-60
2015	L4-1.4L Turbo	GP-561				
2015	L4-2.0L	GP-28, G-362	GP-28 SNG	GAVW-624	GG-107	GAC-60
2014 - 2009	L4-2.0L	GP-28	GP-28 SNG	GAVW-624	GG-107	GAC-60
2013	L4-1.4L Turbo	GP-561				
2012 - 2011	L4-1.4L Turbo	GP-561		GAVW-690		
2009-2006	L4-1.6L	GP-28	GP-28 SNG	GAVW-623	GG-107	GAC-60
2008	L4-1.8L Turbo	GP-28	GP-28 SNG	GAVW-624		GAC-3
2008	L4-2.0L	GP-28	GP-28 SNG	GAVW-624	GG-107	GAC-3
2007-2006	L4-2.0L	GP-28	GP-28 SNG	GAVW-624		GAC-3
2007-2005	L4-1.8L Turbo	GP-28	GP-28 SNG	GAVW-624	GG-106	GAC-3
2005-2004	L4-1.6L	GP-28	GP-28 SNG	GAVW-623	GG-355	GAC-60
2005-2003	L4-2.0L	GP-28	GP-28 SNG	GAVW-624	GG-355	GAC-3
2002 - 2001	L4-1.6L	GP-28	GP-28 SNG	GA-285	GG-355	GAC-60

LEON

2018 - 2015	L4-1.4L Turbo	GP-503		GAVW-692		
2018 - 2015	L4-1.4L Turbo	GP-503		GAVW-692		GAC-60
2018	L4-2.0L Turbo	G-784				GAC-60
2017 - 2016	L4-2.0L Turbo	G-784		GAVW-619		GAC-60
2017	L4-1.8L Turbo	GP-28	GP-28 SNG	GAVW-619		
2017	L4-2.0L Turbo	G-784		GAVW-619		
2016 - 2015	L4-1.8L Turbo	GP-407		GAVW-619	GG-1243	GAC-28
2015	L4-2.0L Turbo	G-313		GAVW-617	GG-1243	
2014	L4-1.8L Turbo	GP-28	GP-28 SNG	GAVW-619		GAC-28
2013 - 2011	L4-1.4L Turbo	GP-561				
2013 - 2011	L4-2.0L Turbo	GP-28	GP-28 SNG	GAVW-629		GAC-28
2013	L4-1.8L Turbo	GP-28	GP-28 SNG	GAVW-625		GAC-28
2012 - 2011	L4-1.8L Turbo	GP-28	GP-28 SNG	GAVW-621		
2010 - 2009	L4-2.0L Turbo	G-313		GAVW-629		GAC-28
2010	L4-1.4L Turbo	GP-428			GG-107	
2010	L4-1.8L Turbo			GAVW-619		
2009-2008	L4-1.4L Turbo	G-562		GAVW-629	GG-107	
2009	L4-1.8L Turbo			GAVW-621		
2008-2007	L4-2.0L	G-313		GAVW-629		GAC-28
2008-2007	L4-2.0L Turbo	G-313		GAVW-629	GG-1243	GAC-28
2007	L4-1.6L	GP-28	GP-28 SNG	GAVW-629		
2006	L4-1.8L Turbo	GP-28	GP-28 SNG	GAVW-621	GG-102	
2006	L4-2.0L					GAC-28
2005 - 2001	L4-1.8L	GP-28	GP-28 SNG	GAVW-621	GG-102	GAC-3
2005 - 2001	L4-1.8L Turbo	GP-28	GP-28 SNG	GAVW-621	GG-102	GAC-3

NUEVO IBIZA





2010	L4-1.6L	G-562		GAVW-630	GG-107	
2010	L4-2.0L	GP-28	GP-28 SNG	GAVW-624	GG-107	

TOLEDO

2019	L4-1.4L Turbo	GP-503				
2019	L4-1.6L	GP-561		GAVW-630		
2018 - 2017	L4-1.4L Turbo	GP-503		GAVW-692		
2018 - 2017	L4-1.6L	GP-561		GAVW-630		GAC-60
2018 - 2016	L4-1.4L Turbo	GP-503		GAVW-692		GAC-60
2017 - 2016	L4-1.2L Turbo	GP-503		GAVW-692		GAC-60

(1) Nuevo

Los filtros Gonher prolongan la vida útil del motor evitando el desgaste prematuro.
Para vehículos anteriores a 1990, consulte nuestro catálogo web en www.grupogonher.com

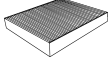
GONHER		ACEITE	SINTÉTICO	AIRE	COMB.	CABINA
AÑO	MOTOR					

FILTROS

SEAT

SEAT (Continúa)

TOLEDO (Continúa)

2017	L4-1.2L Turbo	GP-503		GAVW-692		
2017	L4-1.6L	GP-561		GAVW-630		
2016 - 2015	L4-1.6L	GP-561		GAVW-630	GG-107	
2016 - 2015	L4-1.6L	GP-561		GAVW-630	GG-107	GAC-60
2015	L4-1.2L Turbo	GP-561		GAVW-690		GAC-60
2015	L4-1.4L Turbo	GP-561		GAVW-690		GAC-60
2013	L4-1.2L Turbo	GP-561		GAVW-690		GAC-60
2013	L4-1.4L Turbo	GP-561		GAVW-690		GAC-60
2013	L4-1.6L	GP-561				GAC-60
2013	L4-1.6L	GP-561				GAC-60
2006	L4-2.0L	G-313		GAVW-625		
2005 - 2001	L4-1.8L	GP-28	GP-28 SNG	GAVW-621	GG-102	GAC-10 ⁽⁶⁾ , GAC-8
2004 - 2001	L4-1.8L Turbo	GP-28	GP-28 SNG	GAVW-621	GG-102	GAC-10 ⁽⁶⁾ , GAC-8

SMART

CABRIO

2005-2004	L3-0.7L Turbo	GP-28	GP-28 SNG	GAVW-621	GG-102	
-----------	---------------	-------	-----------	----------	--------	--

CROSSBLADE

2004	L3-0.6L Turbo			GA-2136		
------	---------------	--	--	---------	--	--

FORTWO

2018	L3-0.9L Turbo	GP-291				
2018	L3-1.0L	GP-291				
2014 - 2012	L3-1.0L Turbo	GP-91	GP-91 SNG			
2014 - 2008	L3-1.0L	GP-91	GP-91 SNG			
2010 - 2008	L3-1.0L Turbo	GP-91	GP-91 SNG			
2007 - 2006	L3-0.7L Turbo			GA-2136		
2005	L3-0.7L Turbo			GA-2136	GG-291	

ROADSTER

2004	L3-0.7L Turbo			GA-2136	GG-291	
------	---------------	--	--	---------	--------	--

SUBARU

ASCENT

2021	H4-2.4L Turbo			GA-2344		
2019	H4-2.4L Turbo	GP-149	GP-149 SNG			

B9 TRIBECA

2007 - 2006	H6-3.0L	GP-6811	GP-6811 SNG	GA-546		
-------------	---------	---------	-------------	--------	--	--





BAJA

2006 - 2005	H4-2.5L	GP-91	GP-91 SNG	GAD-15		
2006 - 2005	H4-2.5L Turbo	GP-91	GP-91 SNG	GAD-15		
2004	H4-2.5L	GP-91	GP-91 SNG			
2004	H4-2.5L Turbo	GP-91	GP-91 SNG			
2003	H4-2.5L	GP-149	GP-149 SNG			

BRZ

2020 - 2013	H4-2.0L	GP-6811	GP-6811 SNG	GA-263		
-------------	---------	---------	-------------	--------	--	--

(6) Con carbón activado

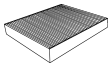
GONHER.		ACEITE	SINTÉTICO	AIRE	COMB.	CABINA
AÑO	MOTOR					

SUBARU (Continúa)

CROSSTREK

2021	H4-2.0L			GA-2344		
2021	H4-2.0L Híbrido			GA-2344		
2021	H4-2.5L			GA-2344		
2019 - 2018	H4-2.0L	GP-149	GP-149 SNG			
2019	H4-2.0L Híbrido	GP-149	GP-149 SNG	GA-150		
2017	H4-2.0L	GP-149	GP-149 SNG	GA-546		
2016	H4-2.0L			GA-263, GA-546		
2016	H4-2.0L Híbrido	GP-149	GP-149 SNG	GA-150		

FORESTER

2021	H4-2.5L			GA-2344		
2019 - 2014	H4-2.5L	GP-149	GP-149 SNG	GA-546		
2018 - 2014	H4-2.0L Turbo	GP-149	GP-149 SNG	GA-546		
2013 - 2012	H4-2.5L Turbo	GP-149	GP-149 SNG	GA-546		
2013	H4-2.5L	GP-149	GP-149 SNG	GAD-15		
2012	H4-2.5L	GP-149	GP-149 SNG	GA-546		
2011	H4-2.5L	GP-6811	GP-6811 SNG	GA-546		
2011	H4-2.5L Turbo	GP-6811	GP-6811 SNG	GA-546		
2010 - 2009	H4-2.5L	GP-91	GP-91 SNG	GA-546		
2010 - 2009	H4-2.5L Turbo	GP-91	GP-91 SNG	GA-546		
2008	H4-2.5L Turbo	GP-91	GP-91 SNG	GAD-15		
2007	H4-2.5L	GP-91	GP-91 SNG	GAD-15		
2006 - 1998	H4-2.5L	GP-149	GP-149 SNG	GAD-15		

IMPREZA

2021	H4-2.0L			GA-2344		
2017	H4-2.0L	GP-149	GP-149 SNG			
2016 - 2012	H4-2.0L	GP-149	GP-149 SNG	GA-546		
2014 - 2012	H4-2.5L Turbo	GP-149	GP-149 SNG	GA-546		
2011 - 2008	H4-2.5L	GP-91	GP-91 SNG	GA-546		
2011 - 2008	H4-2.5L Turbo	GP-91	GP-91 SNG	GA-546		
2007	H4-2.5L Turbo	GP-91	GP-91 SNG	GAD-15		
2006 - 2005	H4-2.5L	GP-91	GP-91 SNG	GAD-15		
2006 - 2004	H4-2.5L Turbo	GP-91	GP-91 SNG			
2004 - 2000	H4-2.5L	GP-149	GP-149 SNG			
2001 - 1995	H4-2.2L	GP-149	GP-149 SNG	GAD-15		
1999 - 1998	H4-2.5L	GP-149	GP-149 SNG	GAD-15		
1997 - 1993	H4-1.8L	GP-149	GP-149 SNG	GAD-15		





JUSTY

1994 - 1990	L3-1.2L	GP-91	GP-91 SNG	GAD-3		
-------------	---------	-------	-----------	-------	--	--

LEGACY

2021	H4-2.4L Turbo			GA-2344		
2021	H4-2.5L			GA-2344		
2019 - 2016	H6-3.6L	GP-6811	GP-6811 SNG			
2015	H4-2.5L	GP-149	GP-149 SNG	GA-546		
2015	H6-3.6L	GP-149	GP-149 SNG	GA-546		
2014 - 2013	H4-2.5L	GP-149	GP-149 SNG	GA-546		GAC-19
2014	H6-3.6L	GP-149	GP-149 SNG	GA-546		GAC-19
2013	H4-2.5L Turbo	GP-149	GP-149 SNG	GA-546		
2012 - 2010	H4-2.5L	GP-91	GP-91 SNG	GA-546		GAC-19
2012 - 2010	H4-2.5L Turbo	GP-91	GP-91 SNG	GA-546		GAC-19
2009 - 2008	H6-3.0L	GP-149	GP-149 SNG	GA-546		
2009	H4-2.5L	GP-91	GP-91 SNG	GA-546		
2007 - 2006	H4-2.5L	GP-91	GP-91 SNG	GA-546		

Los filtros Gonher prolongan la vida útil del motor evitando el desgaste prematuro.
Para vehículos anteriores a 1990, consulte nuestro catálogo web en www.grupogonher.com

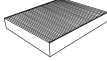
GONHER		ACEITE	SINTÉTICO	AIRE	COMB.	CABINA
AÑO	MOTOR					

SUBARU (Continúa)

LEGACY (Continúa)

2007 - 2006	H4-2.5L Turbo	GP-91	GP-91 SNG	GA-546		
2005	H4-2.5L	GP-91	GP-91 SNG			
2005	H4-2.5L Turbo	GP-91	GP-91 SNG			

OUTBACK

2021	H4-2.4L Turbo			GA-2344		
2021	H4-2.5L			GA-2344		
2018 - 2015	H4-2.5L					GAC-19
2017	H4-2.5L	GP-149	GP-149 SNG	GA-546		GAC-19
2017	H6-3.6L	GP-6811	GP-6811 SNG	GA-546		
2015 - 2013	H4-2.5L	GP-149	GP-149 SNG	GA-546		GAC-19
2015	H6-3.6L	GP-6811	GP-6811 SNG	GA-546		
2014 - 2010	H6-3.6L	GP-6811	GP-6811 SNG	GA-546		GAC-19
2012 - 2010	H4-2.5L	GP-91	GP-91 SNG	GA-546		GAC-19
2009	H4-2.5L	GP-91	GP-91 SNG	GA-546		
2008-2006	H4-2.5L Turbo	GP-91	GP-91 SNG	GA-546		
2005-2001	H6-3.0L	GP-149	GP-149 SNG			
2005-2000	H4-2.5L	GP-149	GP-149 SNG			
2005	H4-2.5L Turbo	GP-149	GP-149 SNG			

SVX

1997 - 1992	H6-3.3L	GP-149	GP-149 SNG	GAD-15		
-------------	---------	--------	------------	--------	--	--

TRIBECA

2014 - 2011	H6-3.6L	GP-6811	GP-6811 SNG	GA-546		
2010 - 2008	H6-3.6L	GP-149	GP-149 SNG	GA-546		

WRX

2020 - 2018	H4-2.0L Turbo	GP-6811	GP-6811 SNG			
2020	H4-2.0L	GP-6811	GP-6811 SNG			
2019 - 2015	H4-2.0L Turbo	GP-6811	GP-6811 SNG	GA-546		
2015 - 2014	H4-2.5L Turbo	GP-91	GP-91 SNG	GA-546		
2013 - 2012	H4-2.5L Turbo	GP-149	GP-149 SNG	GA-546		

WRX STI

2019	H4-2.5L Turbo	GP-91	GP-91 SNG	GA-546		
2018	H4-2.5L Turbo	GP-6811	GP-6811 SNG	GA-546		
2017	H4-2.5L Turbo	GP-91	GP-91 SNG	GA-546		

XV

2016 - 2013	H4-2.0L	GP-149	GP-149 SNG	GA-546		
-------------	---------	--------	------------	--------	--	--

XV CROSSTREK

2015 - 2014	H4-2.0L Híbrido	GP-149	GP-149 SNG	GA-150		
2015 - 2013	H4-2.0L	GP-149	GP-149 SNG	GA-546		

SUZUKI





AERIO

2007-2004	L4-2.3L	GP-156	GP-156 SNG	GA-242		
2003	L4-2.0L	GP-156	GP-156 SNG	GA-242		
2002	L4-2.0L	GP-156	GP-156 SNG			

CIAZ

2018	L4-1.4L	GP-156	GP-156 SNG	GA-2224		
2017 - 2016	L4-1.4L	GP-156	GP-156 SNG	GA-2224 ⁽¹⁾		

(1) Nuevo

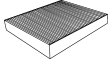
GONHER		ACEITE	SINTÉTICO	AIRE	COMB.	CABINA
AÑO	MOTOR					

SUZUKI (Continúa)

EQUATOR

2012 - 2009	L4-2.5L	GP-91	GP-91 SNG	GA-1546		
2012 - 2009	V6-4.0L	GP-149	GP-149 SNG	GA-300		

ERTIGA

2020 - 2019	L4-1.5L	GP-157				
-------------	---------	--------	--	--	--	--

ESTEEM

2002 - 1999	L4-1.8L	GP-156	GP-156 SNG			
2000 - 1995	L4-1.6L	GP-58	GP-58 SNG			

FORENZA

2008-2004	L4-2.0L	GP-46		GA-328		
-----------	---------	-------	--	--------	--	--

GRAND VITARA

2017 - 2011	L4-2.4L	GP-156	GP-156 SNG	GA-327		
2010 - 2009	L4-2.4L	GP-157		GA-327		
2010 - 2009	V6-3.2L	GP-406	GP-406 SNG	GA-327		
2008-2006	V6-2.7L	GP-2951		GA-243		
2005 - 1999	V6-2.5L	GP-2951		GA-244	GG-206	
2001	V6-2.7L	GP-2951		GA-244		

KIZASHI

2016 - 2010	L4-2.4L	GP-156	GP-156 SNG			
-------------	---------	--------	------------	--	--	--

RENO

2008 - 2005	L4-2.0L	GP-46		GA-328		
-------------	---------	-------	--	--------	--	--

SAMURAI

1995 - 1990	L4-1.3L	GP-156	GP-156 SNG		GG-7196	
-------------	---------	--------	------------	--	---------	--

S-CROSS

2018 - 2017	L4-1.6L	GP-157				
2016	L4-1.6L	GP-157		GAD-15		
2015 - 2014	L4-1.6L	GP-157				





SIDEKICK

1998 - 1996	L4-1.8L	GP-156	GP-156 SNG	GA-244	GG-151	
1998	L4-1.6L	GP-58	GP-58 SNG	GA-7617	GG-151	
1997 - 1996	L4-1.6L	GP-58	GP-58 SNG	GA-166, GA-7617	GG-151	
1995	L4-1.6L	GP-156	GP-156 SNG	GA-166, GA-7617	GG-151	
1994 - 1992	L4-1.6L	GP-2951 USA		GA-166, GA-7617	GG-151	
1991 - 1990	L4-1.6L	GP-2951 USA		GA-166	GG-151	

SWIFT

2020	L4-1.4L Turbo	GP-156	GP-156 SNG	GA-137		
2017 - 2013	L4-1.6L	GP-156	GP-156 SNG	GA-137		
2017 - 2012	L4-1.4L	GP-156	GP-156 SNG	GA-137		
2011 - 2009	L4-1.5L	GP-156	GP-156 SNG	GA-333		GAC-2278 ⁽¹⁾
2008-2007	L4-1.5L	GP-156	GP-156 SNG	GA-333		
2001	L4-1.3L	GP-156	GP-156 SNG	GA-142		
2000	L4-1.3L	GP-58	GP-58 SNG	GA-142		
1999 - 1995	L4-1.3L	GP-58	GP-58 SNG	GA-142	GG-146	
1994 - 1990	L4-1.3L	GP-2951		GA-142	GG-146	

(1) Nuevo

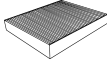
GONHER		ACEITE	SINTÉTICO	AIRE	COMB.	CABINA
AÑO	MOTOR					

FILTROS

SUZUKI

SUZUKI (Continúa)

SX4

2014 - 2010	L4-2.0L	GP-156	GP-156 SNG	GA-150		
2009-2008	L4-2.0L	GP-156	GP-156 SNG	GA-331		

VERONA

2006-2004	L6-2.5L	GP-461				
-----------	---------	--------	--	--	--	--

VITARA

2020 - 2017	L4-1.4L Turbo	GP-157				
2020 - 2016	L4-1.6L	GP-156	GP-156 SNG			
2004	V6-2.5L	GP-2951		GA-244	GG-206	
2003-1999	L4-2.0L	GP-156	GP-156 SNG	GA-244	GG-206	
2001 - 1999	L4-1.6L	GP-156	GP-156 SNG	GA-244	GG-206	

X-90

1998 - 1996	L4-1.6L	GP-58	GP-58 SNG	GA-7617	GG-151	
-------------	---------	-------	-----------	---------	--------	--

XL-7

2009-2007	V6-3.6L	GP-406	GP-406 SNG	GA-367		
2006-2002	V6-2.7L	GP-2951		GA-244		

TOYOTA

4RUNNER

2020 - 2013	V6-4.0L					GAC-19
2012 - 2010	V6-4.0L	GP-58	GP-58 SNG	GA-380		GAC-19
2010	L4-2.7L	GP-58	GP-58 SNG	GA-1780		
2009-2008	V6-4.0L	GP-58	GP-58 SNG	GA-380		
2008-2003	V8-4.7L	GP-58	GP-58 SNG	GA-286		GAC-2294 ⁽¹⁾
2007-2006	V6-4.0L	GP-58	GP-58 SNG	GA-380		GAC-2294 ⁽¹⁾
2005-2003	V6-4.0L	GP-58	GP-58 SNG	GA-380		
2002 - 1996	V6-3.4L	GP-58	GP-58 SNG	GA-7626	GG-187	
2000 - 1996	L4-2.7L	GP-58	GP-58 SNG	GA-6690		
1995 - 1990	L4-2.4L	GP-58	GP-58 SNG	GA-6690		
1995 - 1990	V6-3.0L	GP-58	GP-58 SNG	GA-139	GG-187	

86

2019 - 2017	H4-2.0L	GP-6811	GP-6811 SNG	GA-263		
-------------	---------	---------	-------------	--------	--	--

AVALON

2020	V6-3.5L			GA-2317		
2019	V6-3.5L	G-912		GA-478, GA-2317		
2018 - 2010	V6-3.5L	G-912		GA-478		
2009-2005	V6-3.5L	G-912		GA-320		GAC-19
2004-2000	V6-3.0L	GP-58	GP-58 SNG	GA-322		GAC-2294 ⁽¹⁾
1999 - 1998	V6-3.0L	GP-58	GP-58 SNG	GA-322		
1997 - 1995	V6-3.0L	GP-58	GP-58 SNG	GA-322	GG-185	

AVANZA





2020 - 2017	L4-1.5L	GP-157		GA-1500		
2016 - 2007	L4-1.5L	GP-157		GA-268		

CAMRY

2020 - 2019	L4-2.5L Híbrido			GA-2317		
2020	L4-2.5L			GA-2317		
2020	V6-3.5L			GA-2317		
2019 - 2018	L4-2.5L	GP-157		GA-2317		
2019 - 2018	L4-2.5L Híbrido	GP-157		GA-2317		

(1) Nuevo

Los filtros Gonher prolongan la vida útil del motor evitando el desgaste prematuro.
Para vehículos anteriores a 1990, consulte nuestro catálogo web en www.grupogonher.com

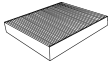
GONHER.		ACEITE	SINTÉTICO	AIRE	COMB.	CABINA
AÑO	MOTOR					

TOYOTA (Continúa)

CAMRY (Continúa)

2019 - 2018	V6-3.5L	G-912		GA-2317		
2018	L4-2.5L			GA-2317		
2017 - 2012	L4-2.5L Híbrido	G-912		GA-317		
2017 - 2012	V6-3.5L	G-912		GA-478		GAC-19
2017 - 2010	L4-2.5L	G-912		GA-464		GAC-19
2011 - 2007	L4-2.4L Híbrido	GP-156	GP-156 SNG	GA-264		GAC-19
2011 - 2007	V6-3.5L	G-912		GA-320		GAC-19
2009 - 2007	L4-2.4L	GP-156	GP-156 SNG	GA-464		GAC-19
2006 - 2004	L4-2.4L	GP-156	GP-156 SNG	GA-264		GAC-2294 ⁽¹⁾
2006 - 2004	V6-3.0L	GP-58	GP-58 SNG	GA-264		GAC-2294 ⁽¹⁾
2006 - 2004	V6-3.3L					GAC-2294 ⁽¹⁾
2003	L4-2.4L	GP-156	GP-156 SNG	GA-264		
2003	V6-3.0L	GP-58	GP-58 SNG	GA-264		
2002	L4-2.4L	GP-156	GP-156 SNG	GA-264		GAC-2294 ⁽¹⁾
2002	V6-3.0L	GP-58	GP-58 SNG	GA-264		GAC-2294 ⁽¹⁾
2001 - 1993	V6-3.0L	GP-58	GP-58 SNG	GA-264		
2001 - 1992	L4-2.2L	GP-157		GA-322	GG-185	
1991 - 1990	L4-2.0L	GP-157		GA-147	GG-185	
1991 - 1990	V6-2.5L	GP-58	GP-58 SNG	GA-195	GG-185	

CELICA

2005 - 2000	L4-1.8L	GP-157				
1999 - 1994	L4-2.2L				GG-164	
1997 - 1994	L4-1.8L	GP-157				
1993 - 1990	L4-1.6L	GP-157		GA-5125	GG-185	





C-HR

2020 - 2018	L4-2.0L	G-911				
-------------	---------	-------	--	--	--	--

COROLLA

2020 - 2019	L4-2.0L	GP-157				
2020	L4-1.8L			GA-2323		
2020	L4-1.8L	GP-157		GA-2323		
2019	L4-1.8L	GP-157		GA-265		GAC-19
2018 - 2016	L4-1.8L	G-911		GA-265		GAC-19
2015 - 2014	L4-1.8L	G-911		GA-320		GAC-19
2013 - 2012	L4-1.8L	G-911		GA-265		GAC-19
2012	L4-2.4L	GP-58	GP-58 SNG	GA-263		
2011 - 2009	L4-2.4L	GP-156	GP-156 SNG	GA-320		GAC-19
2011	L4-1.8L	G-911		GA-265		
2010	L4-1.8L	G-911		GA-320		
2009	L4-1.8L	G-911		GA-265		
2008 - 2007	L4-1.8L	GP-157		GA-263		GAC-2275 ⁽¹⁾
2006 - 2005	L4-1.8L	GP-156	GP-156 SNG	GA-263		GAC-2275 ⁽¹⁾
2004 - 2003	L4-1.8L	GP-157		GA-263		GAC-2275 ⁽¹⁾
2002	L4-1.8L	GP-157		GA-5466		GAC-2275 ⁽¹⁾
2001 - 1998	L4-1.8L	GP-157		GA-5466		
1997 - 1993	L4-1.6L			GA-5466	GG-220	
1997 - 1993	L4-1.8L	GP-157		GA-263	GG-220	
1997	L4-1.6L	GP-157		GA-5466		
1992	L4-1.6L	GP-157		GA-195		
1991 - 1990	L4-1.6L	GP-156, GP-157	GP-156 SNG	GA-195		

(1) Nuevo

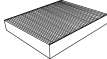
GONHER		ACEITE	SINTÉTICO	AIRE	COMB.	CABINA
AÑO	MOTOR					

TOYOTA (Continúa)

COROLLA IM

2018 - 2017	L4-1.8L	G-911, GP-157		GA-265		
-------------	---------	------------------	--	--------	--	--

CRESSIDA

1992 - 1990	L6-3.0L	GP-58	GP-58 SNG	GA-139	GG-7196	
-------------	---------	-------	-----------	--------	---------	--

ECHO

2005-2000	L4-1.5L	GP-157		GA-364		
-----------	---------	--------	--	--------	--	--

FJ CRUISER

2014 - 2011	V6-4.0L					GAC-2294 ⁽¹⁾
2010	V6-4.0L			GA-380		GAC-2294 ⁽¹⁾
2009-2008	V6-4.0L	GP-58	GP-58 SNG	GA-380		GAC-2294 ⁽¹⁾
2009	V6-4.0L	GP-58	GP-58 SNG	GA-380		

HIACE

2020	V6-3.5L	G-912				
2019 - 2017	L4-2.7L	GP-58	GP-58 SNG	GA-410		
2016 - 2014	L4-2.7L	GP-58	GP-58 SNG	GA-410	GG-103	GAC-19
2013 - 2006	L4-2.7L	GP-58	GP-58 SNG	GA-410	GG-103	

HIGHLANDER

2020	V6-3.5L			GA-2317		
2019 - 2014	L4-2.7L	G-912		GA-478		GAC-19
2019 - 2014	V6-3.5L	G-912		GA-478		GAC-19
2019 - 2014	V6-3.5L Híbrido	G-912				
2013 - 2009	L4-2.7L	G-912		GA-264		GAC-19
2013 - 2008	V6-3.5L	G-912		GA-264		GAC-19
2013	V6-3.5L Híbrido	G-912		GA-249		
2012	V6-3.5L Híbrido	G-912				
2011	V6-3.5L Híbrido	GP-58	GP-58 SNG	GA-264		
2010 - 2006	V6-3.3L Híbrido	GP-58	GP-58 SNG			
2007 - 2004	V6-3.3L	GP-58	GP-58 SNG	GA-264		
2007 - 2001	L4-2.4L	GP-156	GP-156 SNG	GA-264		
2003 - 2001	V6-3.0L	GP-58	GP-58 SNG	GA-264		





HILUX

2020 - 2019	L4-2.7L	GP-58	GP-58 SNG	GA-1781 ⁽¹⁾	GG-183	
2017	L4-2.7L	GP-58	GP-58 SNG	GA-1781 ⁽¹⁾	GG-183	
2016 - 2009	L4-2.7L	GP-58	GP-58 SNG	GA-412R		
2008 - 2006	L4-2.7L	GP-58	GP-58 SNG	GA-412R	GG-183	
2005 - 2004	L4-2.7L	GP-58	GP-58 SNG	GA-412R	GG-186	

LAND CRUISER

2020 - 2013	V8-5.7L	G-917		GA-393		GAC-19
2011 - 2008	V8-5.7L	G-917		GA-393		GAC-19
2007	V8-4.7L	GP-3600	GP-3600 SNG	GA-286		
2006 - 1998	V8-4.7L	GP-58	GP-58 SNG	GA-286		
1997	L6-4.5L	GP-58	GP-58 SNG			
1996	L6-4.5L	GP-1, GP-58	GP-58 SNG			
1995 - 1993	L6-4.5L	GP-1				
1992 - 1990	L6-4.0L	GP-1			GG-7196	

(1) Nuevo

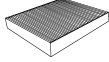
GONHER.		ACEITE	SINTÉTICO	AIRE	COMB.	CABINA
AÑO	MOTOR					
TOYOTA (Continúa)						

MATRIX

2013 - 2009	L4-1.8L	G-911		GA-265		
2013 - 2009	L4-2.4L	GP-156	GP-156 SNG	GA-320		GAC-19
2008	L4-1.8L	G-911		GA-263		GAC-2275 ⁽¹⁾
2007 - 2003	L4-1.8L	GP-157		GA-263		GAC-2275 ⁽¹⁾

MR2

1995 - 1991	L4-2.0L Turbo	GP-156	GP-156 SNG		GG-7196	
1995 - 1991	L4-2.2L	GP-157			GG-7196	

MR2 SPYDER

2006 - 2000	L4-1.8L	GP-157		GA-5125		
-------------	---------	--------	--	---------	--	--

PASEO

1998 - 1997	L4-1.5L	GP-157		GA-7167		
1996 - 1992	L4-1.5L	GP-157		GA-7167	GG-185	

PICKUP

1995 - 1993	L4-2.4L			GA-6690		
1995	V6-3.0L	GP-58	GP-58 SNG	GA-139		
1995	V6-3.0L	GP-58	GP-58 SNG	GA-139	GG-137	
1994 - 1990	V6-3.0L	GP-58	GP-58 SNG	GA-139	GG-187	
1992 - 1990	L4-2.4L	GP-58	GP-58 SNG	GA-6690		

PREVIA

1997 - 1991	L4-2.4L	GP-58	GP-58 SNG	GA-6690	GG-227	
-------------	---------	-------	-----------	---------	--------	--

PRIUS

2020 - 2016	L4-1.8L Híbrido			GA-2323		
2018 - 2016	L4-1.8L Híbrido	G-911		GA-2323		GAC-19
2015 - 2012	L4-1.8L Híbrido	G-911				GAC-19
2011 - 2010	L4-1.8L Eléctrico	G-911				
2009 - 2001	L4-1.5L Híbrido	GP-157				GAC-2294 ⁽¹⁾

PRIUS C

2020 - 2018	L4-1.5L Híbrido	GP-157		GA-2323		GAC-19
2017 - 2016	L4-1.5L Híbrido	GP-157		GA-2323		
2015 - 2012	L4-1.5L Híbrido			GA-2323		

PRIUS PLUG-IN

2015 - 2012	L4-1.8L Híbrido	G-911				
-------------	-----------------	-------	--	--	--	--

PRIUS PRIME

2020 - 2017	L4-1.8L Híbrido	G-911		GA-2323		
-------------	-----------------	-------	--	---------	--	--

PRIUS V





2017 - 2015	L4-1.8L Híbrido	G-911				
-------------	-----------------	-------	--	--	--	--

RAV4

2020 - 2019	L4-2.5L	GP-157		GA-2317		
2020 - 2019	L4-2.5L Híbrido			GA-2317		
2020	L4-2.5L	GP-157				
2018 - 2013	L4-2.5L	G-912		GA-317		GAC-19
2012 - 2009	L4-2.5L	G-912		GA-320		GAC-19
2012 - 2009	V6-3.5L	G-912		GA-320		GAC-19
2008 - 2006	L4-2.4L	GP-156	GP-156 SNG	GA-320		GAC-19
2007 - 2006	V6-3.5L	G-912		GA-320		GAC-19
2005 - 2004	L4-2.4L	GP-156	GP-156 SNG	GA-293		
2003	L4-2.0L	GP-157		GA-293		
2002 - 2001	L4-2.0L	GP-157		GA-293	GG-164	

(1) Nuevo

Los filtros Gonher prolongan la vida útil del motor evitando el desgaste prematuro.
Para vehículos anteriores a 1990, consulte nuestro catálogo web en www.grupogonher.com

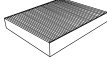
GONHER		ACEITE	SINTÉTICO	AIRE	COMB.	CABINA
AÑO	MOTOR					

TOYOTA (Continúa)

RAV4 (Continúa)

2000 - 1997	L4-2.0L	GP-157			GG-164	
1996	L4-2.0L	GP-157				

SEQUOIA

2021	V8-5.7L			GA-2352		
2020 - 2019	V8-5.7L					GAC-19
2018 - 2009	V8-5.7L	G-917		GA-393		GAC-19
2012 - 2010	V8-4.6L	G-917		GA-393		GAC-19
2009-2008	V8-4.7L	GP-58	GP-58 SNG	GA-393		GAC-19
2007-2001	V8-4.7L	GP-58	GP-58 SNG	GA-393		

SIENNA

2020 - 2011	V6-3.5L	G-912		GA-478		GAC-19
2012 - 2011	L4-2.7L	G-912		GA-478		
2010	V6-3.5L	G-912		GA-264		
2009-2007	V6-3.5L	G-912		GA-264		GAC-2294 ⁽¹⁾
2006-2004	V6-3.3L	GP-58	GP-58 SNG	GA-264		GAC-2294 ⁽¹⁾
2003-1998	V6-3.0L	GP-58	GP-58 SNG	GA-322		

SOLARA

2008-2004	L4-2.4L	GP-156	GP-156 SNG	GA-264		GAC-2294 ⁽¹⁾
2008-2004	V6-3.3L	GP-58	GP-58 SNG	GA-264		GAC-2294 ⁽¹⁾
2006-2005	V6-3.3L					GAC-2294 ⁽¹⁾
2003-2002	L4-2.4L	GP-156	GP-156 SNG	GA-322		
2003-1999	V6-3.0L	GP-58	GP-58 SNG	GA-322		
2001-1999	L4-2.2L	GP-157		GA-322	GG-185	

SUPRA

1998 - 1993	L6-3.0L	GP-58	GP-58 SNG			
1998 - 1993	L6-3.0L Turbo	GP-58	GP-58 SNG			
1992 - 1990	L6-3.0L	GP-58	GP-58 SNG	GA-139		
1992 - 1990	L6-3.0L Turbo	GP-58	GP-58 SNG	GA-139		





T100

1998 - 1995	V6-3.4L	GP-58	GP-58 SNG	GA-198		
1998 - 1994	L4-2.7L	GP-58	GP-58 SNG	GA-198		
1994 - 1993	V6-3.0L	GP-58	GP-58 SNG	GA-198		

TACOMA

2021	V6-3.5L			GA-2352		
2020-2005	L4-2.7L	GP-58	GP-58 SNG	GA-1780		
2020	V6-3.5L	G-912		GA-380		
2019 - 2018	V6-3.5L	G-912				
2017 - 2016	V6-3.5L	G-912		GA-380		
2015 - 2007	V6-4.0L	GP-58	GP-58 SNG	GA-380		
2006	V6-4.0L	GP-3600	GP-3600 SNG	GA-380		
2005	V6-4.0L	GP-58	GP-58 SNG	GA-380		
2004-1998	L4-2.7L	GP-58	GP-58 SNG			
2004-1995	L4-2.4L	GP-58	GP-58 SNG	GA-6690		
2004-1995	L4-2.7L	GP-58	GP-58 SNG	GA-6690		
2004-1995	V6-3.4L			GA-7626		
2000	V6-3.4L	GP-58	GP-58 SNG	GA-7626	GG-187	

(1) Nuevo

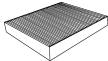
GONHER.		ACEITE 	SINTÉTICO 	AIRE 	COMB. 	CABINA 
AÑO	MOTOR					

TOYOTA (Continúa)

TERCEL

1998 - 1995	L4-1.5L	GP-157		GA-7167		
1994 - 1991	L4-1.5L	GP-157		GA-7167	GG-185	
1990	L4-1.5L	GP-157			GG-185	

TUNDRA

2021	V8-4.6L			GA-2352		
2021	V8-5.7L			GA-2352		
2019	V8-4.6L					GAC-19
2019	V8-5.7L					GAC-19
2018 - 2015	V8-4.6L	G-917				GAC-19
2018	V8-5.7L	G-917				GAC-19
2017	V8-5.7L	G-917		GA-393		GAC-19
2016 - 2014	V8-5.7L	G-917				GAC-19
2014 - 2010	V8-4.6L	G-917		GA-393		GAC-19
2014	V6-4.0L			GA-380		
2013 - 2012	V6-4.0L			GA-393		
2013 - 2007	V8-5.7L	G-917		GA-393		GAC-19
2011	V6-4.0L			GA-380		
2010	V6-4.0L	GP-58	GP-58 SNG	GA-380		
2009 - 2007	V8-4.7L	GP-58	GP-58 SNG	GA-393		GAC-19
2009 - 2005	V6-4.0L	GP-58	GP-58 SNG	GA-380		GAC-19
2009	V8-5.7L	G-917		GA-393		
2006 - 2005	V6-4.0L	GP-58	GP-58 SNG	GA-380		
2006 - 2000	V8-4.7L	GP-58	GP-58 SNG	GA-393		
2004 - 2000	V6-3.4L	GP-58	GP-58 SNG	GA-286	GG-187	

VENZA

2015 - 2010	L4-2.7L	G-912		GA-464		
2015 - 2010	V6-3.5L	G-912		GA-320		
2009	L4-2.7L	G-912		GA-464		GAC-19
2009	V6-3.5L	G-912		GA-320		GAC-19

YARIS

2016 - 2007	L4-1.5L	GP-157		GA-265		GAC-19
2006	L4-1.5L	GP-157		GA-265, GA-2230		
2005	L4-1.3L	GP-157		GA-364, GA-2230		
2005	L4-1.5L			GA-2230		
2004	L4-1.3L	GP-157		GA-364		

YARIS R

2021	L4-1.5L					
2019 - 2017	L4-1.5L	GP-157		GA-1084 ⁽¹⁾		

YARIS IA

2018 - 2017	L4-1.5L	GP-91	GP-91 SNG			
-------------	---------	-------	-----------	--	--	--





VOLKSWAGEN

AMAROK

2019	L4-2.0L Turbo diésel	GP-407		GAVW-1262		
2018	L4-2.0L Turbo diésel	GP-407		GAVW-1262 ⁽¹⁾		
2017 - 2011	L4-2.0L Turbo diésel	G-362 ⁽¹⁾		GAVW-1262 ⁽¹⁾		
2014 - 2013	L4-2.0L	GP-407				
2014 - 2013	L4-2.0L Turbo	GP-407				
2014	L4-2.0L Diésel	G-362 ⁽¹⁾		GAVW-1262 ⁽¹⁾		

(1) Nuevo

Los filtros Gonher prolongan la vida útil del motor evitando el desgaste prematuro.
Para vehículos anteriores a 1990, consulte nuestro catálogo web en www.grupogonher.com

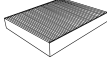
GONHER		ACEITE	SINTÉTICO	AIRE	COMB.	CABINA
AÑO	MOTOR					

VOLKSWAGEN (Continúa)

AMAROK (Continúa)

2012	L4-2.0L	GP-28	GP-28 SNG			
2012	L4-2.0L Turbo	GP-28	GP-28 SNG			
2011	L4-2.0L Diésel	G-362 ⁽¹⁾		GAVW-1262 ⁽¹⁾		

BEETLE

2019 - 2014	L4-2.0L Turbo	G-784		GAVW-619		
2018 - 2014	L4-2.0L Turbo	G-784		GAVW-619	GG-1243	GAC-28
2018	L5-2.5L					GAC-28
2017 - 2016	L5-2.5L	G-313		GAVW-625	GG-107	GAC-28
2015 - 2014	L4-1.8L Turbo	G-784		GAVW-619		
2015	L5-2.5L	G-313		GAVW-625	GG-102	GAC-28
2014 - 2013	L5-2.5L	G-313		GAVW-625		GAC-28
2013	L4-2.0L Turbo					GAC-28
2012	L4-2.0L Turbo	GP-28	GP-28 SNG	GAVW-621	GG-102	GAC-28
2012	L5-2.5L	G-313		GAVW-625	GG-102	GAC-28
2011 - 2010	L4-2.0L	GP-28	GP-28 SNG	GAVW-621	GG-102	GAC-10 ⁽⁶⁾ , GAC-8
2011 - 2008	L5-2.5L	G-313		GAVW-621	GG-102	
2009	L4-2.0L	GP-28	GP-28 SNG	GAVW-623		GAC-10 ⁽⁶⁾ , GAC-8
2008 - 2007	L4-2.0L	GP-28	GP-28 SNG	GAVW-623	GG-102	GAC-10 ⁽⁶⁾ , GAC-8
2006 - 1998	L4-1.9L Turbo diésel	G-8530 ⁽¹⁾				
2006	L4-2.0L	GP-28	GP-28 SNG	GAVW-621	GG-355	GAC-10 ⁽⁶⁾ , GAC-8
2005 - 2000	L4-1.8L Turbo	GP-28	GP-28 SNG	GAVW-621	GG-102	
2005 - 1998	L4-2.0L	GP-28	GP-28 SNG	GAVW-621	GG-102	GAC-10 ⁽⁶⁾ , GAC-8

BEETLE CABRIO

2011 - 2010	L5-2.5L	G-313		GAVW-621	GG-102	
-------------	---------	-------	--	----------	--------	--

BORA

2010 - 2007	L4-1.9L Turbo diésel	G-466		GAVW-619	G-434	
2010	L5-2.5L	G-313		GAVW-625	GG-107	
2009 - 2006	L4-2.0L Turbo	G-313		GAVW-629	GG-1243	GAC-28
2009 - 2006	L5-2.5L	G-313		GAVW-625	GG-107	GAC-28
2005	L5-2.5L	G-313		GAVW-625		

CABRIO

2002 - 1996	L4-2.0L	GP-28	GP-28 SNG	GAVW-121	GG-251	GAC-10 ⁽⁶⁾ , GAC-8
-------------	---------	-------	-----------	----------	--------	----------------------------------

CADDY

2019	L4-1.6L			GAVW-2941 ⁽¹⁾		
2018	L4-1.6L	GP-561		GAVW-630		
2017	L4-1.2L Turbo	GP-561		GAVW-630	GG-107	
2016 - 2015	L4-1.2L Turbo	GP-561		GAVW-629	GG-1243	GAC-28

CC

2017	L4-2.0L Turbo	GP-407		GAVW-619		
2016 - 2013	L4-2.0L Turbo	GP-407		GAVW-619		GAC-28
2016 - 2013	V6-3.6L			GAVW-618		GAC-28

CLASICO

2015 - 2011	L4-2.0L	GP-28	GP-28 SNG	GAVW-629	GG-102	
2012 - 2011	L4-1.8L Turbo	GP-28	GP-28 SNG	GAVW-629	GG-102	

(1) Nuevo, (6) Con carbón activado

GONHER.		ACEITE	SINTÉTICO	AIRE	COMB.	CABINA
AÑO	MOTOR					

VOLKSWAGEN (Continúa)

COMBI

2001 - 1990	L4-1.8L	GP-28	GP-28 SNG	GA-49	GG-251	
-------------	---------	-------	-----------	-------	--------	--

CRAFTER

2017	L4-2.0L Diésel			GAVW-651		
2017	L4-2.0L Turbo diésel			GAVW-651		
2016 - 2013	L4-2.0L Turbo diésel	G-362 ⁽¹⁾		GAVW-651		
2016	L4-2.0L Diésel	G-362 ⁽¹⁾		GAVW-651		
2012 - 2008	L5-2.5L Turbo diésel	G-8530 ⁽¹⁾		GAVW-651	G-7159	
2012	L4-2.0L Turbo diésel			GAVW-651		

CROSSFOX

2017	L4-1.6L	GP-503				GAC-60
2016 - 2011	L4-1.6L	GP-428		GAVW-623	GG-252	GAC-60
2009 - 2007	L4-1.6L	GP-428		GAVW-623	GG-252	GAC-3

DERBY

2009 - 2000	L4-1.8L	GP-28	GP-28 SNG	GA-285, GAVW-212	GG-106	
2003 - 2002	L4-2.0L	GP-28	GP-28 SNG	GAVW-212	GG-106	
1999	L4-1.8L	GP-28	GP-28 SNG	GAVW-212	GG-106	
1998 - 1995	L4-1.8L	GP-28	GP-28 SNG	GAVW-212	GG-251	

EOS

2015 - 2011	L4-2.0L Turbo	GP-406		GAVW-619		
2010	L4-2.0L Turbo	GP-407		GAVW-619	GG-1243	

EUROVAN

2009 - 2006	L4-1.9L Turbo diésel	G-466		GAVW-627	GP-857	
2004 - 2001	L5-2.5L	GP-310		GAVW-626	GG-251	
2000	V6-2.8L	G-112		GAVW-626	GG-251	

GLI

2010	L4-2.0L Turbo			GAVW-619	GG-1243	
------	---------------	--	--	----------	---------	--

GOL

2020	L4-1.6L	GP-561		GAVW-630		GAC-60
2019 - 2018	L4-1.6L	GP-428		GAVW-628		GAC-60
2017 - 2016	L4-1.6L	GP-428		GAVW-628	GG-291	GAC-60
2013 - 2009	L4-1.6L	GP-428		GAVW-628	GG-291	GAC-60

GOL SEDAN

2013 - 2010	L4-1.6L	GP-428		GAVW-628	GG-291	
-------------	---------	--------	--	----------	--------	--

GOLF

2019	L4-2.0L Turbo	G-784				
2018 - 2016	L4-1.4L Turbo	GP-503		GAVW-692		GAC-60
2015	L4-1.4L Turbo	GP-503		GAVW-692	GG-1243	GAC-60
2013	L4-1.4L Turbo	GP-561		GAVW-619	GG-1243	GAC-28
2012	L4-2.0L Turbo diésel	G-362 ⁽¹⁾				
2007	L4-2.0L	G-313		GAVW-621		GAC-10 ⁽⁶⁾ , GAC-8
2006 - 2000	L4-2.0L	GP-28	GP-28 SNG	GAVW-621	GG-102	GAC-10 ⁽⁶⁾ , GAC-8
2006 - 1999	L4-1.9L Turbo diésel	G-8530 ⁽¹⁾				GAC-10 ⁽⁶⁾ , GAC-8
2005 - 2001	L4-1.8L Turbo	GP-28	GP-28 SNG	GAVW-621	GG-102	
2003	V6-3.2L	G-466		GAVW-621		
1999 - 1995	L4-1.8L	GP-28	GP-28 SNG	GAVW-121	GG-251	GAC-10 ⁽⁶⁾ , GAC-8

(1) Nuevo, (6) Con carbón activado

Los filtros Gonher prolongan la vida útil del motor evitando el desgaste prematuro.

Para vehículos anteriores a 1990, consulte nuestro catálogo web en www.grupogonher.com

GONHER		ACEITE	SINTÉTICO	AIRE	COMB.	CABINA
AÑO	MOTOR					

FILTROS

VOLKSWAGEN

VOLKSWAGEN (Continúa)

GOLF (Continúa)

1999 - 1995	L4-2.0L	GP-28	GP-28 SNG	GAVW-121	GG-251	GAC-10 ⁽⁶⁾ , GAC-8
1999	V6-2.8L	G-112		GAVW-121	GG-251	
1998 - 1997	V6-2.8L	G-112		GAVW-120	GG-246	
1996	V6-2.8L	G-112		GAVW-121	GG-251	
1995	L4-2.0L			GA-476		
1994	L4-1.8L	GP-28	GP-28 SNG	GAVW-121	GG-239	GAC-10 ⁽⁶⁾ , GAC-8
1993	L4-1.8L	GP-28	GP-28 SNG	GAVW-121	GG-251	GAC-10 ⁽⁶⁾ , GAC-8
1992	L4-1.8L	GP-28	GP-28 SNG	GAVW-120	GG-251	
1991 - 1990	L4-1.8L	GP-28	GP-28 SNG	GAVW-10	GG-251	

GOLF R

2019 - 2015	L4-2.0L Turbo	G-784				
2013 - 2012	L4-2.0L Turbo	G-784				

GOLF SPORTWAGEN

2013	L5-2.5L	G-313		GAVW-625		GAC-28
2012 - 2010	L5-2.5L	G-313		GAVW-625	GG-107	GAC-28

GTI

2018	L4-2.0L Turbo			GAVW-619		
2016 - 2015	L4-2.0L Turbo					GAC-60
2013 - 2010	L4-2.0L Turbo	GP-407		GAVW-619		
2009	L4-2.0L Turbo	GP-407		GAVW-619		GAC-28
2008	L4-2.0L Turbo	GP-407		GAVW-617		GAC-28
2007	L4-2.0L Turbo	G-313		GAVW-617		GAC-28

JETTA

2020 - 2019	L4-2.0L Turbo	G-784				
2020 - 2018	L4-1.4L Turbo	GP-503		GAVW-692		GAC-60
2018 - 2011	L5-2.5L	G-313		GAVW-625	GG-107	GAC-28
2018	L4-2.0L	GP-28	GP-28 SNG	GAVW-619	GG-107	GAC-28
2018	L4-2.0L Turbo	G-784		GAVW-619		
2017	L4-2.0L	GP-28	GP-28 SNG	GAVW-629	GG-107	GAC-28
2017	L4-2.0L Turbo	GP-28	GP-28 SNG	GAVW-629	GG-107	GAC-28
2016 - 2015	L4-2.0L Turbo diésel	G-362 ⁽¹⁾ , G-466		GAVW-619		
2016	L4-2.0L	GP-28	GP-28 SNG	GAVW-619	GG-107	GAC-28
2016	L4-2.0L Turbo	GP-28	GP-28 SNG	GAVW-619	GG-107	GAC-28
2015 - 2014	L4-2.0L	GP-28	GP-28 SNG	GAVW-629	GG-107	GAC-10 ⁽⁶⁾ , GAC-8
2015	L4-2.0L Turbo			GAVW-619		GAC-28
2014 - 2013	L4-2.0L Turbo diésel	G-362 ⁽¹⁾ , G-466		GAVW-619	G-434	
2014	L4-2.0L Turbo	GP-407		GAVW-619	GG-107	GAC-28
2013	L4-2.0L	GP-28	GP-28 SNG	GAVW-629		GAC-10 ⁽⁶⁾ , GAC-8
2013	L4-2.0L Turbo	GP-407		GAVW-619		GAC-28
2012 - 2011	L4-2.0L Turbo diésel	G-362 ⁽¹⁾ , G-466		GAVW-619		
2012	L4-2.0L Turbo	GP-28, GP-407	GP-28 SNG	GAVW-629, GAVW-619		GAC-28
2010 - 2009	L4-1.8L Turbo	GP-28	GP-28 SNG	GAVW-621		GAC-10 ⁽⁶⁾ , GAC-8
2010	L4-1.9L Turbo diésel	GP-28	GP-28 SNG	GAVW-621	GG-102	GAC-10 ⁽⁶⁾ , GAC-8

(1) Nuevo, (6) Con carbón activado

Los filtros Gonher prolongan la vida útil del motor evitando el desgaste prematuro.
Para vehículos anteriores a 1990, consulte nuestro catálogo web en www.grupogonher.com

GONHER.		ACEITE	SINTÉTICO	AIRE	COMB.	CABINA
AÑO	MOTOR					

VOLKSWAGEN (Continúa)

JETTA (Continúa)

2010	L4-2.0L	GP-407		GAVW-619		GAC-10 ⁽⁶⁾ , GAC-8
2009-2008	L5-2.5L	G-313		GAVW-625	GG-107	GAC-28
2009-2007	L4-2.0L	GP-28	GP-28 SNG	GAVW-621	GG-102	
2009	L4-1.9L Turbo diésel	G-466		GAVW-621		GAC-10 ⁽⁶⁾ , GAC-8
2009	L4-2.0L Turbo	GP-407		GAVW-618		GAC-28
2009	L4-2.0L Turbo diésel	G-466		GAVW-619		
2008-2007	L4-2.0L Turbo	G-313, GP-407		GAVW-617	GG-1243	GAC-28
2008	L4-1.9L Turbo diésel	G-466		GAVW-618		GAC-10 ⁽⁶⁾ , GAC-8
2007	L4-1.9L Turbo diésel	G-466		GAVW-621		GAC-10 ⁽⁶⁾ , GAC-8
2006	L4-1.9L Turbo diésel	G-466		GAVW-621	G-434	GAC-10 ⁽⁶⁾ , GAC-8
2006	L4-2.0L	GP-28	GP-28 SNG	GAVW-621	GG-251	
2005-2000	L4-1.8L Turbo	GP-28	GP-28 SNG	GAVW-621	GG-102	GAC-10 ⁽⁶⁾ , GAC-8
2005-2000	L4-2.0L	GP-28	GP-28 SNG	GAVW-621	GG-102	
2005-1999	L4-1.9L Turbo diésel	G-8530 ⁽¹⁾				GAC-10 ⁽⁶⁾ , GAC-8
2002-2000	V6-2.8L	G-112		GAVW-621	GG-102	
1999-1995	V6-2.8L	G-112		GAVW-120	GG-246	
1999-1993	L4-1.8L	GP-28	GP-28 SNG	GAVW-121	GG-251	
1999-1993	L4-2.0L	GP-28	GP-28 SNG	GAVW-121	GG-251	
1999	L4-1.8L Turbo	GP-28	GP-28 SNG	GAVW-121	GG-251	GAC-10 ⁽⁶⁾ , GAC-8
1992	L4-1.8L	GP-28	GP-28 SNG	GAVW-120	GG-251	
1991-1990	L4-1.8L	GP-28	GP-28 SNG	GAVW-10	GG-298	

JETTA CITY

2009-2008	L4-2.0L	GP-28	GP-28 SNG	GAVW-621	GG-102	
-----------	---------	-------	-----------	----------	--------	--

LUPO

2009-2005	L4-1.6L	GP-428		GAVW-623	GG-252	GAC-60
-----------	---------	--------	--	----------	--------	--------

NUEVO GOL





2016-2014	L4-1.6L	GP-428		GAVW-628	GG-291	
-----------	---------	--------	--	----------	--------	--

PASSAT

2018	L5-2.5L			GAVW-625		GAC-28
2018	V6-3.6L			GAVW-618		GAC-28
2017-2016	L5-2.5L	G-313		GAVW-625	GG-107	GAC-28
2017	V6-3.6L			GAVW-625		GAC-28
2016-2012	V6-3.6L			GAVW-618		GAC-28
2015-2012	L4-2.0L Turbo diésel	G-362 ⁽¹⁾		GAVW-619		
2015	L5-2.5L	G-313		GAVW-625		GAC-28
2014	L5-2.5L	G-313		GAVW-625	GG-107	GAC-28
2013-2012	L5-2.5L	G-313		GAVW-625		GAC-28
2010	L4-2.0L Turbo	GP-407		GAVW-619		GAC-28
2009-2006	V6-3.6L	G-466		GAVW-618		GAC-28
2009	L4-2.0L Turbo	GP-407, G-313		GAVW-617, GAVW-619		GAC-28
2008	L4-2.0L Turbo	GP-407		GAVW-617		GAC-28
2007-2006	L4-2.0L Turbo	G-313		GAVW-617		GAC-28
2005-2004	L4-1.8L Turbo	GP-28	GP-28 SNG	GAVW-622	GG-251	GAC-10 ⁽⁶⁾ , GAC-8

(1) Nuevo, (6) Con carbón activado

Los filtros Gonher prolongan la vida útil del motor evitando el desgaste prematuro.
Para vehículos anteriores a 1990, consulte nuestro catálogo web en www.grupogonher.com

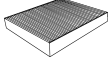
GONHER		ACEITE	SINTÉTICO	AIRE	COMB.	CABINA
AÑO	MOTOR					

VOLKSWAGEN (Continúa)

PASSAT (Continúa)

2005 - 2004	L4-2.0L Turbo diésel	G-8530 ⁽¹⁾				
2005	V6-2.8L	GP-171		GAVW-622	GG-251	
2004 - 2003	V6-2.8L	GP-171		GAVW-622	GG-408	
2004 - 2003	W8-4.0L	G-112		GAVW-622	GG-408	
2003 - 2001	L4-1.8L Turbo	GP-3569		GAVW-622	GG-251	GAC-10 ⁽⁶⁾ , GAC-8
2002 - 1999	V6-2.8L	G-112		GAVW-622	GG-251	
2000 - 1999	L4-1.8L Turbo	GP-3569		GAVW-622	GG-251	
1997	L4-1.9L Turbo diésel	G-8530 ⁽¹⁾				
1997	V6-2.8L	G-112		GAVW-120	GG-251	
1996	V6-2.8L	G-112		GAVW-121	GG-251	
1993 - 1991	L4-2.0L	GP-28	GP-28 SNG	GAVW-120	GG-226	

PASSAT CC

2012 - 2011	V6-3.6L					GAC-28
2012	L4-2.0L Turbo	G-466		GAVW-619		
2011	L4-2.0L Turbo			GAVW-619		
2010	L4-2.0L Turbo	GP-407		GAVW-619		GAC-28
2010	V6-3.6L	G-466		GAVW-618		GAC-28

POINTER

2009 - 1999	L4-1.8L	GP-28	GP-28 SNG	GAVW-620	GG-252	
2003 - 2000	L4-2.0L	GP-28	GP-28 SNG	GAVW-620	GG-252	
1998	L4-1.8L	GP-28	GP-28 SNG	GAVW-620	GG-251	

POINTER TRUCK

2010 - 1999	L4-1.8L	GP-28	GP-28 SNG	GAVW-620	GG-252	
1998	L4-1.8L	GP-28	GP-28 SNG	GAVW-620		

POLO

2020 - 2018	L4-1.6L	GP-561		GAVW-630		GAC-60
2017 - 2016	L4-1.2L Turbo	GP-561				
2017 - 2015	L4-1.6L	GP-561		GAVW-630	GG-107	GAC-60
2017	L4-1.8L Turbo	G-784		GAVW-630	GG-1243	GAC-60
2014 - 2013	L4-1.2L Turbo	GP-561		GAVW-690		
2014 - 2013	L4-1.4L Turbo	GP-561				
2007 - 2003	L4-1.6L	GP-428		GAVW-623	GG-107	GAC-60
2007 - 2003	L4-2.0L	GP-28	GP-28 SNG	GAVW-624	GG-107	GAC-60

ROUTAN

2012 - 2011	V6-3.6L	G-3744		GA-247		
2010 - 2009	V6-3.8L	GP-58	GP-58 SNG	GA-248		
2009	V6-4.0L	GP-406	GP-406 SNG	GA-248		

SAVEIRO

2020 - 2017	L4-1.6L	GP-428		GAVW-628	GG-291	
2016 - 2010	L4-1.6L	GP-428		GAVW-628	GG-291	GAC-60

SEDAN

2004 - 1993	H4-1.6L	GP-28	GP-28 SNG	GAVW-2	GG-251	
1992 - 1990	H4-1.6L	GP-28	GP-28 SNG	GAVW-2	GG-4	

SHARAN





2008 - 2002	L4-1.8L Turbo	GP-28	GP-28 SNG	GAVW-1197 ⁽¹⁾	GG-251	
-------------	---------------	-------	-----------	--------------------------	--------	--

SPORTVAN

2010 - 2007	L4-1.6L	GP-428		GAVW-623	GG-107	
-------------	---------	--------	--	----------	--------	--

(1) Nuevo, (6) Con carbón activado

Los filtros Gonher prolongan la vida útil del motor evitando el desgaste prematuro.
Para vehículos anteriores a 1990, consulte nuestro catálogo web en www.grupogonher.com

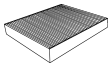
GONHER.		ACEITE 	SINTÉTICO 	AIRE 	COMB. 	CABINA 
AÑO	MOTOR					

VOLKSWAGEN (Continúa)

T-CROSS

2020	L4-1.6L	GP-58	GP-58 SNG	GAVW-2941		GAC-60
------	---------	-------	-----------	-----------	--	--------

TIGUAN

2020 - 2018	L4-2.0L Turbo	G-784				GAC-60
2020	L4-1.4L Turbo	GP-561				
2019 - 2018	L4-1.4L Turbo	GP-561		GAVW-618		GAC-60
2017 - 2014	L4-1.4L Turbo	GP-561		GAVW-618		GAC-28
2017 - 2009	L4-2.0L Turbo	GP-407		GAVW-619		GAC-28
2013	L4-1.4L Turbo	GP-561		GAVW-618		

TOUAREG

2017 - 2016	V6-3.0L Híbrido			GAVW-616		
2017 - 2016	V6-3.6L			GAVW-616		
2017 - 2009	V6-3.0L Turbo diésel			GAVW-616		
2015	V6-3.6L	G-112		GAVW-616		
2014 - 2013	V6-3.0L Híbrido			GAVW-616		
2014 - 2012	V6-3.6L			GAVW-616		
2011	V6-3.6L	G-112, G-2310		GAVW-616		
2009-2008	V6-3.6L	G-112		GAVW-616		
2009-2004	V8-4.2L	G-112		GAVW-616		
2007-2004	V6-3.2L	G-112		GAVW-616		
2007	V10 4.9L Turbo diésel			GAVW-616		

TRANSPORTER

2020	L4-2.0L Diésel	G-466		GAVW-627		
2019	L4-2.0L Turbo diésel	G-466		GAVW-627		
2018	L4-2.0L Turbo diésel	G-362 ⁽¹⁾ , G-466		GAVW-627		
2017 - 2011	L4-2.0L Turbo diésel	G-362 ⁽¹⁾ , G-466		GAVW-627	GP-857	
2010	L4-2.0L Turbo diésel	G-362 ⁽¹⁾ , G-466		GAVW-627		

UP!

2018 - 2016	L3-1.0L	GP-503		GA-2219 ⁽¹⁾		
-------------	---------	--------	--	------------------------	--	--

VAN

2009	L4-1.8L	GP-28	GP-28 SNG			
2008-2007	L4-1.8L	GP-28	GP-28 SNG		GG-106	
2006-2003	L4-1.8L	GP-28	GP-28 SNG	GAVW-212	GG-106	

VENTO

2020 - 2014	L4-1.6L	GP-561		GAVW-630	GG-107	GAC-60
2018	L4-1.5L Turbo diésel	G-362 ⁽¹⁾		GAVW-690		
2016	L4-1.5L Turbo diésel	G-362 ⁽¹⁾		GAVW-690		
2015 - 2014	L4-1.6L Turbo diésel	G-362 ⁽¹⁾		GAVW-690		

VIRTUS





2020	L4-1.6L	GP-58	GP-58 SNG	GAVW-2941 ⁽¹⁾		GAC-2335
------	---------	-------	-----------	--------------------------	--	----------

VOLVO

C30

2013 - 2008	L5-2.5L Turbo	G-570		GA-2216		GAC-2295 ⁽¹⁾
2011 - 2008	L5-2.4L	G-570		GA-2216		GAC-2295 ⁽¹⁾

(1) Nuevo

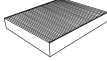
GONHER		ACEITE	SINTÉTICO	AIRE	COMB.	CABINA
AÑO	MOTOR					

VOLVO (Continúa)

C70

2013 - 2006	L5-2.5L Turbo			GA-2216		
2013 - 2006	L5-2.5L Turbo	G-570		GA-2216		GAC-2295 ⁽¹⁾
2001	L5-2.3L Turbo			GA-305		
1999	L5-2.3L Turbo	GP-7328				

S40

2011 - 2004	L5-2.5L Turbo			GA-2216		
2011 - 2004	L5-2.5L Turbo	G-570		GA-2216		
2010 - 2007	L5-2.4L	G-570		GA-2216		GAC-2295 ⁽¹⁾
2010 - 2004	L5-2.4L			GA-2216		GAC-2295 ⁽¹⁾
2004	L4-1.9L Turbo	G-72		GA-283		
2003 - 1999	L4-1.9L Turbo			GA-283		

S60

2016 - 2012	L5-2.5L Turbo			GA-2216		
2008 - 2006	L5-2.4L Turbo	G-72		GA-305		
2007 - 2004	L5-2.5L Turbo	G-72		GA-305		
2005	L5-2.3L Turbo			GA-305		
2004 - 2001	L5-2.3L Turbo	G-72		GA-305		
2003 - 2001	L5-2.4L Turbo	G-72		GA-305		

S60 CROSS COUNTRY

2016	L5-2.5L Turbo	G-570				
------	---------------	-------	--	--	--	--

S70

2000	L5-2.3L Turbo	G-72				
2000	L5-2.4L Turbo	G-72				
1999	L5-2.4L Turbo	GP-7328				

S80

2010 - 2007	V8-4.4L	G-72				
2006 - 2005	L5-2.5L Turbo	G-72				
2005 - 2004	L6-2.9L Turbo	G-72				
2003 - 2000	L6-2.9L	G-72				
2002 - 2000	L6-2.8L Turbo	G-72				
1999	L6-2.8L Turbo	GP-7328				

V40

2016	L4-2.0L Turbo	G-72		GA-283		
2004 - 2000	L4-1.9L Turbo	G-72		GA-283		
1999	L4-1.9L Turbo			GA-283		

V40 CROSS COUNTRY

2016	L4-2.0L Turbo			GA-283		
------	---------------	--	--	--------	--	--

V50

2011 - 2005	L5-2.5L Turbo			GA-2216		GAC-2295 ⁽¹⁾
2010 - 2005	L5-2.4L			GA-2216		GAC-2295 ⁽¹⁾
2007 - 2005	L5-2.5L Turbo	G-570		GA-2216		GAC-2295 ⁽¹⁾

V60 CROSS COUNTRY





2016	L5-2.5L Turbo	G-570				
------	---------------	-------	--	--	--	--

V70

2003 - 2001	L5-2.3L Turbo			GA-305		
2003 - 2001	L5-2.4L Turbo			GA-305		
2000	L5-2.3L Turbo	G-72				
2000	L5-2.4L Turbo	G-72				

(1) Nuevo

Los filtros Gonher prolongan la vida útil del motor evitando el desgaste prematuro.
Para vehículos anteriores a 1990, consulte nuestro catálogo web en www.grupogonher.com

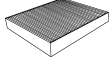
GONHER		ACEITE	SINTÉTICO	AIRE	COMB.	CABINA
AÑO	MOTOR					
VOLVO (Continúa)						
V70 (Continúa)						
1999	L5-2.4L Turbo	GP-7328				
XC60						
2016	L5-2.5L Turbo	G-570				
XC70						
2007-2004	L5-2.5L Turbo	G-72		GA-305		
XC90						
2010-2006	V8-4.4L	G-72				
2006-2004	L5-2.5L Turbo	G-72		GA-638		
2005-2004	L6-2.9L Turbo	G-72		GA-638		
2003	L6-2.9L Turbo			GA-638		

AC DELCO	GONHER.	AC DELCO	GONHER.	FRAM	GONHER.	INTERFIL	GONHER.
88878648	GP-409	PF48	GP-406	PH10890	GP-65	OF-10246	G-3751
AC120	G-330	PF50	GP-42	PH11	GP-5	OF-10295	G-917
AC6198E	G-341	PF51	GP-3980	PH11462	GP-409	OF-10358	G-911
PF1051	GP-462	PF52	GP-48	PH16	GP-81	OF-10530	G-210
PF1070F	GP-178	PF53	GP-58	PH2	GP-68	OF-10575	GP-405
PF1093	GP-3569	PF56	GP-28	PH25	GP-20	OF-10890	GP-65
PF11	GP-13	PF59	GP-3675	PH2825	GP-38	OF-10955	G-3744
PF1127	GP-149	PF61	GP-3675	PH2870A	GP-28	OF-11	GP-5
PF1127	GP-6811	PF63	GP-405	PH2951	GP-2951	OF-1109	G-141
PF1127	GP-40	PF867	GP-24	PH30	GP-3	OF-11665	G-349
PF1164	GP-37	PF952	GP-22	PH3387A	GP-46	OF-11T0	GP-461
PF1180	GP-171	PF960	GP-310	PH3429	GP-3429	OF-11Z1	G-341
PF1218	GP-205	PF973	GP-46	PH3506	GP-44	OF-11Z5	G-241
PF1219	GP-157	PFL400A	GP-3600	PH3508	GP-310	OF-1230	GP-6355
PF1220	GP-156			PH3535	GP-48	OF-13	GP-13
PF1224	GP-3985	FRAM	GONHER.	PH3569	GP-3569	OF-16	GP-81
PF1232	GP-3682	CH10066	G-341	PH3600	GP-3600	OF-2	GP-68
PF1232	GP-38	CH10246	G-3751	PH3614	GP-503	OF-200	G-25
PF1233	GP-2951	CH10295	G-917	PH3614	GP-58	OF-2092	G-5208
PF1237	GP-91	CH10358	G-911	PH3675	GP-3675	OF-25	GP-20
PF1250	GP-68	CH10530	G-210	PH3682	GP-3682	OF-2500	GP-149
PF13	GP-81	CH10759	G-362	PH3786	GP-562	OF-2518	GP-409
PF13	GP-9	CH10955	G-3744	PH3950	GP-40	OF-2815	GP-310
PF141	G-200	CH11665	G-349	PH3976A	GP-178	OF-2825	GP-38
PF1703	G-70	CH11784	G-784	PH3980	GP-3980	OF-2870	GP-28
PF1704	G-3752	CH200PL	G-200	PH3985	GP-3985	OF-2951	GP-2951
PF1707	G-8530	CH330	G-330	PH43	GP-9	OF-2Q67	GP-6714
PF1708	G-466	CH5320	G-963	PH4386	GP-156	OF-30	GP-3
PF1768	G-911	CH6	G-6	PH4558	GP-24	OF-3387	GP-46
PF2	GP-1	CH6848	G-971	PH4701	GP-46	OF-3506	GP-44
PF210	G-6	CH8081	G-954	PH4967	GP-157	OF-3535	GP-48
PF2107	GP-6357	CH8087	G-975	PH5	GP-205	OF-3593	GP-149
PF2111	GP-452	CH8158	G-112	PH5	GP-13	OF-3593H	GP-6811
PF2129	G-765	CH8213	G-984	PH5443	GP-432	OF-3600	GP-3600
PF2139	G-963	CH8481	G-180	PH5548	GP-428	OF-3614	GP-58
PF2140	GP-7328	CH8530	G-8530	PH5618	GP-457	OF-3675	GP-3675
PF2146	G-971	CH8712	G-72	PH5796	GP-291	OF-3682	GP-3682
PF2147	GP-6355	CH8765	G-765	PH5882	GP-453	OF-3950	GP-40
PF2193	G-112	CH8806	G-45	PH6355	GP-6355	OF-3976	GP-178
PF2221	GP-128	CH8905	G-25	PH6357	GP-6357	OF-3980	GP-3980
PF2227E	G-45	CH9018	G-49	PH6607	GP-91	OF-3C11	G-562
PF2232	GP-9100	CH9301	G-910	PH6813	GP-452	OF-3L62	G-362
PF2247G	G-180	CH9301	G-918	PH7317	GP-149	OF-4177	GP-291
PF2248G	G-954	CH9443	G-141	PH7328	GP-7328	OF-4240	GP-112
PF2249G	G-984	CH9461	G-466	PH8316	GP-128	OF-43	GP-9
PF2250G	G-72	CH9549	G-3752	PH8830	GP-455	OF-4386	GP-156
PF2252G	G-975	CH9584	G-446	PH8873	GP-408	OF-4558	GP-24
PF2254	GP-457	CH9641	G-70	PH8994	GP-171	OF-4967	GP-157
PF2257	G-313	CH9706	G-562	PH8A	GP-1	OF-5	GP-205
PF2257	G-570	CH9713	G-713	PH9100	GP-9100	OF-5403	GP-407
PF2257G	G-3751	CH9911	G-313	PH927PL	GP-22	OF-5548D	GP-428
PF2259	G-912	CH9954	G-570	PH966B	GP-37	OF-5562	G-313
PF24	GP-20	CH9972	G-912	PH9688	GP-6811	OF-5618	GP-457
PF24	GP-5	PH10060	GP-406	PH9897	GP-461	OF-6103	GP-561
PF25	GP-3	PH10127	GP-112	PH9897	GP-462	OF-6607	GP-91
PF44	GP-44	PH10267	GP-109			OF-6848	G-971
PF45	GP-3429	PH10575	GP-405	INTERFIL	GONHER.	OF-7300	G-713
PF456G	G-49	PH10600	GP-407	OF-6115	G-784	OF-7503	GP-503
PF46	GP-44	PH10757	GP-561	OF-10060	GP-406	OF-8	GP-1

INTERFIL	GONHER	MANN	GONHER	MOTORCRAFT	GONHER
OF-8081	G-954	M1008	GP-149	AFL36	GP-3985
OF-8087	G-975	ML1001	GP-81	CFL182	GP-310
OF-8158	G-112	ML1001	GP-9	CFL814	GP-44
OF-8213	G-984	ML1003	GP-2951	EFL091	GP-462
OF-8316	GP-128	ML1004	GP-1	EFL150	GP-455
OF-8481	G-180	ML1005	GP-3600	EFL196	G-330
OF-8530	G-8530	ML1006	GP-68	EFL404	G-70
OF-8712	G-72	ML1007	GP-3980	EFL486	G-963
OF-8765	G-765	ML1007	GP-48	EFL909	G-341
OF-8776	G-910	ML1009	GP-157	FL 805	GP-6355
OF-8806	G-45	ML1011	GP-205	FL10	GP-3
OF-8980	G-3753	ML1012	GP-37	FL12	GP-13
OF-8994	GP-171	ML1012	GP-3682	FL181	GP-310
OF-9011	GP-109	ML1013	GP-3675	FL1998	GP-149
OF-9018	G-49	ML1013	GP-44	FL1A	GP-1
OF-9100	GP-9100	ML1014	GP-91	FL2	GP-5
OF-927	GP-22	ML1017	GP-156	FL20	G-6
OF-9301	G-918	ML1019	G-70	FL2005	GP-128
OF-9461	G-466	ML1022	GP-128	FL2008	GP-457
OF-9549	G-3752	ML1023	GP-178	FL2016	G-3752
OF-9584	G-446	ML1025	GP-40	FL2033	GP-205
OF-9641	G-70	ML1028	G-45	FL-2051	GP-65
OF-966	GP-37	ML1030	GP-406	FL2056	GP-406
OF-9954	G-570	ML1031	G-912	FL22	G-200
OF-9972	G-912	ML1033	G-180	FL228	GP-81
		ML1034	G-3752	FL295	GP-24
MANN	GONHER	ML1035	GP-9100	FL315	GP-42
H1032	G-6	ML2000	GP-28	FL331	GP-3429
H9263X	G-963	W 719/30	GP-3569	FL331	GP-3675
H936-1X	G-200	W 735/1	GP-452	FL400A	GP-3600
HU 6002 Z	G-784	W6021	GP-409	FL401	GP-28
HU 711/51X	G-341	W610/82	GP-6811	FL402	GP-48
HU6006z	G-911	W712/21	GP-58	FL404	GP-40
HU6009z	G-3744	W712/52	GP-428	FL-500S	GP-405
HU610X	G-910	W712/53	GP-428	FL504	GP-22
HU612/2X	G-3751	W712/94	GP-561	FL775	GP-46
HU612X	G-141	W712/95	GP-503	FL793	GP-58
HU69/2X	G-49	W713/16	GP-24	FL799	GP-6811
HU7008z	G-362	W716/81	GP-461	FL800	GP-38
HU711/2	G-70	W719/45	GP-407	FL801	GP-37
HU712/6X	G-562	W719/5	GP-28	FL801	GP-3682
HU713/1X	G-713	W719/7	GP-457	FL810	GP-91
HU715/15X	G-210	W75/3	GP-291	FL815	GP-91
HU715/4X	G-975	W75/5	GP-46	FL820	GP-68
HU716/2X	G-241	W8027	GP-6714	FL836	GP-157
HU718/1K	G-918	W818/82	GP-38	FL839	GP-3682
HU718/5X	G-180	W9009	GP-109	FL840	GP-2951
HU719/6X	G-313	W9066	GP-6355	FL896	GP-178
HU719/7X	G-466	W914/2	GP-22	FL9	GP-20
HU719/8X	G-570	W914-80	GP-42	FT74	GP-171
HU726/2X	G-8530	W920/48	GP-171	MFL 2014	GP-58
HU727/1 X	G-971	W930/26	GP-112	MFL2042	GP-291
HU816/2 X	G-446	W935	GP-13	MFL402	GP-3980
HU819/1X	G-25	W936/2	GP-20	MFL6714BOR	G-313
HU819X	G-72	W936/2	GP-5	MFL6714MAL	G-49
HU825X	G-5208	W936/5	GP-3	MFL6714TOYC	GP-156
HU925/4X	G-954	W950/4	GP-310		
HU932/6N	G-112	WP914/80	GP-6357		
HU938/4X	G-984				

AC DELCO	GONHER	AC DELCO	GONHER	AC DELCO	GONHER	AC DELCO	GONHER
A279C	GA-55	A1290C	GAVW-121	A2014C	GA-414R	A3114C	GA-492
19381690	GA-330	A1291C	GA-394	A2014C	GA-344	A3115C	GA-489
93428149	GA-134	A1291C	GAVW-620	A2036C	GA-263	A3118C	GA-464
A1034C	GA-49	A1292C	GA-175	A2038C	GA-479	A3119C	GA-771
A1052C	GA-4325	A1298C	GA-132	A2039C	GA-224	A3131C	GA-1572
A1089C	GA-277	A1300C	GA-673R	A2040C	GA-168	A3134C	GA-380
A1092C	GA-165	A1301C	GA-732R	A2044C	GA-607	A3137C	GA-167
A1096C	GA-6479	A1309C	GA-7167	A2046C	GAVW-621	A3138C	GA-3138
A1097C	GA-7007	A130C	GA-105	A2047C	GA-286	A3144C	GA-294
A1098C	GA-153	A1311C	GA-432	A2048C	GA-278R	A3145C	GA-350
A1103C	GA-70	A1313C	GAD-129	A2051C	GA-183	A3169C	GAVW-651
A1106C	GA-89	A1316C	GA-7626	A2052C	GA-491	A3174C	GA-1251
A1109C	GA-180	A1323C	GAD-118	A2053C	GA-780	A3184C	GA-355
A1111C	GA-6626	A1329C	GA-198	A2054C	GA-183R	A3198C	GAD-116
A1112C	GA-147	A132C	GA-50	A2055C	GA-248	A3202C	GA-6313
A1113C	GA-3814	A1330C	GA-231	A2056C	GA-8121	A323CM	GA-323
A1115C	GA-5056	A1340C	GA-7617	A2057C	GA-472	A329C	GA-57
A1131C	GA-273	A1341C	GA-240	A2058C	GA-780	A329C	GA-327
A1132C	GAD-30	A1347C	GA-5466	A218	GA-78	A348C	GA-59
A1138C	GA-166	A134C	GA-71	A235C	GA-11	A354C	GA-730
A1143C	GA-129	A1351C	GA-2156	A2611C	GA-2130	A355C	GA-85
A1144C	GA-4383	A1358C	GA-2184	A283C	GA-230	A357C	GA-303
A1146C	GA-174	A1411C	GAVW-622	A2847C	GAVW-626	A365C	GA-12
A1148C	GA-216	A1413C	GA-605	A2848C	GA-304	A3672C	GA-2217
A1149C	GA-2106	A1414C	GA-2114	A2930C	GA-9948	A391C	GAD-1
A114C	GA-90	A1415C	GA-2195	A2933C	GA-264	A392C	GA-6620
A1160C	GA-2110	A1416C	GA-128	A2934C	GA-194	A4068C	GA-328
A1164C	GA-195	A1417C	GA-127	A2935C	GA-293	A467C	GA-75
A1166C	GA-3901	A142C	GA-44	A2938C	GA-364	A479C	GA-429
A1170C	GA-3588	A1430C	GAK-16	A2940C	GA-488	A494C	GA-74
A1172C	GA-3916	A1500C	GA-6	A2941C	GA-477	A592C	GA-3300
A117C	GA-184	A1506C	GA-7	A2943C	GA-490	A644C	GA-3492
A117C	GA-77	A1507C	GA-145	A2945C	GA-1545	A735C	GA-54
A1193C	GA-195	A1509C	GA-1616	A2949C	GA-448	A736C	GA-3523
A1195C	GA-275	A1511C	GA-384	A2950C	GA-138	A737C	GAVW-2
A1201C	GA-362	A1512C	GA-172	A2951C	GA-269	A742C	GA-3425
A1203C	GA-142	A1513C	GA-244	A2952C	GA-443	A743C	GA-3424
A1208C	GA-164	A1514C	GA-2198	A2955C	GA-1617	A748C	GA-2719B
A1212C	GA-139	A1514C	GA-438	A2956C	GA-9969	A752C	GAVW-4
A1221C	GA-276	A1517C	GA-1615	A2957C	GA-395	A755C	GAVW-22
A1226C	GAVW-120	A1517C	GA-8039	A2964C	GA-385	A785C	GA-3647
A1229C	GA-5125	A1519C	GA-348	A2965C	GA-2146	A7975C	GA-258
A1231C	GA-6619	A152C	GA-80	A2987C	GA-2124	A826C	GA-3681
A1232C	GA-6690	A1546C	GA-1614	A2991C	GA-4999	A831C	GA-734
A1246C	GAD-294	A1547C	GA-130	A2997C	GA-9392	A858C	GA-271
A1251C	GA-386	A1548C	GA-301	A3000C	GA-2175	A917C	GA-392
A1252C	GA-2141	A1549C	GA-595	A3015C	GA-2193	A925C	GA-253
A1255C	GA-133	A1558C	GA-2118	A3054C	GA-298	A929C	GA-274
A1257C	GAD-117	A1604C	GA-158	A3081C	GA-324	A948C	GA-219
A1257C	GAD-17	A1608C	GAD-3	A3083C	GA-3083	A975C	GAD-15
A1267C	GA-300	A1610C	GA-8606	A3088C	GA-1548	ACA131	GA-137
A1279C	GA-279	A1611C	GA-163	A3089C	GA-289	AE1287CM	GA-314
A1282C	GA-7142	A1612C	GA-170	A3090C	GA-646	AF20041	GA-2104
A1283C	GA-7344	A1614C	GA-8754	A3095C	GA-266	FB102	GA-101
A1284C	GA-217	A1621C	GA-413R	A3096C	GA-2234	FB106	GA-176
A1285C	GA-141	A1623C	GAVW-212	A3103C	GA-265	FB111	GA-186
A1286C	GA-322	A1624C	GA-415	A3104C	GA-320	FB59	GA-100
A1287C	GA-381	A1627C	GA-367	A3109C	GA-546	FB60	GA-113
A1289C	GA-514	A178CW	GA-192	A3110C	GA-383	PC 2054 E	GA-410

AC DELCO	GONHER.	FRAM	GONHER.	FRAM	GONHER.	FRAM	GONHER.
PC 2060 E	GA-2160	CA10414	GA-2220R	CA11877	GA-2378	CA3559	GA-271
PC3324E	GA-1444	CA10418	GA-2217	CA11942	GA-2221	CA3588	GA-3588
FRAM	GONHER.	CA10464	GA-232	CA11943	GA-8113	CA3597	GA-734
BA-24	GA-113	CA10465	GA-3138	CA11945	GA-5200	CA3642	GA-101
BA7756	GA-186	CA10466	GA-266	CA11948	GA-2233	CA3647	GA-3647
CA10013	GA-383	CA10467	GA-193	CA11949	GA-345	CA3660	GA-277
CA10014	GA-246	CA10468	GA-171	CA11950	GA-2226R	CA3681	GA-3681
CA10024	GA-2144	CA10488	GA-1570	CA11952	GA-1500	CA3684	GA-219
CA10064	GA-242	CA10497	GA-609	CA12050	GA-1720	CA3717	GA-274
CA10071	GA-1571	CA10509	GAVW-630	CA12051	GA-5022	CA3784	GA-231
CA10081	GA-114	CA10522	GA-2232	CA12055	GA-1781	CA381	GA-74
CA10085	GAVW-625	CA10564	GA-110	CA12057	GA-2218	CA381	GA-381
CA10086	GA-308	CA10616	GA-222R	CA12065	GA-1033	CA3814	GA-3814
CA10088	GA-363	CA10626	GA-2234	CA12073	GA-310	CA3901	GA-3901
CA10091	GAVW-1197	CA10630	GA-366	CA12088	GA-9530	CA3902	GA-253
CA10092	GA-1544	CA10633	GA-331	CA12104	GAVW-2941	CA3914	GA-392
CA10093	GA-298	CA10650	GA-347	CA12112	GA-6313	CA3916	GA-3916
CA10094	GA-1572	CA10651	GA-859	CA12296	GA-1618	CA3924	GA-153
CA10096	GA-5627	CA10677	GA-317	CA12315	GAD-6554	CA3997	GA-216
CA101	GA-105	CA10690	GA-167	CA12413	GA-9079	CA4010	GA-272
CA10110	GA-3083	CA10694	GA-4444	CA12520	GA-1619	CA4309	GAD-15
CA10115	GA-290	CA10696	GAVW-1262	CA133	GA-78	CA4325	GA-4325
CA10118	GA-489	CA10739	GA-346	CA136	GA-55	CA4354	GA-230
CA10162	GA-1804	CA10755	GA-478	CA146	GA-71	CA4383	GA-4383
CA10163	GA-1780	CA10781	GA-1541	CA148	GA-80	CA4576	GA-2110
CA10165	GA-340	CA10885	GA-321	CA160	GA-70	CA4778	GA-147
CA10169	GA-320	CA10888	GA-439	CA184	GA-77	CA4830	GA-180
CA10171	GA-464	CA10889	GA-889	CA187	GA-90	CA4924	GAD-117
CA10173	GA-1540	CA10910	GA-8274	CA189	GA-50	CA4939	GA-139
CA10190	GA-265	CA10989	GA-294	CA19	GA-100	CA5029	GA-8
CA10191	GA-149	CA10990	GA-350	CA192	GA-192	CA5056	GA-5056
CA10192	GA-492	CA10997	GA-430	CA2096	GA-6619	CA5058	GA-273
CA10193	GA-328	CA11001	GA-150	CA2662	GAVW-22	CA5111	GA-2156
CA10228	GA-143	CA11003	GA-1545	CA2663	GA-218	CA5125	GA-5125
CA10233	GA-182	CA11042	GA-223	CA2676	GAD-3	CA5229	GA-2121
CA10234	GAD-116	CA11048	GA-220R	CA2719	GA-2719B	CA-5329	GA-2160
CA10236	GAVW-616	CA11050	GA-247	CA303	GA-303	CA5345	GA-410
CA10241	GAD-46R	CA11071	GA-330	CA305	GA-730	CA5350	GA-2114
CA10242	GA-1542	CA11072	GA-1444	CA3105	GA-49	CA5370	GAVW-121
CA10253	GA-2216	CA11077	GA-6262R	CA324	GA-85	CA5377	GAVW-212
CA10254	GA-1546	CA11104	GA-2215	CA3245	GAD-30	CA5466	GA-5466
CA10256	GAVW-617	CA11109	GA-3648	CA326	GA-59	CA-5488	GA-2173
CA10261	GA-252	CA11113	GA-1113	CA327	GA-57	CA5496	GA-134
CA10262	GA-437	CA11114	GA-226R	CA327	GA-327	CA5513	GAVW-620
CA10270	GA-550	CA11171	GA-246	CA3300	GA-3300	CA-5538	GA-2118
CA10286	GA-243	CA11206	GA-365	CA3359	GA-234	CA-5539	GA-2195
CA10290	GA-27161	CA11215	GA-306	CA3373	GAVW-2	CA5595	GA-595
CA10293	GA-1596	CA11222	GA-344	CA3399	GAVW-4	CA-5657	GA-2174
CA10293	GA-2229	CA11251	GA-1251	CA3424	GA-3424	CA5682	GA-179
CA10324	GA-2231	CA11258	GA-722	CA3425	GA-3425	CA-5782	GA-2175
CA10328	GAVW-618	CA11259	GA-924	CA3441M	GAVW-10	CA5876	GA-5876
CA10330	GAVW-651	CA11431	GA-7127	CA347	GA-429	CA-5891	GA-2146
CA10343	GA-393	CA11450	GA-1531	CA3492	GA-3492	CA6362	GA-362
CA10344	GA-341	CA11456	GA-225	CA3497	GA-75	CA6366	GA-174
CA10346	GA-1529	CA11476	GA-190	CA3501	GA-3501	CA6376	GA-142
CA10348	GA-4018	CA11477	GA-191	CA352	GAD-1	CA6395	GA-195
CA10349	GA-1530	CA11480	GA-1573	CA3523	GA-3523	CA6479	GA-6479
CA10355	GA-603	CA11501	GA-355	CA3537A	GA-54	CA6491	GA-129
		CA11858	GAD-546	CA3549	GA-89	CA6545	GAVW-120

FRAM	GONHER.	FRAM	GONHER.	FRAM	GONHER.	INTERFIL	GONHER.
CA6555	GA-275	CA8142	GA-130	CA9425	GA-2104	F-101A10	GA-3083
CA6558	GA-2106	CA8169	GAVW-626	CA9471	GA-448	F-101A15	GA-290
CA6576	GA-276	CA-8194	GA-2141	CA9481	GA-387	F-101A25	GA-1500
CA6591	GA-176	CA8205	GA-301	CA9482	GA-263	F-101A62	GA-1804
CA6619	GA-6620	CA8208	GA-607	CA9487	GA-137	F-101A63	GA-1780
CA6626	GA-6626	CA8220	GA-2105	CA9492	GA-367	F-101A73	GA-1540
CA6664	GA-166	CA8221	GA-279	CA9493	GA-184	F-101A90	GA-265
CA6690	GA-6690	CA8225	GA-145	CA9511	GA-284	F-102A23	GA-191
CA6807	GA-386	CA8269	GA-472	CA9516	GA-4999	F-102A42	GA-1542
CA6828	GA-133	CA8475	GA-170	CA9519	GAVW-623	F-102A54	GA-1546
CA6849	GAD-129	CA8548	GA-304	CA9544	GA-2109	F-102A61	GA-252
CA6850	GAD-294	CA8602	GAVW-621	CA9563	GA-158	F-102A70	GA-550
CA6900	GAD-17	CA8606	GA-8606	CA9564	GA-138	F-102A86	GA-243
CA6931	GAD-29	CA-8674	GA-2159	CA9589	GA-488	F-102A93	GA-1596
CA7007	GA-7007	CA8720	GA-2130	CA9590	GA-289	F-102A96	GA-2233
CA7142	GA-7142	CA8736	GA-280	CA9600	GA-269	F-103A24	GA-2231
CA7167	GA-7167	CA8747	GA-258	CA9601	GA-281	F-103A28	GAVW-618
CA73	GA-44	CA8754	GA-8754	CA9609	GA-196	F-103A30	GAVW-651
CA7337	GA-2184	CA8756	GA-348	CA9610	GA-291	F-103A43	GA-393
CA7344	GA-7344	CA8760	GA-183	CA9634	GA-241	F-103A44	GA-341
CA7351	GA-322	CA8766	GA-491	CA9636	GA-638	F-103A48	GA-4018
CA7365	GA-217	CA8768	GA-2198	CA9646	GA-646	F-103A49	GA-1530
CA74	GA-11	CA-8789	GA-2181	CA9652	GA-397	F-103A95	GA-9530
CA7414	GA-141	CA8797	GA-314	CA9662	GA-510	F-104A08	GA-1084
CA7417	GA-198	CA8805	GA-278R	CA9669	GA-597	F-104A20	GA-2218
CA7420	GA-514	CA8817	GA-477	CA9681	GA-606	F-104A64	GA-232
CA7421	GA-165	CA8911	GA-194	CA9683	GA-380	F-104A65	GA-3138
CA7426	GA-432	CA8918	GA-286	CA9687	GA-1617	F-104A66	GA-266
CA7432	GA-132	CA8925	GA-780	CA9689	GA-2161	F-104A67	GA-193
CA7438	GA-442	CA8937	GA-2136	CA9711	GAVW-619	F-104A68	GA-171
CA7440	GA-300	CA8956	GA-479	CA9730	GA-285	F-104A97	GA-609
CA7597	GA-164	CA8958	GA-433	CA9762	GA-249	F-106A26	GA-2234
CA76	GA-12	CA8963	GA-2123	CA9778	GA-415	F-106A50	GA-347
CA7605	GA-605	CA-8964	GA-2158	CA9800	GAVW-629	F-106A90	GA-167
CA7614	GA-394	CA8969	GA-168	CA9833	GA-288R	F-107A39	GA-346
CA7617	GA-7617	CA8997	GA-224	CA9875	GA-486	F-107A55	GA-478
CA7620	GA-438	CA9007	GA-2114	CA9888	GAD-34	F-107A81	GA-1541
CA7626	GA-7626	CA9053	GA-183R	CA9894	GA-594	F-108A88	GA-439
CA7628	GAD-118	CA9054	GA-248	CA9895	GA-1548	F-108A89	GA-889
CA7640	GA-240	CA9073	GA-305	CA9898	GA-596	F-10A01	GAD-36
CA7651	GAVW-622	CA9082	GA-215	CA9902	GA-324	F-10A33	GA-1033
CA77	GA-7	CA9098	GA-4319	CA9916	GA-412R	F-10A45	GA-220R
CA7726	GA-6	CA-9102	GA-2135	CA9944	GA-771	F-10AL0	GA-1781
CA7730	GA-175	CA9115	GA-364	CA9948	GA-9948	F-110A01	GA-150
CA7737	GA-128	CA9269	GA-413R	CA9956	GAVW-624	F-110A03	GA-1545
CA7738	GA-127	CA9284	GA-391	CA9957	GA-302	F-110A42	GA-223
CA7764	GA-172	CA9288	GA-283	CA9959	GA-334	F-110A50	GA-247
CA7774	GA-1616	CA9332	GA-395	CA9969	GA-9969	F-111A09	GA-3648
CA8004	GA-8039	CA9345	GA-414R	CA9997	GA-546	F-111A13	GA-1113
CA8007	GA-2193	CA9359	GA-293	CAK253	GAK-16	F-112A51	GA-1251
CA8037	GA-732R	CA9360	GA-264	INTERFIL	GONHER.	F-112A58	GA-722
CA8038	GA-673R	CA9361	GA-385	F-100A13	GA-383	F-114A31	GA-7127
CA8039	GA-1615	CA9367	GA-7147	F-100A14	GA-246	F-114A56	GA-225
CA8040	GA-384	CA9392	GA-9392	F-100A64	GA-242	F-114A76	GA-190
CA8069	GA-244	CA9400	GA-780	F-100A71	GA-1571	F-114A80	GA-1573
CA8080	GAVW-622	CA9401	GA-490	F-100A88	GA-363	F-115A01	GA-355
CA8121	GA-8121	CA9402	GA-443	F-100A94	GA-1572	F-11A10	GA-2109
CA8133	GA-163	CA9409	GA-2124	F-100A96	GA-2378	F-11A20	GA-2164
CA8141	GA-1614	CA9410	GAVW-628			F-11A31	GA-2221

INTERFIL	GONHER	INTERFIL	GONHER	INTERFIL	GONHER	INTERFIL	GONHER
F-11A34	GA-368	F-25A10	GA-281	F-46A00	GA-1529	F-71A42	GA-7142
F-11A43	GA-2184	F-26A62	GAVW-22	F-46A60	GAD-34	F-71A55	GA-2216
F-11A69	GA-320	F-27A10	GA-294	F-48A30	GA-180	F-71A67	GA-7167
F-11A96	GA-1196	F-27A50	GA-302	F-49A04	GA-2232	F-71A74	GA-381
F-12A06	GA-2173	F-28A00	GA-365	F-49A24	GA-924	F-72A86	GA-4319
F-12A13	GA-926	F-28A11	GA-110	F-49A31	GA-317	F-73A44	GA-7344
F-12A50	GA-250	F-28A13	GA-115	F-49A39	GA-139	F-73A51	GA-322
F-12A96	GAVW-630	F-29A56	GA-9969	F-50A08	GA-345	F-73A65	GA-217
F-136A	GA-55	F-29A62	GA-2219	F-50A56	GA-5056	F-74A14	GA-141
F-137A80	GA-327	F-29A01	GAVW-1262	F-50A58	GA-273	F-74A17	GA-198
F-13A06	GA-2123	F-2KA53	GAK-16	F-51A25	GA-5125	F-74A20	GA-514
F-13A27	GA-350	F-2KA62	GAVW-629	F-51A85	GA-2215	F-74A21	GA-165
F-13A36	GA-6313	F-303A	GA-303	F-52A00	GA-5200	F-74A31	GAVW-121
F-13A71	GA-2217	F-305A	GA-730	F-52A02	GA-2226R	F-74A32	GA-132
F-13A78	GA-331	F-30A30	GA-2230	F-52A04	GA-6262R	F-74A38	GA-442
F-146A	GA-71	F-30A54	GA-298	F-53A50	GA-272	F-74A40	GA-300
F-148A	GA-80	F-31A28	GA-366	F-53A50U	GA-2114	F-75A01	GA-410
F-14A06	GA-2159	F-326A	GA-59	F-54A63	GA-1531	F-75A97	GA-164
F-14A44	GA-114	F-327A	GA-57	F-54A65	GAD-6554	F-76A05	GA-605
F-14A85	GA-323	F-32A45	GAD-30	F-54A66	GA-5466	F-76A14	GA-394
F-15A00	GA-603	F-33A00	GA-3300	F-54A96	GA-134	F-76A14	GAVW-620
F-15A01	GA-2229	F-33A59	GA-234	F-55A26	GA-510	F-76A17	GA-7617
F-160A	GA-70	F-33A84	GAVW-2	F-55A95	GA-595	F-76A26	GA-7626
F-16A54	GAD-46R	F-33A95	GA-163	F-56A26	GA-289	F-76A28	GAD-118
F-16A60	GA-2181	F-33A99	GAVW-4	F-57A14	GA-1478	F-76A40	GA-240
F-16A88	GA-168	F-347A	GA-429	F-57A24	GA-291	F-76A51	GAVW-622
F-16A91	GA-492	F-34A24	GA-3424	F-57A24	GA-2158	F-77A30	GA-175
F-16A94	GA-489	F-34A41	GAVW-10	F-580A	GA-179	F-77A37	GA-128
F-16AK0	GA-306	F-34A50	GA-328	F-583A	GA-196	F-77A38	GA-127
F-17A00	GA-321	F-351A	GA-75	F-60A00	GAD-116	F-77A64	GA-172
F-17A01	GA-268	F-352A	GAD-1	F-62A04	GA-226R	F-77A74	GA-1616
F-17A05	GA-1720	F-353A	GAD-3	F-63A62	GA-362	F-78A07	GA-137
F-17A22	GA-340	F-35A37A	GA-54	F-63A66	GA-174	F-7HA01	GAVW-627
F-17A50	GA-780	F-35A59	GA-271	F-63A76	GA-142	F-7KA12	GAVW-625
F-17A71	GA-771	F-35A88	GA-3588	F-63A95	GA-195	F-7LA01	GAVW-616
F-17A80	GA-412R	F-35A96	GA-3596R	F-63AJ0	GA-333	F-7MA31	GAVW-1197
F-17A81	GA-292	F-35A97	GA-734	F-64A79	GA-6479	F-7NA15	GAVW-628
F-17AH0	GA-464	F-36A12	GAVW-623	F-64A91	GA-129	F-8080	GAVW-622
F-184A	GA-77	F-36A47	GA-3647	F-65A45	GAVW-120	F-80A04	GA-1615
F-189A	GA-50	F-36A60	GA-277	F-65A46	GAD-546	F-80A04	GA-8039
F-18A36	GA-183R	F-37A17	GA-274	F-65A55	GA-275	F-80A07	GA-2193
F-18A83	GA-437	F-381A	GA-74	F-65A76	GA-276	F-80A37	GA-732R
F-18A90	GA-1570	F-38A14	GA-3814	F-66A00	GAD-315	F-80A38	GA-673R
F-192A	GA-192	F-39A01	GA-3901	F-66A19	GA-6619	F-80A60	GA-49
F-19A04	GA-430	F-39A02	GA-253	F-66A19A	GA-6620	F-80A69	GA-244
F-19A35	GA-334	F-39A14	GA-392	F-66A64	GA-166	F-80A71	GA-2175
F-1KA01	GAVW-619	F-39A16	GA-3916	F-66A90	GA-6690	F-80A74	GA-2224
F-20A04	GA-391	F-39A24	GA-153	F-68A07	GA-386	F-81A13	GA-8113
F-20A10	GA-182	F-41A00	GAD-117	F-68A14	GA-2141	F-81A21	GA-8121
F-20A51	GA-2051	F-41A16	GAVW-212	F-68A26	GA-6826	F-81A41	GA-1614
F-20A55	GA-2055	F-41A29	GAVW-2941	F-68A49	GAD-129	F-81A42	GA-130
F-20A69	GAVW-690	F-43A09	GAD-15	F-68A50	GAD-294	F-82A05	GA-301
F-21A00	GAD-295	F-43A83	GA-4383	F-69A00	GAD-17	F-82A08	GA-607
F-21A03	GA-364	F-44A94	GA-314	F-69A22	GAVW-692	F-82A20	GA-2105
F-21A41	GA-5627	F-44APT	GA-2144	F-6CA11	GA-27161	F-82A21	GA-279
F-22A05	GA-5022	F-44AQR	GA-4444	F-6EA53	GA-1544	F-82A25	GA-145
F-24A04	GA-490	F-44ATV	GA-1444	F-6FA13	GAVW-617	F-82A59	GA-859
F-24A08	GA-415	F-44AW2	GA-215	F-6QA01	GAVW-624	F-82A74	GA-8274
F-24A61	GA-397	F-45A76	GA-2110	F-70A07	GA-7007	F-82A95	GA-2146

INTERFIL	GONHER.	INTERFIL	GONHER.	MANN	GONHER.	MANN	GONHER.
F-84A75	GA-170	F-96A82	GA-2161	C2256	GA-134	C27002	GA-341
F-85A00	GA-413R	F-96A83	GA-380	C2262	GA-139	C27003/1	GA-609
F-86A02	GAVW-621	F-96A87	GA-1617	C2266	GA-1544	C27009	GAVW-692
F-86A06	GA-8606	F-96A90	GA-344	C2295/2	GAVW-628	C27019	GA-924
F-86A25	GA-2106	F-96A94	GA-2214	C2295/4	GAVW-624	C27107	GA-294
F-86A51	GAVW-626	F-97A62	GA-249	C23041	GA-9530	C27114	GA-232
F-86A71	GA-305	F-98A94	GA-594	C23107	GA-412R	C2714	GA-281
F-87A36	GA-280	F-98A95	GA-1548	C2329	GAD-117	C27154/1	GAVW-121
F-87A47	GA-258	F-98A98	GA-596	C2332	GA-7142	C27161	GA-27161
F-87A54	GA-8754	F-99A02	GA-324	C2339	GAD-3	C27192/1	GA-2124
F-87A55	GA-348	F-99A33	GA-143	C2376	GA-8606	C2731/1	GA-5466
F-87A60	GA-183	F-99A48	GA-9948	C24005	GA-265	C2736/1	GA-7617
F-87A66	GA-491	F-99A97	GA-546	C24010	GA-366	C2742	GA-302
F-87A67	GA-2195	F-9LA84	GA-222R	C24011	GA-603	C2775	GA-363
F-87A68	GA-2198	IBE-1603	GA-186	C24012	GA-355	C28036	GA-2221
F-87A68	GA-438			C24019	GA-333	C28107	GAD-118
F-88A05	GA-278R	MANN	GONHER.	C24021	GA-1113	C28125	GA-248
F-88A17	GA-477	C 2030	GA-2214	C24028	GA-344	C28136/1	GAVW-212
F-89A11	GA-194	C 25 115	GA-859	C24106	GA-2106	C28150	GA-300
F-89A18	GA-286	C 29015	GA-2219	C24137/1	GA-2216	C28214/1	GA-2141
F-89A25	GA-780	C 32 130	GA-2232	C2420	GAD-116	C2860	GA-277
F-89A37	GA-2136	C 9003/1	GA-2215	C2432	GA-242	C2860	GAVW-10
F-89A56	GA-479	C1036/1	GA-2136	C2438	GA-7344	C2861/2	GA-2161
F-89A58	GA-433	C1113	GA-44	C2452	GA-164	C29105	GA-2105
F-89A70	GA-216	C13103	GAD-30	C24567	GA-327	C29108	GA-394
F-89A97	GA-224	C13114/4	GA-49	C2477	GA-4383	C29108	GAVW-620
F-90A07	GA-2114	C1381	GA-2181	C2493	GA-2193	C29132	GA-2231
F-90A54	GA-248	C14130	GAVW-629	C2496	GA-780	C29198/1	GAVW-626
F-90A79	GA-9079	C14177	GA-410	C25016	GA-365	C2938	GA-3425
F-92A88	GA-283	C14179/4	GAK-16	C25040	GAD-546	C2964	GAD-15
F-93A32	GA-395	C14210/2	GA-413R	C25101	GA-215	C2975	GA-477
F-93A45	GA-414R	C15008	GAVW-690	C25114	GA-2114	C2998/5	GAVW-623
F-93A59	GA-293	C16010/1	GA-6262R	C25117/2	GA-215	C30009	GA-464
F-93A60	GA-264	C1618	GAD-315	C2512/2	GA-1529	C30125/1	GA-289
F-93A61	GA-385	C17004	GA-2226R	C25146	GA-2146	C30130	GA-234
F-93A67	GA-7147	C17006	GA-430	C2524	GA-7167	C30130	GA-334
F-93A92	GA-9392	C17237	GA-2220R	C2532	GA-6690	C30170	GA-646
F-94A02	GA-443	C1724	GA-182	C2537/2	GA-386	C30195/2	GA-2195
F-94A09	GA-2124	C18004	GA-347	C2538	GA-292	C30198	GA-143
F-94A71	GA-448	C18149/1	GAD-46R	C2545/1	GA-3588	C3025	GA-303
F-94A81	GA-387	C1858/2	GA-291	C2562	GA-216	C3027/1	GA-514
F-94A82	GA-263	C1858/2	GA-2158	C2564	GA-595	C3028	GA-328
F-94A92	GA-367	C1891	GA-362	C2565	GA-595	C30290	GA-3501
F-94A93	GA-184	C1995	GA-114	C25654	GA-8274	C31116	GAVW-1197
F-95A16	GA-4999	C20010	GA-7127	C2568	GA-5125	C31125	GA-59
F-95A23	GA-310	C20017	GA-310	C2569	GA-5627	C31152/1	GAVW-120
F-95A61	GA-2156	C2055	GA-172	C2585	GA-5627	C3173	GA-2173
F-95A63	GA-158	C21001	GAD-295	C26003	GA-320	C32010	GAVW-1262
F-95A64	GA-138	C21014	GAVW-2941	C26006	GA-137	C32014	GA-393
F-95A89	GA-488	C2119	GA-314	C26027	GA-1500	C32120/3	GA-1530
F-96A00	GA-269	C2159	GA-2159	C26032	GA-115	C32123	GA-2123
F-96A01	GA-284	C22024	GA-3596R	C2610	GA-2230	C32164	GA-2164
F-96A20	GA-285	C22117	GAVW-4	C26106	GA-350	C32191/1	GAVW-627
F-96A21	GA-288R	C2214	GA-323	C26110/1	GA-2110	C3240	GA-2719B
F-96A23	GA-330	C2223	GA-142	C26144	GAVW-622	C3251/1	GA-4319
F-96A36	GA-638	C2234/1	GA-71	C2674/1	GA-110	C3261	GA-128
F-96A46	GA-646	C2240	GA-340	C2681	GA-258	C33017	GA-1781
F-96A69	GA-597	C2244	GA-284	C2683	GA-492	C33103	GA-442
F-96A81	GA-606	C2245	GA-926	C2693	GA-280	C33156	GA-2156

MANN	GONHER	MANN	GONHER	MANN	GONHER	MOTORCRAFT	GONHER
C33189/1	GA-397	MA1038	GA-271	MA1156	GA-240	FA1087	GAD-117
C33194	GA-638	MA1040	GA-1617	MA1157	GA-1571	FA1088	GA-147
C34109	GAVW-2	MA1042	GA-194	MA1158	GA-1615	FA1089	GA-78
C34175	GA-2175	MA1043	GA-7626	MA1158	GA-8039	FA1097	GA-139
C3485	GA-2184	MA1046	GA-130	XC1-1349	GA-290	FA1099	GA-3901
C3498	GA-196	MA1048	GA-168	MOTORCRAFT	GONHER	FA11	GA-105
C35009	GA-1196	MA1049	GA-198	1131649	GA-179	FA1100	GA-362
C35154	GAVW-619	MA1050	GA-132	1216907	GA-196	FA1101	GA-195
C3585	GA-1444	MA1051	GA-175	A45381	GA-732R	FA1107	GA-5125
C3594/1	GA-3901	MA1052	GA-184	AFA8	GA-71	FA1108	GA-6619
C36002	GA-4444	MA1053	GA-138	AFA85	GA-85	FA1109	GA-6626
C36003	GA-4444	MA1054	GA-286	CFA1081	GAD-30	FA1112	GA-6690
C36013	GA-330	MA1056	GAD-294	CFA2002	GA-253	FA1121	GAD-118
C36020	GA-368	MA1058	GA-183R	CFA2004	GA-153	FA1127	GA-6479
C36188	GAVW-618	MA1059	GA-278R	E5D323603	GA-4383	FA123	GA-11
C36930	GA-264	MA1060	GA-392	EFA 553	GA-2160	FA1345	GA-216
C3698/2	GA-2198	MA1064	GA-195	EFA107	GAD-3	FA1348	GA-392
C3698/2	GA-438	MA1065	GA-9392	EFA153	GA-218	FA1351	GA-2106
C37132	GA-285	MA1067	GA-3814	EFA158	GA-230	FA1352	GA-129
C37153/1	GAVW-621	MA1068	GA-253	EFA160	GAVW-2	FA1360	GA-276
C3725	GA-293	MA1070	GA-367	EFA243	GAVW-4	FA1603	GA-186
C3880	GAVW-630	MA1071	GA-488	EFA261	GA-277	FA161	GAD-1
C39219	GAVW-616	MA1072	GA-479	EFA269	GA-49	FA1611	GA-175
C40107	GA-127	MA1073	GA-607	EFA302	GAK-16	FA1612	GA-127
C41110	GAVW-617	MA1074	GA-491	EFA445	GA-2110	FA1613	GA-128
C4151	GA-179	MA1076	GA-170	EFA493	GA-2156	FA1614	GA-300
C43102	GAVW-625	MA1077	GA-141	EFA501	GAVW-120	FA1615	GA-1615
C4312	GAVW-651	MA1078	GA-385	EFA523	GAVW-622	FA1615	GA-8039
C4371	GA-2144	MA1079	GA-275	EFA535	GAD-15	FA1616	GA-1616
C47109	GA-2109	MA1080	GA-244	EFA562	GAVW-121	FA1617	GA-442
C5082	GA-2217	MA1081	GA-381	EFA85	GA-50	FA1641	GA-1614
CA35124	GA-283	MA1083	GA-415	FA 1122	GA-432	FA1643	GA-130
MA 1095	GA-304	MA1085	GA-301	FA 1618	GA-394	FA1658	GA-158
MA 1118	GA-308	MA1088	GA-269	FA 1682	GA-433	FA1669	GA-472
MA 1145	GA-9948	MA1089	GA-216	FA 1908	GA-226R	FA1679	GA-479
MA1002	GA-165	MA1090	GA-387	FA 1910	GA-225	FA1680	GA-780
MA1003	GA-348	MA1091	GA-364	FA 1912	GA-1573	FA1683	GA-224
MA1004	GA-59	MA1092	GA-7167	FA 705	GA-3492	FA1688	GA-168
MA1006	GA-3916	MA1096	GA-1548	FA1	GA-77	FA1695	GA-395
MA1008	GA-6479	MA1097	GA-249	FA10	GA-70	FA1701	GA-132
MA1009	GA-273	MA1104	GA-771	FA1007	GA-734	FA1702	GA-134
MA1010	GA-322	MA1105	GA-597	FA1018	GA-74	FA1703	GA-165
MA1012	GA-158	MA1107	GA-510	FA1018	GA-381	FA1705	GAVW-621
MA1013	GA-174	MA1113	GA-596	FA1019R	GA-303	FA1706	GAVW-620
MA1014	GA-5056	MA1115	GA-324	FA1022	GA-75	FA1707	GAVW-624
MA1015	GA-8754	MA1116	GA-145	FA1023	GA-3300	FA1746	GA-4999
MA1016	GA-224	MA1117	GA-8121	FA1026	GA-3425	FA1750	GA-780
MA1018	GA-279	MA1121	GA-183	FA1032	GA-5056	FA1754	GA-1617
MA1020	GA-673R	MA1133	GA-443	FA1033	GA-176	FA1760	GA-281
MA1021	GA-70	MA1135	GAD-1	FA1040	GA-89	FA1762	GA-172
MA1024	GA-192	MA1138	GA-276	FA1043	GA-273	FA1765	GA-278R
MA1026	GA-263	MA1140	GA-380	FA1046	GA-174	FA1768	GA-59
MA1029	GA-217	MA1142	GA-74	FA1051	GA-275	FA-1769	GA-1804
MA1031	GA-1616	MA1143	GA-3424	FA1071	GA-274	FA1771	GA-771
MA1033	GA-414R	MA1144	GA-606	FA1072	GA-133	FA-1773	GA-1548
MA1034	GA-395	MA1147	GA-246	FA1073	GA-217	FA-1780	GA-1540
MA1035	GA-732R	MA1148	GA-1572	FA1085	GA-3916	FA1782	GA-1571
MA1036	GA-163	MA1150	GA-298	FA1086	GA-3814	FA-1785	GA-1572
MA1037	GA-490	MA1155	GA-4999			FA1786	GA-1544

MOTORCRAFT	GONHER	MOTORCRAFT	GONHER	INTERFIL	GONHER	AC DELCO	GONHER
FA1790	GA-5466	MFA9601ARC	GA-3083	CFI-1354	GAC-2295	FS10	GG-4
FA1799	GA-673R	MFA9601BOR	GAVW-625	CFI-1808	GAC-18	GF157	GG-20
FA1800	GA-348	MFA9601C1V1	GA-184	CFI-1K28CA	GAC-28	GF175	GGP-25
FA1812	GA-8606	MFA9601CAL	GA-489	CFI-2020	GAC-2275	GF417	GG-50
FA1830	GA-164	MFA9601CAP	GA-290	CFI-2727	GAC-27	GF427	GG-6
FA1837	GA-279	MFA9601EQU	GA-367	CFI-2789	GAC-89	GF434	GG-19
FA1850	GA-397	MFA9601JOU	GA-248	CFI-2S5A	GAC-13	GF441	GG-7
FA1855	GA-2173	MFA9601TOY	GA-464	CFI-2S5A	GAC-2274	GF451	GG-117
FA1856	GA-2123	MFA9601T11D6	GAD-116	CFI-3321	GAC-2296	GF455	GG-123
FA1857	GA-2159	MXS5X9601DA	GA-280	CFI-5058	GAC-50	GF466	GG-45
FA1861	GA-291	CABINA		CFI-6Q08	GAC-60	GF470	GG-16
FA1863	GAVW-1197			CFI-8092	GAC-92	GF471	GG-17
FA1864	GA-285			CFI-8220CA	GAC-2	GF479	GG-5 L
FA1874	GAVW-626			CFI-8713	GAC-2294	GF480	GG-8
FA1876	GAVW-623	AC DELCO	GONHER	CFI-8719	GAC-19	GF481	GG-46
FA-1883	GA-437	CF107	GAC-2286	CFI-93BW	GAC-9	GF483	GG-3728
FA-1884	GA-1542	CF110	GAC-13	CFI-9642	GAC-42	GF487	GG-87
FA1886	GA-550	CF110	GAC-2274	CFI-9696	GAC-2278	GF488	GG-1
FA1890	GA-1570	CF111	GAC-9	CFI-96FW	GAC-1	GF495	GG-94
FA1893	GA-222R	CF146	GAC-2	CFI-9812	GAC-81	GF500	GG-3
FA1897	GA-1541	CF147	GAC-99	CFI-999M	GAC-99	GF505	GG-1
FA1902	GA-439	CF157	GAC-2275	CFI-XF2Z	GAC-2286	GF510	GG-47
FA1904	GA-430	CF159	GAC-92	MANN	GONHER	GF512	GG-208
FA208	GA-7	CF162	GAC-2294	CFI-7850	GAC-2276	GF515	GG-42
FA244	GA-12	CF173	GAC-19	CU15001	GAC-2287	GF516	GG-255
FA31	GA-192	CF176	GAC-32	CU1919	GAC-19	GF517	GG-79
FA32	GA-3588	FRAM	GONHER	CU1936	GAC-27	GF518	GG-246
FA352	GAVW-10	CF10132	GAC-2294	CU2012	GAC-42	GF519	GG-408
FA36	GA-90	CF10133	GAC-2275	CU2131	GAC-2294	GF520	GG-226
FA36	GA-6620	CF10134	GAC-92	CU22007	GAC-89	GF522	GG-189
FA38	GAD-294	CF10135	GAC-13	CU2227	GAC-50	GF527	GG-261
FA39R	GA-55	CF10135	GAC-2274	CU2440	GAC-2295	GF529	GG-264
FA3R	GA-80	CF10140	GAC-99	CU2442	GAC-32	GF530	GG-67
FA519	GA-44	CF10285	GAC-19	CU2545	GAC-60	GF538	GG-251
FA52R	GA-303	CF10373	GAC-28	CU27008	GAC-2282	GF539	GG-204
FA576	GA-113	CF10375	GAC-2295	CU3337	GAC-18	GF540	GG-208
FA579	GA-100	CF10381	GAC-60	CU3554	GAC-1	GF547	GG-185
FA584	GA-2719B	CF10545	GAC-89	CU4251	GAC-2278	GF561	GG-64
FA588	GA-429	CF10546	GAC-2278	CU5257	GAC-9	GF561	GG-167
FA640	GA-3424	CF10550	GAC-27	CUK2939-1	GAC-28	GF562	GG-41
FA706	GA-3523	CF10627	GAC-2277	CUK3142	GAC-2	GF577	GG-243
FA72	GA-730	CF10729	GAC-50	MC 1002	GAC-2286	GF578	GG-66
FA721	GA-54	CF10775	GAC-32	MC1006-2	GAC-13	GF580K	GG-580
FA727	GA-101	CF11177	GAC-2287	MC1008	GAC-92	GF582	GG-177
FA75	GA-57	CF11183	GAC-2282	MC1012	GAC-99	GF589	GG-146
FA75	GA-327	CF11669	GAC-18	MC1013	GAC-2275	GF590	GG-151
FA943	GAVW-22	CF11671	GAC-2293	MOTORCRAFT	GONHER	GF598	GG-220
FA949	GA-271	CF11766	GAC-2276	FA 1626	GAC-9	GF600	GG-63
FA989	GA-3647	CF12160	GAC-2296	FP 7-A	GAC-1	GF604	GG-190
FA993	GA-4325	CF8046	GAC-9	COMBUSTIBLE		GF609	GG-190
FA994	GA-3681	CF8631	GAC-1			GF610	GG-65
M2NIU-9601-BD1	GA-284	CF8921A	GAC-2286			GF615	GG-220
MA1506	GA-302	CF9597A	GAC-2			GF620	GG-581
MFA1820	GA-248	INTERFIL	GONHER	AC DELCO	GONHER	GF625	GG-256
MFA1820	GA-490	CFI-10627	GAC-2277	19145567	GG-419	GF638	GG-7020
MFA1833	GA-289	CFI-11177	GAC-2287	ACD60	GG-48	GF638	GG-7019
MFA600	GA-301	CFI-1327	GAC-32	FS1	GG-5	GF642	GG-61
MFA96010DY	GA-383					GF643	GG-1872
MFA9601ALT	GA-1530					GF645	GG-266

FILTROS

EQUIVALENCIAS

AC DELCO	GONHER	FRAM	GONHER	FRAM	GONHER	INTERFIL	GONHER
GF655	GG-39	G10166	GG-101	G6680	GG-187	FGI-07	GG-19
GF656	GG-187	G10174	GG-183	G6826	GG-184	FGI-08	GG-170
GF661	GG-150	G10243	GG-1243	G6A	GG-4	FGI-09	GG-87
GF664	GG-207	G13	GG-3	G7018	GG-7018	FGI-10	GG-30
GF670	GG-227	G2	GG-124	G7019	GG-7019	FGI-100	GPP-111
GF673	GG-115	G20012	GG-64	G7072	GG-227	FGI-101	GP-4922
GF679	GG-137	G22	GG-19	G7092	GG-30	FGI-103	GG-262
GF683	GG-30	G3	GG-5	G7099	GG-82	FGI-105	GG-102
GF685	GG-72	G3359	GG-45	G7143	GG-64	FGI-106	GG-255
GF693	GG-99	G3499	GG-8	G7143	GG-167	FGI-11	GG-47
GF697	GG-184	G3499	GG-8 L	G7144	GG-116	FGI-111A	GG-243
GF702	GG-210	G3596	GG-87	G7146	GG-150	FGI-115	GG-581
GF-704	GG-308	G3606	GG-5 L	G7196	GG-7196	FGI-117	GG-249
GF705	GG-98	G3641	GG-79	G7248	GG-72	FGI-12	GG-64
GF723	GG-7196	G3713	GG-246	G7315	GG-66	FGI-121	GG-8
GF735	GG-160	G3727	GG-46	G7393	GG-255	FGI-122	GG-20
GF741	GG-307	G3728	GG-3728	G7398	GG-249	FGI-123	GG-123
GF749	GG-92	G3736	GG-189	G7399	GG-99	FGI-125	GG-50
GF752	GG-268	G3744	GG-261	G7404	GG-94	FGI-13	GG-256
GF755	GG-84	G3746	GG-226	G7416	GG-84	FGI-132	GG-82
GF757	GG-249	G3747	GG-408	G7428	GG-268	FGI-133	GG-986
GF763	GG-7018	G3769	GG-42	G7596	GG-92	FGI-134	GG-265
GF794	GG-290	G3802	GG-47	G7599	GG-160	FGI-135A	GG-267
GF796	GG-101	G3829	GG-251	G7609	GG-267	FGI-136	GG-252
GF802	GG-351	G3850	GG-1872	G7610	GG-265	FGI-137	GG-266
GF809	GG-164	G3893	GG-62	G7649	GG-239	FGI-138A	GG-195
GF810	GG-164	G3895	GG-264	G7740	GG-290	FGI-143	GG-115
GF822	GG-299	G3897	GG-67	G7760	GG-104	FGI-145	GG-268
GF829	GG-845	G3968	GG-190	G7770	GG-164	FGI-146	GG-116
GF831	GG-209	G4164	GG-1	G77U	GG-29	FGI-147	GG-117
GF832	GG-986	G4715	GG-204	G8018	GG-986	FGI-148	GG-124
GF849	GG-95	G4774	GG-208	G8075	GG-164	FGI-14A	GG-95
GF850	GG-267	G4775	GG-208	G8190	GG-95	FGI-15	GG-72
GF851	GG-265	G4777	GG-63	G8219	GG-266	FGI-150	GG-131
GF852	GG-104	G4841	GG-185	G8279	GG-233	FGI-151	GG-164
GF855	GG-102	G4894	GG-98	G8414	GG-283	FGI-153	GG-146
GF859	GG-206	G5237	GG-137	G8757	GG-210	FGI-157	GG-150
GF886	GG-239	G5738	GG-252	G8861A	GG-307	FGI-16	GG-67
TP1193	GP-4922	G5774	GG-351	G9041	GG-105	FGI-160	GG-186
TP1274	GPP-111	G5857	GG-291	G9279	GG-7020	FGI-165	GG-167
		G5870	GG-102	G9343	GG-308	FGI-166	GG-177
		G5982	GG-206	G9344	GG-209	FGI-168	GG-106
		G5995	GG-64	G9370	GG-845	FGI-17	GG-32
		G6344	GG-39	G9611	GG-915	FGI-174	GG-8 L
		G6348	GG-41	G9729	GG-355	FGI-176	GG-290
		G6348	GG-256	G9960	GG-419	FGI-18	GG-1872
		G6400	GG-106	G9961	GG-369	FGI-180	GG-1
		G6412DP	GG-65	K10826	G-450	FGI-186	GG-161
		G6429	GG-207	P4005	GPP-111	FGI-19	GG-46
		G6476	GG-220	P5138	GP-4922	FGI-191A	GG-210
		G6507DP	GG-581	P9865	GGP-25	FGI-194	GG-206
		G6534	GG-190	PS10265	GP-701	FGI-20	GG-580
		G6561	GG-243			FGI-200A	GG-105
		G6563	GG-61	INTERFIL	GONHER	FGI-201	GG-169
		G6613	GG-580	FGI-01	GG-29	FGI-206A	GG-209
		G6674	GG-220	FGI-02	GG-42	FGI-207A	GG-308
		G6676	GG-115	FGI-03	GG-25	FGI-21	GG-92
		G6677	GG-146	FGI-04	GG-5 L	FGI-212A	GG-915
		G6678	GG-151	FGI-06	GG-62	FGI-213A	GG-307

INTERFIL	GONHER.	INTERFIL	GONHER.	MANN	GONHER.	MANN	GONHER.
FGI-214	GG-283	FGI-56	GG-1	33138	GP-4922	33487	GG-41
FGI-215	GG-220	FGI-57	GG-4	33140	GPP-612	33487	GG-256
FGI-219	GG-190	FGI-58	GG-6	33142	GG-298	33489	GG-177
FGI-22	GG-61	FGI-59	GG-7	33150	GG-206	33500	GG-151
FGI-221	GG-164	FGI-60	GG-16	33153	GG-189	33500	GG-237
FGI-222	GG-182	FGI-61	GG-17	33161	GG-251	33500	GG-7196
FGI-227	GG-419	FGI-62	GG-79	33183	GG-290	33500	GG-227
FGI-235	GG-97	FGI-64	GG-189	33199	GG-64	33502	GG-185
FGI-238	GG-101	FGI-65	GG-190	33199	GG-167	33521	GG-102
FGI-23A	GG-3728	FGI-72	GG-204	33203	GG-207	33553	GG-164
FGI-24	GG-3	FGI-73	GG-207	33204	GG-208	33554	GG-164
FGI-242	GG-369	FGI-74	GG-208	33223	GG-220	33559	GG-160
FGI-244	GG-351	FGI-76	GG-298	33227	GG-7020	33577	GG-267
FGI-245	GG-355	FGI-84	GG-220	33235	GG-182	33579	GG-266
FGI-246	GG-183	FGI-85	GG-151	33243	GG-101	33580	GG-233
FGI-25	GG-7020	FGI-86	GG-408	33257	GG-239	33585XE	GS-1261
FGI-26	GG-66	FGI-86	GG-246	33267	GG-580	33595	GG-986
FGI-263	GP-16405-02N10	FGI-88	GG-226	33271	GG-20	33615	G-450
FGI-264	G-229	FGI-90	GG-227	33272	GG-351	33643	GG-420
FGI-265	GS-1261	FGI-95	GG-261	33275	GG-204	33686	GG-151
FGI-267D	GP-857	FGI-98	GG-237	33276	GG-226	33814	GG-1243
FGI-268	GG-103	FGI-99	GG-239	33277	GG-226	33826	GG-105
FGI-27	GG-63	GFI-298	GG-1243	33279	GG-261	33826	GG-95
FGI-272	GP-16405-01T70	MANN	GONHER.	33284	GG-146	33833	GG-107
FGI-275	GG-420	24006	GGP-25	33285	GG-184	33850	GG-419
FGI-276	GG-107	33001	GG-4	33293	GG-30	33878	GG-164
FGI-276D	GPP-612	33001	GG-117	33294	GG-220	33888	GG-355
FGI-277	GG-411	33002	GG-3	33295	GG-150	33905	GG-233
FGI-278D	GP-701	33003	GG-5	33296	GG-1872	33925	GG-164
FGI-28	GG-251	33011	GG-1	33298	GG-115	33929	GG-283
FGI-280	G-723	33022	GG-94	33300	GG-92	33934	GP-701
FGI-29	GG-98	33023	GG-63	33301	GG-84	33950	G-1048
FGI-299A	GG-845	33028	GG-98	33302	GG-7019	33957	GG-307
FGI-30	GG-41	33031	GG-1	33310	GG-255	WF10018	GG-265
FGI-300D	G-434	33032	GG-124	33311	GG-66	WF8034	GG-291
FGI-301D	G-7159	33032	GG-5 L	33316	GG-99	WF8170	GG-411
FGI-303D	GPP-5773	33037	G-434	33318	GG-72	WF8229	GG-169
FGI-319	GG-233	33038	GG-50	33319	GG-187	WF8251	GG-915
FGI-32	GG-45	33044	GG-6	33321	GG-67	WF8300	G-229
FGI-33	GG-1992	33046	GG-19	33323	GG-61	WF8310	GG-369
FGI-338D	G-1048	33048	GG-7	33324	GG-65	WF8334	GG-161
FGI-339D	G-450	33050	GG-123	33325	GG-249	WF8358	GP-857
FGI-34	GG-5	33051	GG-16	33330	GG-190	WF8366	G-723
FGI-35	GG-7019	33052	GG-17	33335	GG-7018	WF8392	G-7159
FGI-36	GG-7018	33053	GG-45	33343	GP-16405-02N10	WF8439	GPP-5773
FGI-37	GG-137	33054	GG-8	33346	GG-95	MOTORCRAFT	GONHER.
FGI-38A	GG-84	33066	GG-208	33347	GG-104	FG805	GG-117
FGI-39A	GG-99	33066	GG-207	33348	GG-48	4103735	GG-915
FGI-40	GG-185	33078	GG-106	33409	GG-210	CFG1004	GG-243
FGI-41A	GG-104	33079	GG-42	33424	GG-308	CFG1005	GG-61
FGI-42	GG-39	33081	GG-87	33425	GG-64	EFG107	GG-251
FGI-43	GG-264	33082	GG-8 L	33454	GG-39	EFG113	GG-226
FGI-44	GG-65	33097	GG-47	33460	GG-190	EFG22	GG-246
FGI-45	GG-184	33097	GG-82	33463	GG-264	EFG307	GPP-111
FGI-47	GG-94	33099	GG-268	33477	GG-137	EFG41	GG-189
FGI-48	GG-7196	33100	GG-845	33481	GG-46	EFG51	GG-5
FGI-50	GG-187	33128	GPP-111	33483	GG-3728	F81Z9155AC	GG-986
FGI-52	GG-160	33129	GG-209	33484	GG-581	FD4596	G-862T
FGI-53A	GG-111			33486	GG-79		

FILTROS

EQUIVALENCIAS

FILTROS

EQUIVALENCIAS

MOTORCRAFT	GONHER.	MOTORCRAFT	GONHER.
FD-4609	G-1048	FG938	GG-190
FD-4615	G-450	FG946	GG-79
FD802	GG-3	FG978	GG-72
FD82	GG-48	GF693	GG-99
FG 1004	GG-210	GF755	GG-84
FG 1036	GG-308	MEFG6	GG-82
FG 858	GG-261	MFG1014	GG-195
FG 883	GG-420	MFG1014	GG-95
FG1	GG-20	MFG1018	GG-104
FG100	GG-4	MFG1019	GG-265
FG1006	GG-47	MFG1020	GG-111
FG1011	GG-101	MFG1021	GG-98
FG-1026	GG-66	MFG1022	GG-266
FG103	GG-87	MFG1026	GG-290
FG1070	GG-39	MFG1032	GG-106
FG1072	GG-307	MFG1069	GG-64
FG1087	GG-291	MFG1085	GG-160
FG1121	GG-169	MFG1086	GG-161
FG14	GG-19	MFG11	GG-5 L
FG21	GG-1	MFG-1123	GG-419
FG34	GG-7	MFG12	GG-7019
FG35	GG-6	MFG157	GG-298
FG66	GG-32		
FG7	GG-1		
FG775	GG-16		
FG776	GG-17		
FG77U	GG-29		
FG788	GG-123		
FG790	GGP-25		
FG797	GG-8		
FG803	GG-208		
FG805	GG-45		
FG840	GG-42		
FG849	GG-8 L		
FG851	GG-46		
FG851	GG-580		
FG852	GG-3728		
FG856	GG-207		
FG858	GG-408		
FG862	GG-30		
FG872	GG-1872		
FG877	GG-239		
FG881	GG-92		
FG885	GG-185		
FG887	GG-63		
FG888	GG-264		
FG89	GG-25		
FG892	GG-65		
FG893	GG-190		
FG895	GG-94		
FG896	GG-268		
FG9	GG-50		
FG900	GG-204		
FG913	GG-220		
FG919	GG-184		
FG925	GG-115		
FG926	GG-41		
FG926	GG-256		
FG927	GG-187		

Instrucciones para una correcta Instalación de filtros sellados.

Los filtros son las piezas que más seguido se sustituyen de su vehículo. Para asegurar el rendimiento normal del filtro, prevenir costosos daños a su motor y facilitar los próximos servicios, al reemplazar un filtro, siga los pasos que a continuación se describen:

1.- El motor debe estar tibio; levante el cofre del motor de su vehículo y remueva el tapón de admisión de aceite.

2.- Levante el vehículo tomando las medidas de seguridad apropiadas y desatornille el tapón del cárter o depósito; permita que escurra todo el aceite, vuelva a instalar el tapón del cárter, no sin antes inspeccionar el estado de las juntas o empaques y reemplácelas si es necesario.

3.- Remueva el filtro usado, utilizando la herramienta apropiada; en algunos casos y dada la incomodidad de la instalación, se requerirá del uso de herramientas especiales que evitarán que el filtro se dañe, haciendo difícil su remoción.



4.- Limpie con un trapo limpio la base del motor y asegúrese de que el empaque o junta anterior no se quede pegada a la base; no use estopa, aplique una película de aceite limpio al nuevo empaque. Nota: Nunca use grasa lubricante en el empaque u otro material.

5.- Instale el nuevo filtro cuidando de no trasroscarlo. En las unidades grandes, puede ser necesario llenar el filtro con aceite limpio antes de instalarlo; verifique las recomendaciones del manual del propietario. Después de que el empaque del filtro tope con la base del motor, apriételo a mano de acuerdo a las instrucciones que se encuentran en el filtro o en el empaque del mismo producto.

No sobre apriete, ni utilice herramientas para apretar.

Importante: Antes de efectuar cualquier cambio de aceite o filtros, verifique que tenga las herramientas y conocimientos apropiados; de no tenerla, visite a su centro de servicio o mecánico de confianza. Así evitará daños y demoras.

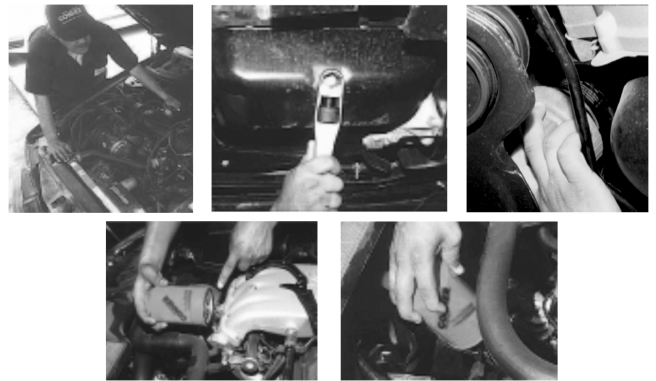

6.- Baje el vehículo a nivel del suelo y llene el cárter o depósito con aceite limpio hasta el nivel recomendado; vuelva a instalar el tapón de admisión de aceite. Encienda el motor y espere unos segundos a que la presión se normalice. Si el indicador de presión no indica la normalización o la luz de advertencia en el tablero no se apaga, apague el motor y revise la instalación.

7.- Apague el motor y cheque el nivel de aceite; rellene si es necesario.

8.- Encienda el motor por 5 minutos y verifique que no haya fugas alrededor del filtro, el tapón del cárter o depósito y las conexiones existentes.

9.- Apague el motor y cierre el cofre.

*No tire el filtro usado y aceite sucio en el drenaje o en la tierra, observe las disposiciones ecológicas aplicables en su región.

*Nunca deje encendida la unidad sin vigilancia, después de hacer un cambio de aceite o filtros, pueden presentarse fugas de lubricante, sin percatarse de ellas, llegando a ser de resultados catastróficos.



Strao Wrench
Tipo Sincho

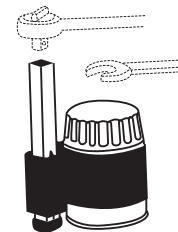

Heavy Duty Wrench
Servicio Pesado

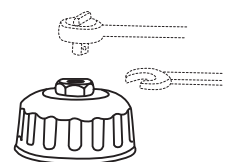

Cup Wrench
Tipo Copa

Problemas con la luz de aviso para la presión de aceite.

La mayor parte de los automotores actuales utilizan una luz de aviso, montada en el panel de instrumentos para brindar al conductor una señal visual de la baja presión de aceite. La baja presión es importante, dado que el aceite "bajo presión" es necesario para separar adecuadamente las partes muy cargadas del motor y evitar un desgaste excesivo.

La luz de aviso está conectada en serie con un interruptor de presión de aceite, como se ilustra en la figura 1. El interruptor de presión contiene contactos eléctricos que están en posición cerrada, cuando la presión de aceite es inferior a 5 lbs/pulg².

Cuando el motor no está funcionando y el encendido está conectado a la luz de aviso, queda conectada.

Cuando el motor es puesto en marcha, la presión de aceite comprime el diafragma en el interruptor de presión, abriendo los contactos y haciendo que la luz se apague.

Si la luz de aviso permanece conectada durante más de 5 segundos, después de que el motor ha sido puesto en marcha, apáguelo inmediatamente; el nivel de aceite deberá ser controlado y puesto en situación normal. Si la luz de aviso continúa conectada cuando el nivel de aceite es normal, entonces podrá existir uno de los siguientes problemas:

- 1.- El interruptor de presión puede haber fallado.
- 2.- El cableado entre el interruptor de presión y la luz de aviso puede estar conectado a tierra.
- 3.- La bomba puede estar descebada debido a una falla o a un filtro (o malla) de succión saturado.
- 4.- La válvula reguladora de presión puede estar abierta y retornar el aceite nuevamente al cárter.

En algunos motores, el filtro está montado en una posición que permite que el aceite drene nuevamente al cárter cuando el motor es detenido. Éste sería el caso del filtro ilustrado en la figura 2, donde está en posición horizontal, situado sobre el nivel de aceite en el cárter. Dado que el filtro acumula hasta 0.94 litros de aceite, toma aproximadamente cinco segundos para que la bomba lo llene después de que el motor ha sido puesto en marcha; durante este lapso, la luz de aviso queda conectada.

Para evitar que el motor funcione sin presión de aceite durante ese período, los filtros diseñados para esas posiciones contienen una válvula anti-drenaje. Esta válvula tiene actualmente la forma de una empaquetadura de neopreno que permite el libre flujo de aceite, a través del filtro en la dirección normal, pero cuando el motor está "parado", evita que el aceite se descargue en el cárter. Si la luz de aviso permanece conectada durante periodos más prolongados, después de que el filtro ha estado usándose en el automotor durante algún tiempo, se recomienda su reemplazo.

Bajo algunas condiciones, la luz de aviso puede parpadear cuando el motor está funcionando. Esto sucede generalmente cuando el vehículo está doblando o situado sobre una cuesta relativamente empinada. Si se produjese un parpadeo bajo estas condiciones, se debe a que el nivel de aceite es bajo, y el filtro (malla) de la bomba ya no está totalmente sumergido. El nivel de aceite debe ser inmediatamente llenado a la situación normal.

En síntesis, la luz de aviso de la presión de aceite brinda una Información vital al conductor. Si la luz permanece conectada o aún parpadea cuando el motor está funcionando, debe ser desconectada inmediatamente e Investigada la causa.

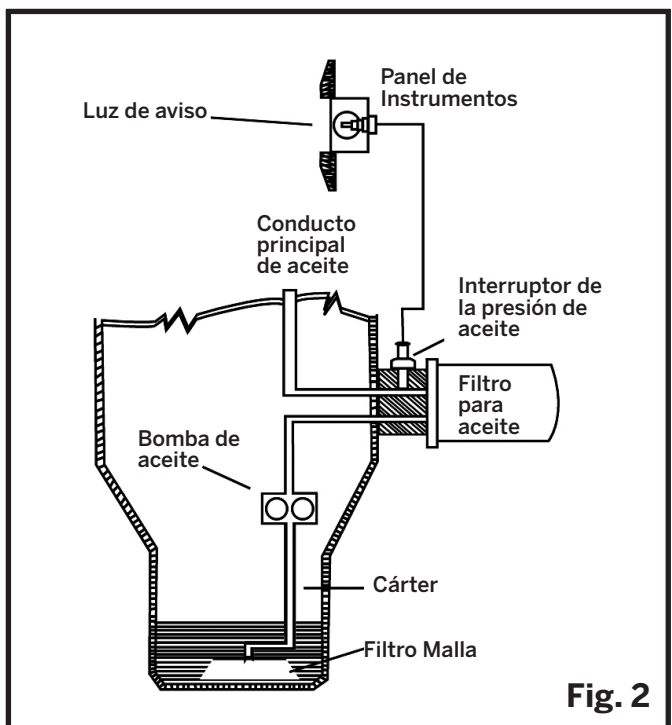
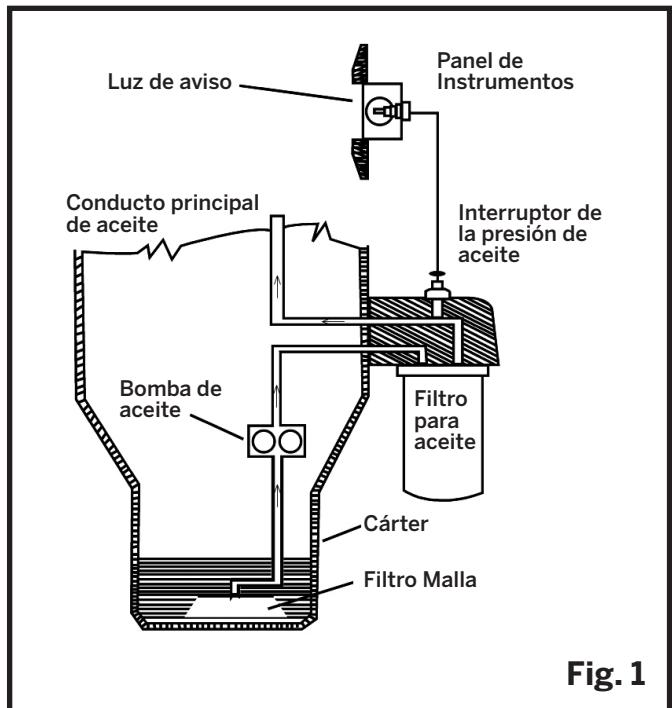

Pérdida de alimentación en la bomba de aceite.

Inmediatamente después de un cambio de aceite, uno de los asuntos que más confusión enfrentan los mecánicos profesionales o personas interesadas en hacer sus propias reparaciones, es la dificultad de recuperar la presión del aceite en la bomba a su nivel normal de operación.

Aunque no ocurre con frecuencia, es muy posible que la bomba de aceite pueda perder su alimentación o ceba durante el cambio de aceite.

Cuando se drena el aceite usado del motor (Fig. 1), puede también vaciarse el tubo de succión y posiblemente hasta la bomba. Cuando se agrega el aceite nuevo al cárter, se ahoga de nuevo la entrada del tubo de succión de la bomba de aceite, sin lograr desplazar el aire atrapado en el tubo. Éste causará cavitación en la bomba e impedirá el flujo de aceite, por lo que no habrá presión en el motor y en sus indicadores.

Muchos instaladores, al notar esto, culpan al filtro de aceite (Fig. 2), suponiendo que está tapado y bloqueando el flujo. Como el instalador sospecha del filtro, instalará un segundo filtro; a veces, esto resuelve el problema porque el aire atrapado fue descargado cuando se retiró el primer filtro. Por lo tanto, se fortalece la sospecha de que el filtro era el causante de la falla.

Sin embargo, el filtro de aceite no era el problema y en muchos casos hay una solución más sencilla.

Si después del cambio del filtro y de aceite, la luz roja o el indicador de presión baja continúa por diez segundos, es recomendable apagar el motor, retirar el filtro de aceite (Fig. 3), y usando una pistola de aceite cargada con aceite de motor, inyectar varias veces en la salida de la base del filtro de aceite en el motor (Ésta será la abertura al lado del perno roscado; no ayudará en nada inyectar aceite en el perno roscado). Luego, llene el filtro con aceite de motor nuevo y reinstale. Encienda el motor y verifique si la presión de aceite se normaliza. En la mayoría de los casos, el problema estará solucionado; sin embargo, si la falla persiste, por ningún motivo se deberá permitir que el motor funcione por más de 10 segundos sin presión de aceite. Use un reloj para cronometrar los diez segundos y estar seguro del lapso del tiempo. En ciertos casos, la bomba utilizará cada uno de los diez segundos para recuperar el flujo de aceite. Si esto falla de nuevo, retire el filtro y encienda el motor hasta que se derrame el aceite de la bancada del motor. No continúe encendiendo el motor por más de diez segundos a la vez. Cuando el aceite se derrame, reinstale el filtro (Fig. 4), corrija el nivel del aceite y vuelva a encender el motor. La presión deberá volver a su nivel normal.

Nota: A veces se puede evitar este problema reduciendo el tiempo que drena el aceite.

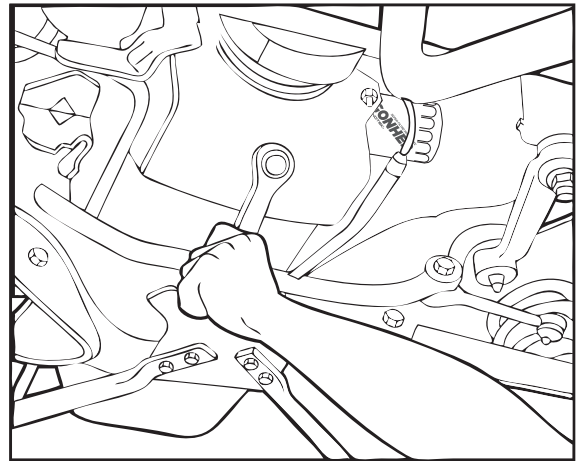

Fig. 1

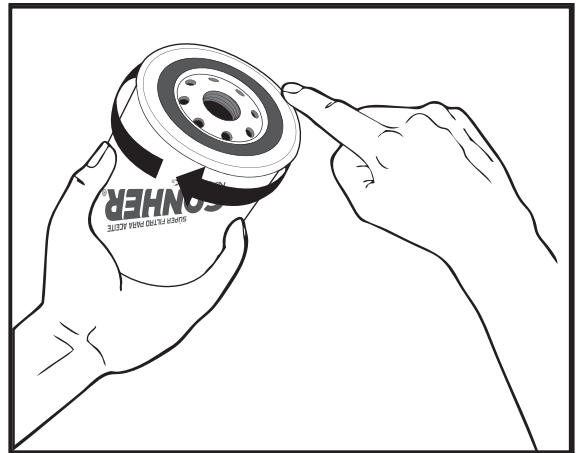

Fig. 2

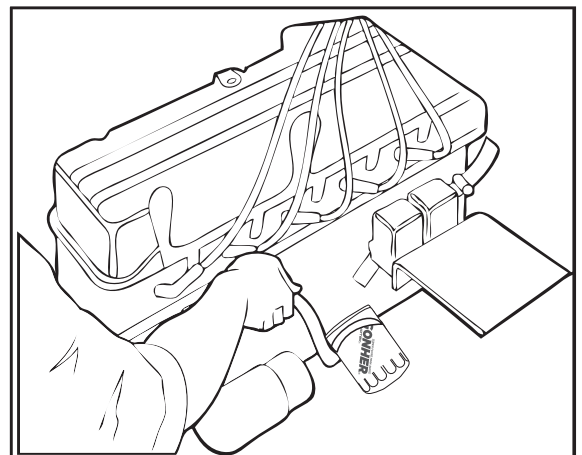

Fig. 3

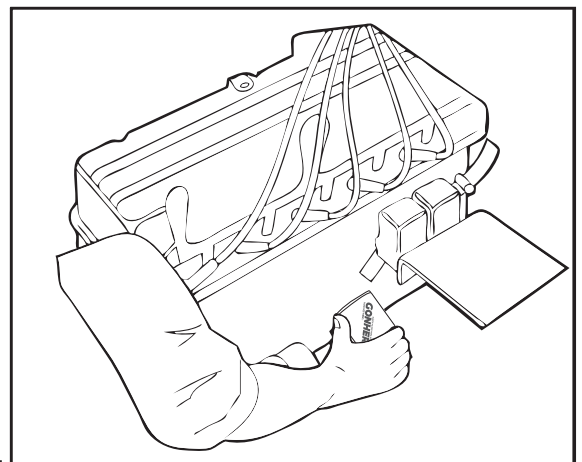

Fig. 4

Deficiencias más usuales provocadas por la válvula reguladora de presión.

Filtros para aceite lubricante con presión excesiva.

Todos los fabricantes de filtros han recibido alguna vez un filtro devuelto por un cliente con una sobrepresión excesiva. Con frecuencia, el filtro deformado es la única indicación que tiene el dueño del automóvil para saber que se presentó un problema en su sistema de aceite lubricante.

Es posible que el filtro dañado no se haya advertido hasta que se quitó durante el siguiente cambio de aceite programado. Sin embargo, si la presión fue suficiente como para romper la junta o desenrollar la costura engargolada, el dueño del automóvil habrá experimentado problemas inmediatos y costosos.

Con la "evidencia" en sus manos, tiende a echarle la culpa al filtro dañado. No es sorprendente que él esté un poco más que molesto cuando el fabricante del filtro niega cualquier responsabilidad por el daño. Entonces, ¿qué fue lo que causó la presión excesiva?. Echar una mirada a la forma como funciona el sistema de aceite lubricante, mostrará que la presión del aceite es creada por la bomba. El límite superior de ésta está controlado por una válvula reguladora de presión que generalmente es una parte integral de la bomba.

La figura 1 es un diagrama simplificado del sistema de aceite lubricante, que muestra bomba, válvula reguladora, filtro y rodamientos. La bomba suministra suficiente flujo para lubricar los rodamientos y otras partes móviles del motor. Este aceite debe estar bajo presión para separar adecuadamente las partes fuertemente cargadas del motor y evitar el desgaste excesivo. El objeto de la válvula reguladora es proporcionar esta presión, que en la mayoría de los automóviles de pasajeros se encuentra entre los 40 y 60 PSI (libras por pulgada cuadrada).

La válvula reguladora está formada por una bola o émbolo que regula la presión con la ayuda de un resorte. El resorte está calibrado de tal forma que el émbolo se levante de su asiento cuando la presión de aceite llega al nivel deseado. Una vez que la válvula está abierta, la presión permanece bastante constante con sólo cambios ligeros que se presentan cuando varía la velocidad del motor.

El filtro y los otros componentes en el sistema de lubricación están sujetos a la presión establecida por la válvula reguladora. Si esta presión es excesiva, se presentará el daño del filtro. Esto es lo que no comprenden las personas que no están familiarizadas con los sistemas de lubricación.

¿Qué es lo que puede hacer que la presión en el sistema exceda el ajuste de la válvula reguladora? La válvula puede estar pegada en la posición cerrada o está lenta para moverse a la posición abierta después de haber arrancado al motor. La figura 2 muestra el sistema funcionando con la válvula reguladora pegada en la posición de cierre. Bajo estas condiciones, la presión se acumula igualmente en todos los componentes en el sistema hasta que algo sucede para aliviar la presión.

Si la válvula reguladora se despega, la presión regresará a normal. Si permanece pegada, algo se tiene que romper.

La presión de operación normal no origina deformación permanente en el cuerpo del filtro. Cuando la presión del sistema llega a 150 PSI debido a una válvula reguladora defectuosa, la mayoría de los filtros se deforman permanentemente. Bajo esta presión, la junta generalmente no se romperá y la costura engargolada permanecerá intacta.

Si la válvula reguladora continúa pegada, la presión se incrementará más y la junta entre el filtro y la base puede romperse. Esto probablemente hará que se pierda todo el aceite en el sistema. Si el filtro se ha instalado de manera demasiado apretada, la junta no se romperá y la costura engargolada se desenrollará conforme la presión continúa aumentando.

Si el cliente está alerta y para el motor a la primera indicación de problema (lámpara roja en o reducción en la presión de aceite) él puede limitar su pérdida a un trabajo de arrastre, cambio de aceite y filtro nuevo.

Si conduce hasta el taller más próximo, probablemente quemará el motor debido a la falta de aceite. El punto principal es que el filtro deformado no es la causa de esta presión excesiva, sino que es la víctima de una válvula reguladora defectuosa.

El cliente preguntará si un filtro que haya estado completamente tapado podría haber causado las condiciones de sobrepresión en el sistema. La respuesta es no.

Si la válvula reguladora está funcionando correctamente, mantendrá la presión en el filtro a 40 ó 60 PSI incluso si el filtro está tapado.

Resumiendo, si un filtro se deforma debido a sobre presión en el sistema, la falla reside en la válvula reguladora y no en el filtro.

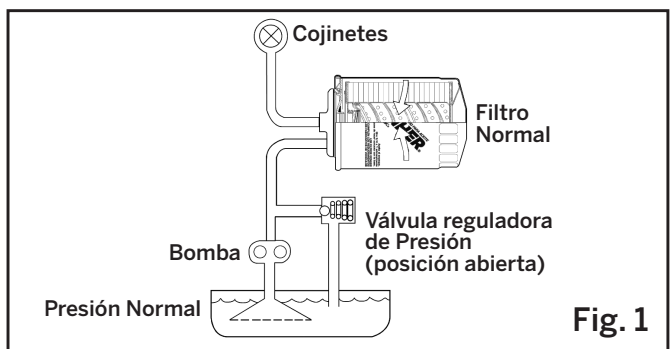

Fig. 1

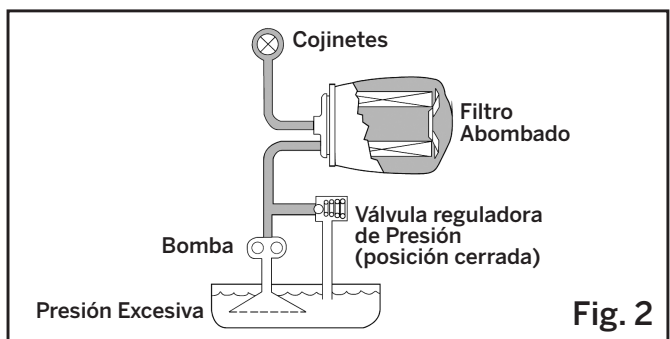

Fig. 2

Filtros con soporte central o elemento colapsado.

COLAPSO:

Término usado para describir el daño ocasionado a un filtro en cuya apariencia se observa un aplastamiento del soporte central para el medio filtrante (figura 1).

Cuando encontramos un elemento filtrante donde ha ocurrido un colapso, la tendencia natural, es pensar que algo dentro del filtro no funcionó de manera correcta, siendo éste, el causante de los daños ocasionados. Generalmente ésta no es la causa de los daños, sino el síntoma de un problema dentro del motor.

Los motores automotrices incorporan una válvula check o válvula de alivio entre la entrada y salida del flujo total de aceite, esta válvula permite la continuidad de la lubricación creando un by-pass por donde el aceite circula sin pasar por el filtro directamente, dentro del motor cuando existe una restricción significativa en la presión de aceite, debido a la saturación del filtro o al arranque en frío (figura 2).

Generalmente los fabricantes de motores automotrices, han diseñado estas válvulas de alivio para abrir cuando la presión diferencial excede las 10 PSI, otros utilizan presiones de hasta por 30 PSI. Así algunos fabricantes de motores diseñan esta válvula integrada en el monoblock, mientras que otros prefieren que sea el filtro el que la lleve.

Los filtros automotrices han sido diseñados para soportar presiones significativamente superiores a la presión de operación normal de trabajo sin colapsarse, de ahí que cuando un filtro sufre un colapso, generalmente es el resultado de una obstrucción o de un mal funcionamiento de la válvula de alivio.

En ocasiones no es suficiente la obstrucción de la válvula para colapsar el filtro. La válvula reguladora de presión también puede obstruirse dando como resultado un incremento de presión en el flujo a través del filtro, aunque esta condición puede ser momentánea, rápidamente puede colapsarse el filtro si la válvula de alivio no puede liberar la presión excedente, debido al cambio repentino y por arriba de la presión de operación normal de trabajo.

Un filtro colapsado puede ocasionar la pérdida de la filtración y lubricación del motor; si esta condición se presenta, las válvulas reguladoras de presión y de alivio deberán ser inspeccionadas y reparadas o sustituidas por nuevas tan pronto como sea posible, previendo que se presenten daños mayores.

El mal funcionamiento de la válvula de alivio, así como de la válvula reguladora de presión y el subsiguiente colapso del filtro, puede no causar daños notables en el motor, pero en ocasiones tiene resultados catastróficos, llegando a producir serios sobrecalentamientos e inclusive desvielmientos por falta de una lubricación.

Las causas frecuentes que producen el mal funcionamiento tanto de la válvula reguladora de presión, como de la válvula de alivio, pueden ser:

- 1.- Superficies pegajosas causadas por el arranque en frío o por el uso de aceites altamente viscosos.
- 2.- Aceites excesivamente contaminados asociados a la condensación, mezcla de refrigerantes y la oxidación del propio aceite.
- 3.- Descuido del usuario al prolongar los intervalos para el cambio de aceite y filtros recomendados por el fabricante.
- 4.- Residuos de carbón arenoso que temporalmente atascan el libre movimiento de los componentes de la válvula.
- 5.- Repentinos cambios de aceleración con la presencia de cualquiera de las condiciones arriba mencionadas.
- 6.- La combinación de cualquiera de las causas anteriores.

Descubrir un filtro colapsado, es un llamado para inspeccionar el estado de las válvulas de alivio y reguladora de presión en el motor, así como para revisar el funcionamiento del motor y la ejecución de los programas de mantenimiento.

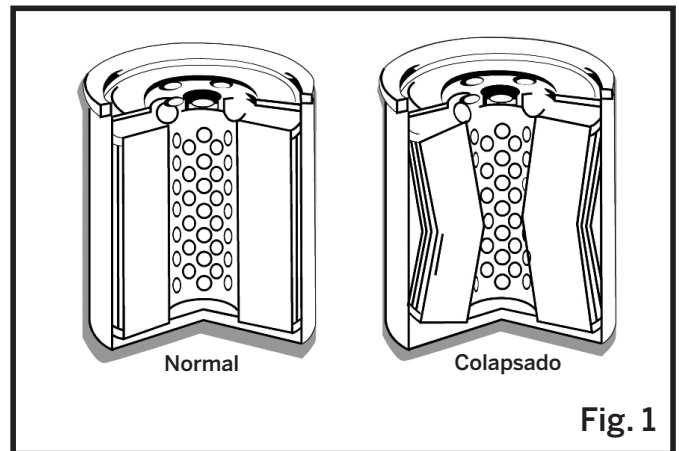

Fig. 1

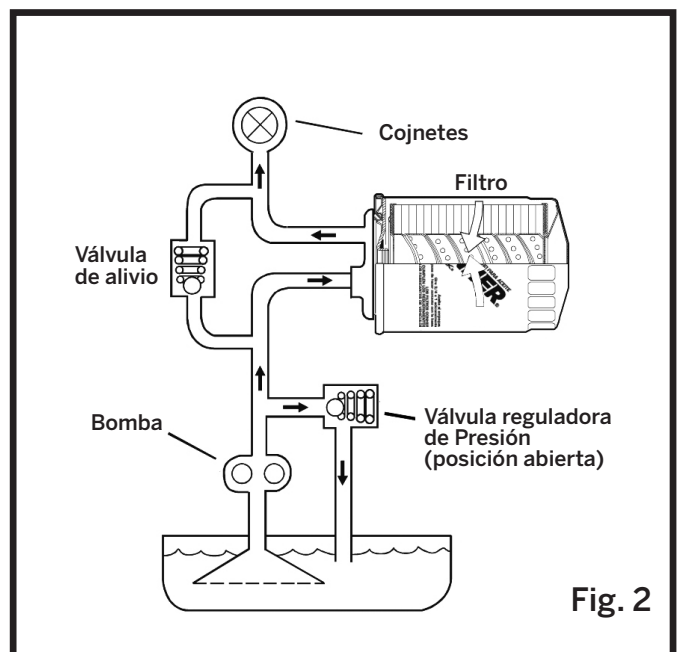

Fig. 2

GARANTÍA

GONHER DE MÉXICO, S.A. DE C.V., garantiza los filtros contra cualquier defecto de fabricación, durante el periodo de mantenimiento recomendado por los fabricantes del equipo en el cual se use filtros de la marca registrada **GONHER**.

En el caso de un daño al motor atribuible en forma directa a falla de un filtro **GONHER** que ha sido instalado en forma correcta, **GONHER DE MÉXICO** pagará la reparación a una condición equivalente a la que existía antes de la falla. El daño deberá ser comprobado por un técnico autorizado por **GONHER DE MÉXICO** antes de cualquier reparación.

GONHER DE MÉXICO no es responsable por cualquier otro daño o perjuicio.

Las garantías otorgadas por fabricantes de equipos nuevos permanecen vigentes cuando se instalen filtros **GONHER** y tendrá vigencia por los kilómetros u horas recomendados por los mismos.

Esta garantía podrá hacerse válida en **GONHER DE MÉXICO, S.A. DE C.V.**, cualquiera de los distribuidores autorizados o dirija un correo a stproducto@grupogonher.com

Gonher filters are guaranteed to be free from any defect in workmanship and materials during the service life recommended and if found to be defective will be replaced. Vehicle and engine warranties can not be voided solely due the use of **GONHER** filters.

In event of engines failure directly attributable to a **GONHER** filter defect, **GONHER** will restore engine to a condition equivalent to that existing just before the failure. However, **GONHER** is not liable for any other losses or expenses incurred due such defect.

GONHERMEX DE MÉXICO, S.A. DE C.V.
Av. Manuel Ordoñez No. 600 C.P. 66350
Santa Catarina, N.L., México
Tel: (81) 8153-31-00



MÁXIMA FÓRMULA



GONHER[®]
AUTOPARTES

GRUPO **GONHER**®



F11022021

EMPRESA 100% MEXICANA

grupogonher.com

